



Transmission Facility Interconnection
Requirements

Document #: EU00551257
Revision #: 1
Effective Date: 04/05/2023
Page 1 of 107



PPL ELECTRIC UTILITIES
TRANSMISSION FACILITY INTERCONNECTION REQUIREMENTS

Effective Date: April 5, 2023



PPL Electric Utilities Corporation
Transmission Facility Interconnection Requirements

Approvals:



Name	Signature	Date of Signature
Prepared by: Nicholas Pratt	 <small>Nicholas Pratt (Mar 23, 2023 14:15 EDT)</small>	03/23/2023
Reviewed by: Colleen Kester	 <small>Colleen Kester (Mar 24, 2023 12:28 EDT)</small>	03/24/2023
Approved by: Joe Lookup	 <small>Joseph Lookup (Mar 24, 2023 14:54 EDT)</small>	03/24/2023



Table of Contents

1	PURPOSE AND SCOPE	5
2	DEFINITIONS	6
3	INTERCONNECTION PROCEDURES	7
3.1	PROCEDURES FOR COORDINATED STUDIES OF NEW OR MATERIALLY MODIFIED EXISTING.....	7
3.2	PROCEDURES FOR NOTIFYING THOSE RESPONSIBLE FOR THE RELIABILITY OF AFFECTED SYSTEM(S) OF NEW OR MATERIALLY MODIFIED EXISTING INTERCONNECTIONS	8
3.3	PROCEDURES FOR CONFIRMING WITH THOSE RESPONSIBLE FOR THE RELIABILITY OF AFFECTED SYSTEMS OF NEW OR MATERIALLY MODIFIED TRANSMISSION FACILITIES ARE WITHIN A BALANCING AUTHORITY AREA’S METERED BOUNDARIES	8
3.4	DATA REQUIRED TO PROPERLY STUDY INTERCONNECTION.....	8
4	TRANSMISSION PLANNING AND EVALUATION REQUIREMENTS	9
4.1	VOLTAGE LEVEL AND MW AND MVAR CAPACITY OR DEMAND AT THE POINT OF INTERCONNECTION	9
4.2	VOLTAGE, REACTIVE POWER, AND POWER FACTOR CONTROL.....	9
4.3	POWER QUALITY IMPACTS	10
5	GENERATION CONNECTION TO A TRANSMISSION LINE	11
5.1	TRANSMISSION LINE > 200 kV	11
5.2	TRANSMISSION LINE ≤ 200 kV	12
6	END-USER CONNECTION TO A TRANSMISSION LINE	13
6.1	TRANSMISSION LINE > 200 kV	13
6.2	TRANSMISSION LINE ≤ 200 kV	14
7	CONNECTING TO AN EXISTING PPL EU SUBSTATION	16
7.1	APPLICABILITY	16
7.2	SUBSTATION CONNECTION > 200 kV	16
7.3	SUBSTATION CONNECTION ≤ 200 kV	17
8	TRANSMISSION LINE REQUIREMENTS	17
9	SUBSTATION REQUIREMENTS	20
9.1	APPLICABILITY	20
9.2	GENERAL REQUIREMENTS	20
9.3	GROUNDING	20
9.4	INSULATION COORDINATION AND SURGE ARRESTERS	23
9.5	INTERRUPTING DUTY AND SHORT-SURGE PROTECTION	24
9.6	BASIC INSULATION LEVELS (BILs) AND CLEARANCES.....	24
9.7	EQUIPMENT AND MATERIAL SPECIFICATIONS.....	25
9.8	STRUCTURES	32
10	METERING	32
10.1	GENERAL REQUIREMENTS	32
10.2	REVENUE METERING ACCESS, SECURITY, AND TESTING	33
10.3	GENERATION FACILITIES	33



Transmission Facility Interconnection
Requirements

Document #: EU00551257
Revision #: 1
Effective Date: 04/05/2023
Page 4 of 107

10.4 TRANSMISSION FACILITIES.....33
10.5 END-USER FACILITIES.....33
10.6 COMMUNICATIONS34

11 OPERATIONS AND MAINTENANCE 34

11.1 SYNCHRONIZATION OF FACILITIES34
11.2 OPERATIONAL ISSUES (ABNORMAL VOLTAGE, VARs, FREQUENCY, ETC.)34
11.3 COMMUNICATIONS AND PROCEDURES DURING NORMAL AND EMERGENCY OPERATING CONDITIONS35
11.4 MAINTENANCE COORDINATION36
11.5 INSPECTION REQUIREMENTS FOR NEW OR MATERIALLY MODIFIED EXISTING INTERCONNECTIONS36

12 PROTECTION & CONTROL 36

12.1 PHILOSOPHY36
12.2 SPECIFIC REQUIREMENTS COMMON TO BOTH POC AND IPR PROTECTION39
12.3 END-USER REQUIREMENTS56
12.4 GENERATION REQUIREMENTS.....78

13 REVISION HISTORY 95

Attachment A – Telephone Circuit Guidance

Attachment B - Details for PPL EU Control Switch (PCS)

Attachment C – PPL Pre-approved POC/IPR Equipment

Attachment D – Point of Interconnection Diagrams

Attachment E – Interconnection Customer Facilities Review and Acceptance Checklist



1 Purpose and Scope

The purpose of this document is to establish and make available requirements for entities seeking to interconnect to the PPL Electric Utilities (PPL EU) Transmission System. For the purposes of this document, the PPL EU Transmission System includes all PPL EU-owned Transmission Facilities, as defined in Section 1.27 of the PJM Consolidated Transmission Owners Agreement (generally facilities operating at voltages of 69 kV or greater). PPL EU has prepared this document to comply with National Electric Reliability Corporation (NERC) Reliability Standard FAC-001-3 Facility Interconnection Requirements to address interconnection requirements for Generation Facilities, Transmission Facilities, and End-User Facilities.

The requirements in this document apply to new facilities and material modifications of existing facilities interconnected at voltages of 69 kV or greater on the PPL EU Transmission System. All voltage values specified in this document shall be considered as nominal values, unless otherwise stated. Unless otherwise specifically stated, the requirements documented herein apply to all Interconnection Facilities. For PPL EU interconnection requirements for operating voltages lower than 69 kV, refer to the PPL EU website, www.pplelectric.com.

This document applies to all Interconnection Customers (ICs) on the PPL EU Transmission System, except as may be otherwise stated in applicable regulations, tariffs, or agreements. This document does not seek to address any legal, contractual, or liability concerns, nor does it seek to replicate or replace any specific requirements that may be contained in agreements among the interconnected parties. In addition to the requirements in this document, the IC must follow all minimum applicable industry standards. This document may not cover all interconnection scenarios and every request must be reviewed on an individual basis dependent on project specific factors.

The information contained in this document represents minimum design requirements relative to safe and reliable operation of the Transmission System. This shall not relieve the IC from sole and complete responsibility for all aspects of design, installation, and operation of the IC's facilities. Neither PPL EU nor any person acting on behalf of PPL EU makes any warranty with respect to the use of information disclosed in this document or that such use may not infringe on privately-owned rights, or assumes any liabilities with respect to the use of, or for damages resulting from the use of, any information disclosed in this document.

If you have any questions related to contents of this document, please contact the Transmission Interconnection Affairs team at interconnections@pplweb.com.



2 Definitions

Behind the Meter Generation Facilities (BTMG) – Generation Facilities that are on the IC side of POI and behind the revenue meter of End-User Facilities.

End-User Facilities – Interconnection Facilities required to connect end-use (load only) facilities to the PPL EU Transmission System.

Generation Facilities – Interconnection Facilities required to connect generation to the PPL EU Transmission System.

Interconnection Customer (IC) – Any entity interconnected with or interconnecting to the PPL EU Transmission System.

Interconnection Facilities – Any facilities required for an entity to interconnect to the PPL EU Transmission System.

MOLBAB – Motor Operated Load-Break Air-Break Switch operated at 69 kV, installed on a transmission structure.

Point of Contact (POC) – IC-owned device(s) and associated equipment that electrically isolate the IC from the PPL EU-owned Interconnection Facilities or PPL EU Transmission System. There are two main devices that are generally required, a Point of Contact Isolation Device and a Point of Contact Fault Interrupting Device (POC FID).

Point of Contact Isolation Device – A device which provides the physical means to disconnect and provide a visible break between the IC's Substation and the PPL EU-owned Interconnection Facilities or PPL EU Transmission System. These are gang-operated air switches and may or may not provide load break capability.

Point of Contact Fault Interrupting Device (POC FID) – An approved device capable of interrupting normal and fault current which has the primary purpose of isolating an IC from the PPL EU-owned Interconnection Facilities or PPL EU Transmission System. The POC FID is associated with the POC protection package.

Point of Interconnection (POI) – The point or points where the IC-owned Interconnection Facilities connect to the PPL EU-owned Interconnection Facilities or PPL EU Transmission System.

PPL EU Transmission System – The transmission facilities owned, operated, or controlled by PPL EU to control the transfer of energy from one location to another.

Substation – For the purposes of this document, this term can be used to describe a substation (with transformation) or switching station (without transformation) unless specified otherwise.

Transmission Owner – Refer to the NERC Glossary of Terms for definition.

3 Interconnection Procedures

3.1 Procedures for coordinated studies of new or materially modified existing

Within PJM region, PJM administers the new or materially modified interconnection requests of generation and merchant transmission facilities. The PJM interconnection process, as well as related processes for transmission expansion, are described in the PJM Manual 14 series which is available on the PJM website.

PPL EU will coordinate with PJM to perform studies to determine the impact on the affected systems in accordance with NERC, RF, PJM, and PPL EU Transmission Planning Criteria. The PPL EU Transmission Planning Criteria is available on the PJM website or PPL EU can provide to the IC upon request.

Generation and Merchant Transmission Facilities

All interconnection requests for Generation and merchant Transmission Facilities must be submitted by the IC to PJM. PPL EU will coordinate with PJM and the IC pursuant to the process in PJM Manual 14A. PJM Manual 14A describes the new service request process and guides ICs through the application, study, and agreement process. The result of these studies will be the identification of Interconnection Facility scope and other PPL EU Transmission System upgrades required to facilitate the request. Based on the request, PJM will draft the appropriate interconnection service or construction agreement to be executed by all applicable parties.

Existing ICs should also consult their Interconnection Service Agreement or Upgrade Construction Service Agreement when seeking to modify existing Interconnections.

Transmission Facilities (Transmission Owner)

Interconnection requests initiated by another Transmission Owner require a PJM Baseline or Supplemental project. PJM is responsible for the coordination with Transmission Owners of the affected systems. This process is described in PJM Manual 14B. PJM will perform studies as a part of this process to identify impacts on affected systems. These studies and any Transmission Facility upgrades identified are included in the PJM RTEP and made publicly available on the PJM website.

End-User Facilities

Requests for new interconnections or materially modified interconnections for End-User Facilities are governed by the PPL EU General Tariff. Requests must be submitted directly to PPL EU via a completed *Application for New and Change of Three-Phase Secondary/Primary Electric Service and Relocation of PPL Facilities*, which can be made available upon request. PPL EU will evaluate the request to determine the Interconnection Facilities and any PPL EU Transmission System upgrades that may be required to facilitate the new capacity addition. Plans to install new capacity additions, install BTMG, or modify existing interconnection facilities are all considered material modifications for which PPL EU requires a request to be submitted for review. PPL EU will



provide the study results to the IC. If the IC chooses to proceed after receipt of the study results, PPL EU will issue an Electric Service Agreement. If PPL EU Transmission System upgrades have been identified, PPL EU will submit the results to PJM via the RTEP process in PJM Manual 14B.

End-Users seeking to install generation behind their retail meter without access to the PJM wholesale markets must also apply to PPL EU. For more information and to apply for service, please visit our website at pplelectric.com.

3.2 Procedures for notifying those responsible for the reliability of affected system(s) of new or materially modified existing interconnections

Any IC must notify PPL EU of any new facilities or modifications to existing facilities. PPL EU will study the request as necessary.

For End User ICs, PPL EU will determine the notifications necessary to those responsible for the reliability of affected systems. Based on the request, PPL EU will engage PJM to review the request pursuant to PJM Manuals 14A and 14B, which outline the procedures for notifying those responsible for the reliability of affected systems.

3.3 Procedures for confirming with those responsible for the reliability of affected systems of new or materially modified transmission Facilities are within a Balancing Authority Area's metered boundaries

All requests for new Transmission Facilities must go through the RTEP process or the New Services Request process described in PJM Manuals 14A and 14B, respectively. PJM assesses facilities within its Balancing Authority Area's metered boundaries through the process in these Manuals and requirements in its PJM Open Access Transmission Tariff (OATT).

Per PJM Compliance Bulletin CBO28, *NERC Standard FAC-001-3 – Facilities within the metered boundaries of a Balancing Authority*, a PJM issued Interconnection Service Agreement (ISA) or Upgrade Construction Service Agreement (UCSA) is FERC approved evidence that can be used by each IC as confirmation that their new or materially modified facilities are within the PJM Balancing Authority Area's metered boundary.

3.4 Data Required to Properly Study Interconnection

The data required to properly study interconnections for Generation and Merchant Transmission Facilities is outlined in the PJM New Service Request Process in Manual 14A.

For new interconnections or materially modified interconnections for End-User Facilities, the data required is listed on the *Application for New and Change of Three-Phase Secondary/Primary Electric Service and Relocation of PPL Facilities*.

4 Transmission Planning and Evaluation Requirements

4.1 Voltage Level and MW and MVAR Capacity or Demand at the Point of Interconnection

The nominal voltages on the PPL EU Transmission System are 500 kV, 230 kV, 138 kV, and 69 kV. Since voltage and interconnection parameters are site and project specific, PPL EU will analyze each request and perform studies on an individual basis to determine viable voltage and loading levels at the POI. Table 4.1-1 provides the system voltage requirements for the PPL EU system.

Facilities	All Facilities In-Service (%)	One Facility Out of Service (%)
500 kV BES Facilities	100 - 115	97 - 110
230 kV and 138 kV, BES Facilities	95 - 105	92 - 105
69 kV Non-BES Facilities	92.3 – 101.9	89.3 -101.9

Table 4.1-1 – PPL EU Transmission System Voltage Criteria

4.2 Voltage, Reactive Power, and Power Factor Control

The IC shall follow all voltage, reactive power, and power factor control requirements as described in the PJM OATT and agreements as applicable. The power factor shall be measured at the POI.

Generation Facilities

The IC's generating equipment shall not cause excessive voltage excursions and shall operate generating equipment within the voltage or power factor schedule(s) provided by PPL EU. If a voltage schedule is not provided, the IC shall adhere to the ranges specified in Table 4.1-1. The IC shall provide an automatic method of disconnecting its generating equipment from PPL EU facilities to protect against excessive voltage excursions. The IC will install, operate, and service an automatic voltage regulator to maintain the assigned voltage schedule to the extent possible. Steady-state deviation from the voltage schedule of $\pm 0.5\%$ is permissible.

All three-phase generation shall produce balanced 60 Hz voltages. Voltage unbalance attributable to an IC's combined generation and load shall not exceed 1.0% measured at the POI. Voltage unbalance is defined as the maximum phase deviation from average as specified in ANSI C84.1, "American National Standard for Electric Power Systems and Equipment - Voltage Ratings (60 Hz)."

The IC's generator(s) must have the capability of ranging from 0.85 lagging to 0.95 leading power factor. The IC must generate the VAR demand of plant equipment. To maintain security of the power system, PPL EU may request that the IC accept or supply reactive power. For synchronous

generators, the generator voltage-VAR schedule, voltage regulator, and transformer ratio settings will be jointly determined by PPL EU and the IC to ensure proper coordination of voltages and regulator action. For situations where generator voltage or power factor scheduling is inappropriate, adherence to a unity power factor at the POI may be substituted.

Transmission and End-User Facilities

The IC shall operate its equipment in accordance with any applicable power factor requirements as specified in any agreement between PPL EU and the IC.

The NERC Planning Standards state that distribution entities and customers connected directly to the PPL EU Transmission System should plan and design their systems to operate “close to unity power factor” to minimize the reactive power burden on the system. Power factor penalties can be applied based on local jurisdictional terms and conditions.

As necessary, PPL EU will evaluate technical solutions (eg. switched shunt capacitors) for controlling power factor at an IC facility on a case-by-case basis. Factors considered during the evaluation include, but are not limited to, transient voltages and voltage amplification.

4.3 Power Quality Impacts

The PPL EU requirements for maximum allowable harmonic voltage distortion at the POI as a percentage of system voltage are found in Table 4.3-1.

Interconnection Facility Voltage (kV)	Individual Harmonic Distortion (%)	Total Harmonic Distortion (%)
≤ 138	1.0	1.5
> 138	0.7	1.0

Table 4.3.1 – Maximum Allowable Harmonic Voltage Distortion at the POI

If PPL EU discovers that objectionable harmonics in excess of the stated limits are being injected into the system from the IC’s facilities, then the IC will be responsible for taking corrective measures to mitigate harmonic currents.

Concerning voltage flicker, the IC must limit the severity of their voltage variation to within the guidelines set by PPL EU, which uses the General Electric flicker-irritation curves to determine if the system is operating within acceptable limits. A voltage drop of greater than 5% at the POI is generally not acceptable. The frequency and severity of the voltage variation will be considered when determining whether the IC’s facilities are violating PPL EU flicker guidelines. PPL EU will require corrective actions by the IC if their operation causes flickers that exceed PPL EU guidelines.

5 Generation Connection to a Transmission Line

There are two main methods for a Generation Facility to interconnect to a PPL EU Transmission Line: either via a new switching station or a line tap. PPL EU requires a new switching station at a nominal interconnection voltages above 200 kV. PPL EU requires a transmission line tap at nominal interconnection voltages of less than or equal to 200 kV.

The IC is responsible for reserving property for all PPL EU Interconnection Facilities. All properties containing PPL EU substation or switching station facilities must be acquired in fee simple and transferred to PPL EU following all general PPL real estate acquisition requirements. All properties containing PPL EU transmission lines must be acquired in the form of an easement following all PPL Right of Way acquisition requirements. Refer to “PPL Electric Utilities Corporation’s Real Estate, Right of Way Acquisition and Permitting Requirements and Procedures for Independent Power Producers” posted on the PPL EU and PJM websites.

Typical, minimal, simplified station configurations for the PPL EU Facilities are illustrated below. However, final configuration is based on site-specific information and will be determined on a case-by-case basis using reliability considerations.

IC substation requirements are discussed in detail in Section 9 and Appendix A. At a minimum, every Generation Facility is required to have a circuit breaker on the high side of their generator step-up transformer and a utility-lockable disconnect switch.

Additionally, generator lead lines greater than 200 kV must only have two terminals. The generator lead line must not be tapped to create a three terminal line.

5.1 Transmission Line > 200 kV

At nominal interconnection voltages greater than 200 kV, a PPL EU-owned switching station is required. At a minimum, the switching station shall be a two-bay, three-circuit-breaker ring bus, which is expandable into a breaker-and-a-half configuration as depicted in Figure 5.1-1. The IC is responsible for constructing and owning the generator lead line to the Point of Interconnection at the new switching station.

The switching configuration of all circuits terminating at the switching station must provide PPL EU a through-path when the Generation Facility, or associated switching station equipment, is out of service. The configuration of a new switching station will be specific to the project and its location within the PPL EU Transmission System.

The IC is responsible for protection of its facilities. As outlined in Appendix A, PPL EU requires an optical fiber communication cable between the IC’s facilities and the new PPL EU switching station if hardwiring is not practical.

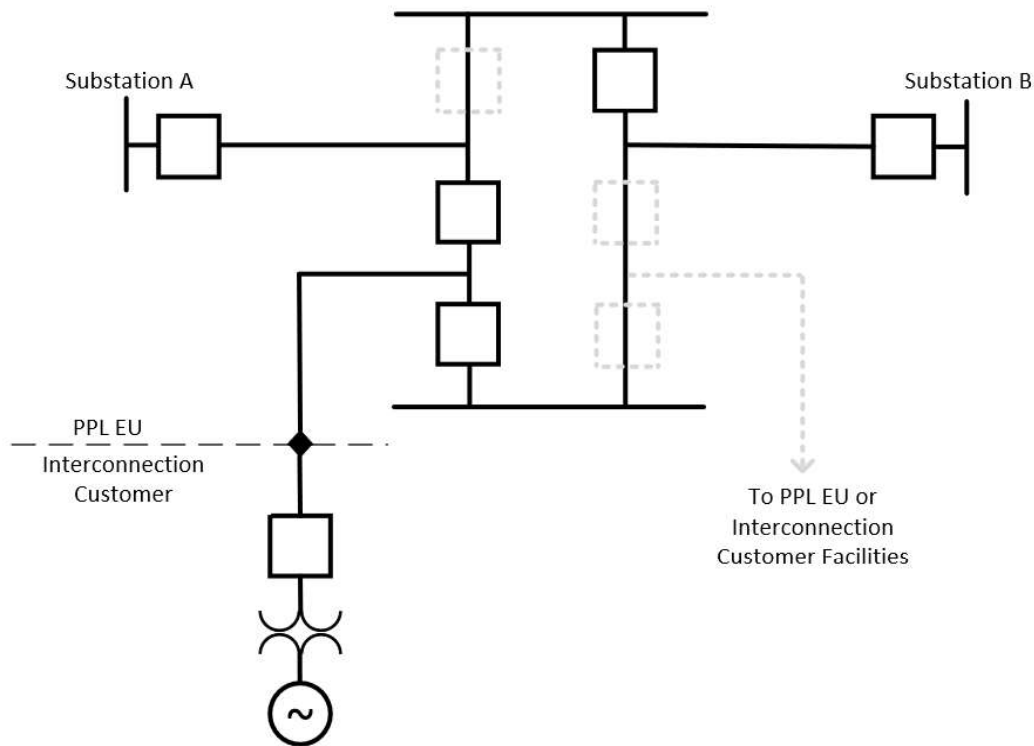

Figure 5.1-1 – Example Substation configuration connected to Generation Facilities

5.2 Transmission Line \leq 200 kV

At nominal interconnection voltages of less than or equal to 200 kV, a line tap with up to three (3) motor-operated switches is required; one (1) on the tap and two (2) on the PPL EU Transmission System (each side of the tap). This will be reviewed at the time the request is received. In general, if the PPL EU-owned interconnection line is operated in network or capable of network operation and the generation may be supplied from more than one PPL EU Substation, the motor-operated switches will be required on the PPL EU Transmission System on each side of the tap. If the PPL EU-owned interconnection line is operated radially and has no alternate sources, then the two interconnection line switches are not required; however those two switches may be scoped into the IC's request to connect to provide additional operational flexibility to the Generation Facilities. For a 69 kV interconnection, the motor-operated switches will be operated by SCADA.

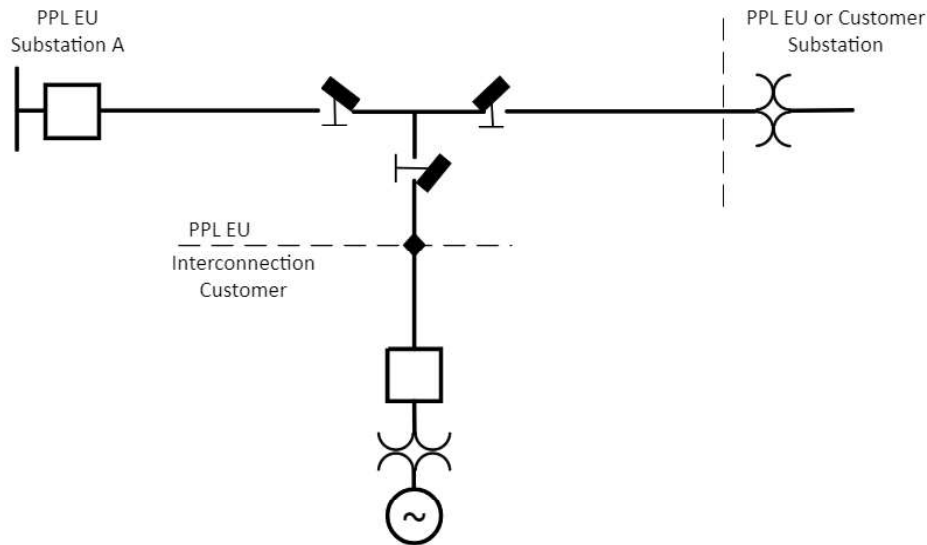

Figure 5.2-1 – Example line tap configuration connected to Generation Facilities

6 End-User Connection to a Transmission Line

There are two main methods for End-User Facilities to interconnect to the PPL EU Transmission System: a new switching station or a line tap. PPL EU requires a new switching station with nominal interconnection voltages above 200 kV. PPL EU requires a transmission line tap at nominal interconnection voltages of less than or equal to 200 kV. The IC may request more than one primary transmission source at the IC's cost. Feasibility of a second primary source is evaluated on a case-by-case basis. Typically, PPL EU will procure the required land and easements required to serve the end-use IC.

In every case, the IC must install a Fault Interrupting Device (FID) and utility-lockable switch on the high side of the IC's step-up transformer. At 200 kV and above, the FID must be a circuit breaker. Between 100 kV and 200 kV, the FID must be a circuit breaker or circuit switcher. Below or equal to 100 kV, the FID may be a circuit breaker, circuit switcher, or a fuse. If the IC installs generation operating in parallel with the PPL EU Transmission System, then the FID must be a circuit breaker regardless of the nominal interconnection voltage. Refer to more details in Sections 8 and 9. The line switches must meet or exceed the thermal capability of the line conductor. The line switches must also be designed to provide appropriate "Line Dropping" or "Loop Interrupting" capabilities.

Typical simplified station configurations are described below.

6.1 Transmission Line > 200 kV

At nominal interconnection voltages greater than 200 kV, a PPL EU-owned switching station is required. At a minimum, the switching station shall be a two-bay, three-circuit-breaker ring bus,

which is expandable into a breaker-and-a-half configuration. PPL EU generally will try to site the switching station as close to the PPL EU Transmission System tie-in point as practical per the applicable procedures and specifications. PPL EU will then deliver electricity via a new transmission line tap to the IC substation.

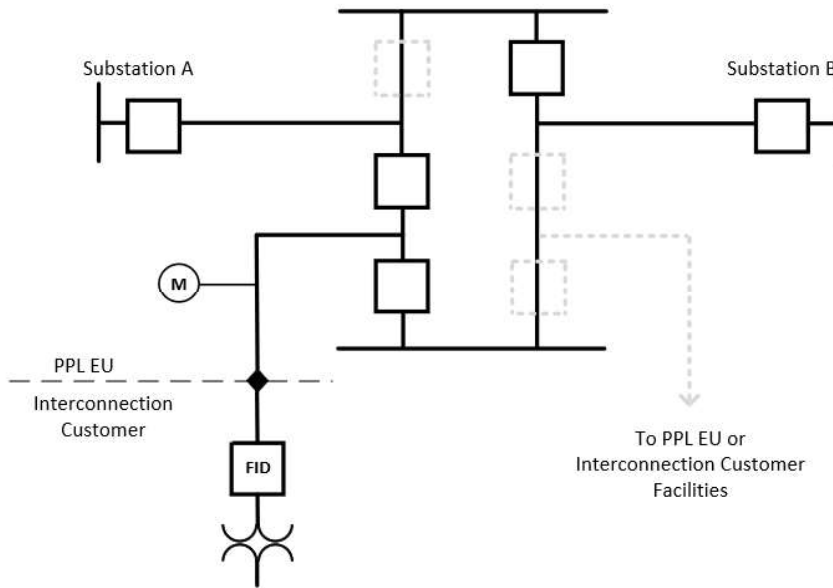

Figure 6.1-1 – Example Substation configuration connected to End-User Facilities

6.2 Transmission Line \leq 200 kV

Single-Line Supply

A radial connection can receive power from only one direction. If the IC's facilities are located near an existing PPL EU transmission line, the connection from the PPL EU Transmission System may be provided by tapping the nearby PPL EU line and constructing a radial line to the IC's facilities. If the POI may be fed from more than one transmission source, an additional MOLBAB on one or both sides of the tap on the existing PPL EU line may be required to enable the POI to be fed from the alternate sources. Scoping of these additional MOLBABs would be optional at the discretion of the IC.

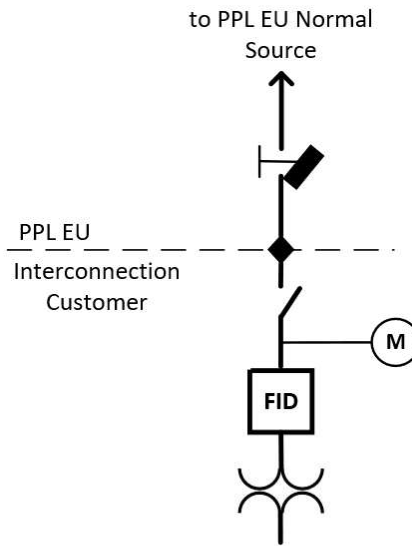

Figure 6.2-1 – Example single-line supply configuration connected to End-User Facilities

Two-Line Supply

A two-line supply can receive power from two (or more) directions. Two-line connections result in fewer and/or shorter outages to the load served at the Point of Interconnection. Figure 6.2-2 represents a typical design where each source is both normal for their respective load and alternate for the other load. For example, source A is normal for load A; however, if there is an issue with PPL EU source A, source B can be the alternate for load A by closing, after proper sectionalizing, the Normally Open (N.O) switch. Therefore, the thermal capabilities of the conductor and switches must be sized for both loads. The line switches must also be designed to provide appropriate "Line Dropping" or "Loop Interrupting" capabilities. Any connections on the low side of the IC's transformers that can provide a through path to the PPL EU Transmission System is prohibited.

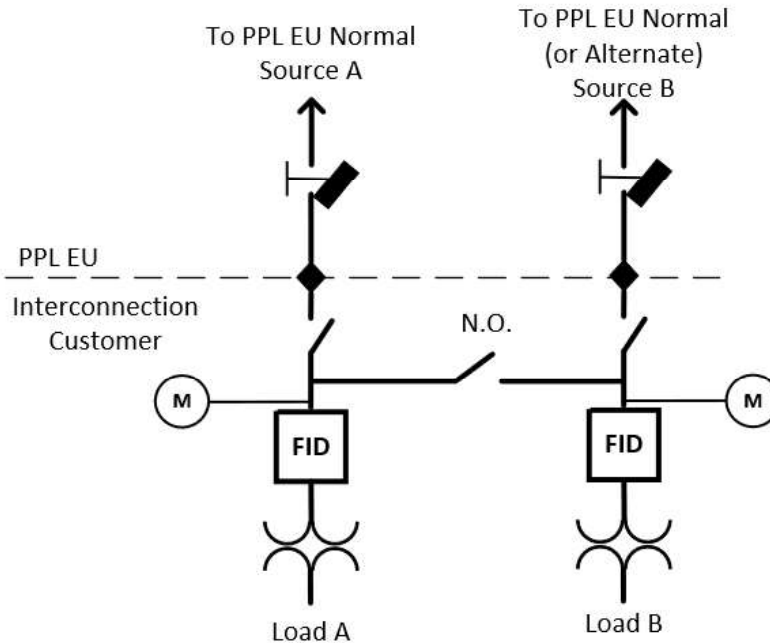

Figure 6.2-2 – Example two-line supply configuration connected to End-User Facilities

7 Connecting to an Existing PPL EU Substation

7.1 Applicability

The same rules apply as described in Sections 5 and 6 for Interconnection Facilities but connecting to a Substation is applicable to both Generation Facilities and End-User Facilities, subject to PPL EU review. Note that in some cases, it may be more practical to tap a transmission line than a Substation.

7.2 Substation Connection > 200 kV

This type of connection is typically into a breaker and a half or a ring bus where the connection point is between two circuit breakers. The switching configuration of all new circuits terminating at the Substation must provide a PPL EU through-path when the Generation Facility or End-User Facility is out of service.

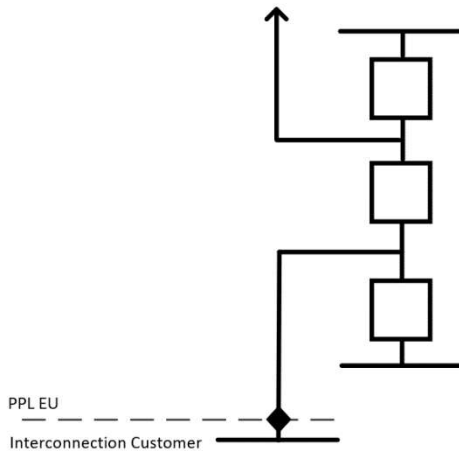

Figure 7.2-1 – Example connection to PPL EU Substation > 200 kV

7.3 Substation Connection ≤ 200 kV

For Generation Facility or End-User Facility interconnections, a straight-bus connection through a circuit breaker is the acceptable minimum. However, due to the importance of the PPL EU Substation, the configuration of the new connection will be specific to the project and its location within the PPL EU Transmission System and may require additional circuit breakers or sectionalizing equipment. This must be reviewed on a case-by-case basis.

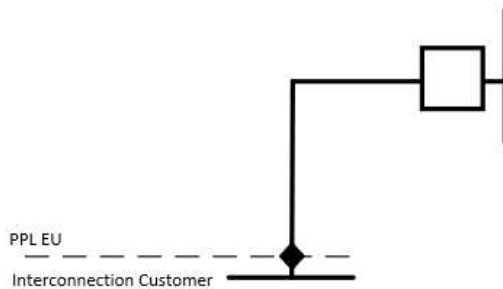

Figure 7.3-1 – Example connection to PPL EU Substation ≤ 200 kV

8 Transmission Line Requirements

The POI between the IC and the PPL EU Transmission System will be site and Facility type dependent. In general, for Generation Facility interconnections the POI is located on the generator lead line at PPL EU's transmission line structure closest to the PPL EU Interconnection switching station or MOLBAB as applicable. For End-User Facility interconnections, the POI shall be the pad on PPL EU's dead-end assembly located on the IC's dead-end structure at the IC substation. Please see Attachment D for examples of typical interconnection ownership configurations.



The IC shall be responsible for designing and constructing its facilities up to the POI.

All PPL EU Transmission Facilities up to and including the POI structure shall be designed per PPL EU Standards and Specifications.

The POI structure (regardless of ownership) will be designed for full terminal loads as well as stringing loads such that temporary construction support (e.g. temporary guying) is not necessary. This structure will be framed per PPL EU Transmission Construction Standards as referenced in Table 8-1. Vangs will be included on the POI structure to which the IC shall attach their dead-end assembly. The IC shall coordinate with PPL EU, supplying point loads for conductors and OHGW/OPGW as applicable. Point loads shall be developed per PPL EU structural design criteria contained in the latest Transmission Engineering Instruction 8-000-001.

Design Voltage	Single Circuit	Double Circuit
69kV	7-007-013	7-007-005
138kV	7-008-013	7-008-005
230kV	7-009-013	7-009-005
500kV	7-010-014	7-010-004

Table 8-1 – PPL EU Structure Framing Standards

Design Voltage	Conductor Factored Load	OPGW/OHGW Factored Load	Design Conductor
69kV	11,550 lb/ph	8,250 lb	795 kcmil 30/19 strand ACSR (Mallard)
138kV	11,550 lb/ph	8,250 lb	795 kcmil 30/19 strand ACSR (Mallard)
230kV	16,500 lb/ph	8,250 lb	1590 kcmil 54/19 strand ACSR (Falcon)
500kV	82,500 lb/ph	16,500 lb	3x 1590 kcmil 54/19 strand ACSR (Falcon)

Table 8-2 – POI Structure Pull-Off Tensions

POI structures may be required to support the pull-off tension values listed in Table 8-2 at a maximum. Exact pull-off tension values can be determined on a case-by-case basis, and will be less than or equal to the values in Table 8-2. All POI structures shall be designed as a full



deadend/terminal structure. Unless otherwise noted, wind span on either side of the structure shall be assumed to be:

- 69 kV: 250 feet
- 138 kV: 250 feet
- 230 kV: 300 feet
- 500 kV: 500 feet

The direction of spans and wires will be determined on a case-by-case basis, but a +/- 1 degree angle buffer shall be applied to all attachment points. For POI deadends located within the IC's substation, all attachment points shall be designed to support a takeoff angle of +/- 15 degrees in all directions.

The electrical clearances in Table 8-3 must be maintained on both sides of the POI structure.

Design Voltage	Ground Clearance (Max Sag)	Minimum Phase-to-Phase Clearance	Minimum Phase-to-OPGW Clearance	Minimum Insulation Requirements
69kV	22.2 feet	12.0 feet	12.0 feet	7 x 52-5 bells per string
138kV	23.6 feet	13.5 feet	13.5 feet	8 x 52-5 bells per string
230kV	25.5 feet	17.0 feet	17.0 feet	13 x 52-8 bells per string
500kV	31.4 feet	32.0 feet	26.5 feet	26 x 52-11 bells per string

Table 8-3 – POI Structure Electrical Clearances

The electrical connection between PPL EU's facilities and IC's facilities shall be a jumper loop. The IC's dead-end assembly shall provide a 4-bolt NEMA pad to make the jumper loop connection. PPL EU will select and provide a conductor for the jumper loops based upon the IC's stated ampacity requirements.

IC's overhead ground wire (OHGW) and/or optical ground wire (OPGW) shall be bonded to the POI structure. A ½ inch stainless steel nut welded to the pole face will be provided on the structure by the pole manufacturer for bonding connection.

If fiber interconnection is required, PPL EU will supply a fiber splice enclosure at the POI structure. The IC is responsible for providing fiber exiting the fiber splice enclosure. Fiber shall be attached to the structure with downlead clamps. Downlead clamps may be attached using stainless steel banding, powder driven fasteners (HILTI™), or two 5/8 inch stainless steel nuts. For details on the

fiber attachment, refer to Transmission Construction Standards 7-005-050 and 7-005-160. All fiber splicing shall be performed by PPL EU.

9 Substation Requirements

9.1 Applicability

The requirements in this section are applicable to any IC-owned substation connecting to the PPL EU Transmission System. PPL EU does not construct, own, or operate substations whose purpose is to transform voltage between the PPL EU Transmission System and the IC. PPL EU has additional requirements and standards for substation facilities to be owned and operated by PPL EU not contained within this document. These will be made available on an as-needed basis.

9.2 General Requirements

The IC must have PPL EU review and concur with the design details related to equipment and materials that have the potential to impact the PPL EU Transmission System or the Point of Contact (POC) device(s)/structure(s) as specified herein **before** placing orders for any such equipment or materials.

PPL EU reserves the right to require further design requirements or substation orientation changes to best accommodate the transmission termination if unique features or conditions exist in the IC's proposed facility.

All substation facilities to be owned and operated by PPL EU must be built to PPL EU internal standards and specifications.

The location and orientation of the IC substation must be coordinated with the PPL EU transmission line requirements in Section 8.

See Sections 5, 6, and 7 for general guidance on what PPL EU Interconnection Facilities are required based on the specifics of the request.

9.3 Grounding

9.3.1 General Requirements

Any work carried out within an Interconnection Facility shall be performed in accordance with all applicable laws, rules, and regulations and in compliance with Occupational Safety and Health Administration (OSHA) and NESC. Only trained operators are to perform switching functions within an Interconnection Facility under the direction of the responsible dispatcher or designated person as outlined in the NESC. The IC and PPL EU must agree to switching and permit and tag (i.e., lock out/tag out) procedures that will be adhered to for the safety of all personnel and the public.

The IC's outdoor substation facilities must have an adequate grounding system to ensure step, touch, and transferred voltages are limited to safe thresholds. Accordingly, each electrical facility must have a grounding system or grid that solidly grounds all metallic structures and equipment in accordance with standards outlined in the latest revision of IEEE 80, IEEE Guide for Safety in AC Substation Grounding, and IEEE C2, National Electrical Safety Code (NESC) and include the following:

- Substation shall have a perimeter ground ring approximately 3 feet outside the fence line.
- The perimeter ground ring shall be designed to accommodate the swing of the entrance gate.
- All gate entrances, man and vehicular, shall have their stationary posts bonded to each other and to the swing panels. Stationary post bonding by connections to the perimeter ground ring is acceptable.
- All air-switch operating mechanisms shall be bonded to the substation structure by a suitable flexible braid connection from the operating pipe (near the operating mechanism) to the structure. A connection shall be made from the structure (near the operating mechanism) to the ground grid.
- Each switch operating mechanism shall also have an above-grade steel platform/grating bonded to both the operating pipe and the ground grid.
- Copper-clad steel conductors are strongly encouraged as above-grade grounds to reduce the risk of outages associated with copper theft.
- Substation yard surfacing (6-inch layer of crushed stone or macadam) should extend 10 feet beyond the substation fence line along all sides.
- Calculations shall consider step, touch, and transferred voltages with respect to an individual weighing 50 kg.
- The IC is not permitted to directly connect or tie to a PPL EU Substation ground grid.
- A minimum 15-foot buffer shall be provided between PPL EU Substation and IC substation fences.

In conjunction with IEEE 80, Annex C methodology, equivalent impedance formulas shall be used based on the tower footing resistance of each connected transmission line. On the PPL EU system, 500 kV transmission lines are built with 15 Ω average resistance and 69 – 230 kV transmission lines are built with 25 Ω average resistance. The associated exit path equivalent impedances for those voltage classes are specified below. If the IC builds a transmission line up to the POI outside the Substation fence, the IC shall verify the tower footing impedance of the line(s) to determine the appropriate equivalent impedance to utilize for the exit path(s).

For 500 kV lines, $ZT = 2.64 + j0.60$ per exit path

For 69-230 kV lines, $ZT = 3.35 + j0.75$ per exit path

9.3.2 Soil Resistivity

Soil resistivity tests shall be made in accordance with the “Four-point Method” and “Fall of Potential Method” as outlined in the latest revision of IEEE 81, “Guide for Measuring Earth Resistivity, Ground Impedance, and Earth Surface Potentials of a Grounding System”.

Soil resistivity measurements prior to site construction allow for accurate design of the grid. Measurements after construction and prior to energization allow for confirmation and/or modification to design given as-built site conditions to ensure tolerable step, touch, and transferred voltages.

9.3.3 Ground Grid Testing

The IC shall have the substation grounding system tested for soil resistivity and the impedance to remote earth prior to making a connection to any PPL EU line and energizing the Interconnection Facilities. The IC is responsible for arranging the test(s) and costs associated with such work.

All tests shall be conducted before any PPL EU shield wires, counterpoises, and/or system neutrals are connected to the Interconnection Facility. If any external neutrals are connected before conducting ground testing, the results will yield false, lower-value readings. Neutral(s) of any temporary construction power services must be properly isolated from the substation grounding system before tests are made. The test circuit configuration shall be so arranged that no “sneak circuits”(e.g. unintended electrical paths within the circuit and its external interfaces) exist through the measurements.

All ground resistance test results must be submitted to PPL EU for approval and must include:

- Geometry of the test circuit showing relative positions/directions and distances between test and reference electrodes. An accurate sketch or field-marked location plan drawing is acceptable.
- Actual resistance measurements at several reference points including the “theoretical 62% point.” Measurements shall be submitted as tabled values and graphically to illustrate the “plateau” and inflection points in the resistance curve. PPL EU prefers the effective resistance to remote earth of the IC’s substation ground grid to be five (5) ohms or less; however, higher ground resistance is permissible provided step, touch, and transferred voltages are below safe thresholds. Ground grid values of less than 5 ohms do not necessarily guarantee a safe design, and this is provided as a general reference value only; the measured resistance values must be checked by the IC’s engineering representative against the ground grid design to confirm that step, touch, and transferred voltages are below safe thresholds per IEEE 80.

9.3.4 Effectively Grounded System

When various switching devices are opened on an energized circuit, its ground reference may be lost if all sources are not effectively grounded. This situation may cause over voltages that can affect personnel safety and damage equipment. This is especially true when one phase becomes short-circuited to ground. Therefore, the Interconnection Facilities are to be, at a minimum, effectively grounded from all sources as outlined in the latest revision of IEEE C62.92.1.

Interconnected generators should provide for effective system grounding of the high-side transmission equipment by means of a grounded high-voltage generation step-up transformer.

9.4 Insulation Coordination and Surge Arresters

Insulation coordination must be designed properly both for personnel safety and to protect the electrical equipment from over-voltages resulting from faults, lightning or switching surges, ferroresonance, etc. An insulation design must:

- Electrically isolate energized parts from supporting structures or ground when voltage stresses are applied.
- Mechanically support energized parts during normal and fault conditions.

Surge arresters are used to reduce voltage stresses on equipment. Gapless, metal-oxide varistor (MOV) arresters shall be installed and adhere to the latest revision of IEEE C62.22. PPL EU 69 kV and 138 kV systems may operate temporarily as an ungrounded system for up to 2 seconds during abnormal system conditions. The maximum 60-hertz voltage for determining the minimum arrester rating occurs during a temporary, ungrounded operation with concurrent single line-to-ground fault. The minimum surge arrester ratings are listed in Table 9.4-1.

Nominal System Voltage (kV)	Duty-cycle voltage (kV rms)	Maximum Continuous Operating Voltage (kV rms)	Energy Class	Arrester Class
69	72	57	C	Station
138	132	106	B	Station
230	180	144	E	Station
500	396	318	J	Station

Table 9.4-1 – Minimum Surge Arrester Ratings

Interconnection Facilities to be constructed in areas subject to contamination shall be designed with the appropriate leakage distance based on the pollution level as defined in IEEE 1313.2-1999.

Surge arresters must be connected to the **Interconnection Customer side** of the Point of Contact (POC) Fault Interrupting Device (FID). Location and quantity are to be determined by IC's engineering representative. Other locations must be reviewed with PPL EU for concurrence. PPL EU strongly discourages connecting surge arresters to the line side of the POC FID. However, if conditions require a line-side connection, the customer must use a self-disconnecting type of arrester.

9.5 Interrupting Duty and Short-Surge Protection

Substation equipment shall have interrupting and momentary ratings adequate for the normal and short circuit conditions provided. Fault Interrupting Devices (FID) shall have the open-close duty cycle ratings necessary to accommodate their required open-close sequences. Interrupting devices shall be designed and tested in accordance with the applicable standard(s) of the IEEE C37 group of standards.

9.6 Basic Insulation Levels (BILs) and Clearances

Minimum insulation levels for service voltage (higher levels are IC's option):

69 kV system = 350 kV BIL
138 kV system = 650 kV BIL
230 kV system = 900 kV BIL
500 kV system = 1550 kV BIL, 1050 kV BSL

Electrical clearances (phase-to-phase, phase-to-ground, elevation above grade/road, etc.) of bus conductor and equipment in a substation shall, at a minimum, be designed to the National Electrical Safety Code (NESC) and National Electrical Code (NEC) requirements, latest code revisions, for the BIL and/or BSL insulation levels chosen.

BSL is applicable at 345kV and above in accordance with the PJM design criteria and current manufacturer specifications for equipment. A maximum switching surge of 2.34 p.u. is assumed for clearances at 500 kV and is equivalent to the 1050 kV BSL specified in IEEE 1427. At voltage levels 230 kV and below, BIL will govern the required clearances.

Minimum phase-to-phase (centerline) spacing of POC air switches and tie air switch (if installed) are detailed in Table 9.6-1 below.

Nominal System Voltage	Basic Impulse Level	Vertical Break Disconnecting Switches	Side Break (Horizontal Break) Disconnecting Switches	All Horn-Gap Switches Including POC Isolation Devices* (Vertical and Side Break)
(kV)	(kV BIL)	(inch)	(inch)	(inch)
69	350	60	72	84
138	650	96	132	144
230	900	132	192	192
500	1550	300**	300**	300

* This category includes any switch having attachments which perform open-air arc extinction. All POC Isolation Devices (air switches) are horn-gap switches because they are required to be provided with arcing horns and therefore the phase-to-phase spacing in this column applies.

** These values not yet established by IEEE C37.30.1-2011.

Table 9.6-1 – Minimum phase-to-phase (centerline) spacing of air switches

9.7 Equipment and Material Specifications

9.7.1 Power Transformers

General

The IC **must contact PPL EU prior to ordering or specifying** the main power transformer. Depending on the size, location on the PPL EU system, and other concerns, an alternate winding configuration may be specified.

Refer to the voltage phase relations diagram posted on the PJM Planning website. Under the Planning, Engineering, & Construction section, select Transmission Owner Guidelines and then Annex A. The PPL EU system phasing diagrams are listed as P P & L Inc.

<https://pjm.com/-/media/planning/design-engineering/maac-standards/annexa.ashx?la=en>

For 500 kV, PPL EU employs an “A-B-C” phase sequence (rotation). For voltage levels of 230 kV and below, PPL EU employs a “C-B-A” phase sequence (rotation).

PPL EU connects the high side of its delta-wye power transformers in the following manner in all regions except the Lancaster region:

C phase – H3 Bushing
B phase – H2 Bushing
A phase – H1 Bushing

For the Lancaster region:

C phase – H1 Bushing
B phase – H2 Bushing
A phase – H3 Bushing

For all PPL EU regions except Lancaster, the transformer connections noted above and the standard phase relationships and transformer terminal designations for three-phase power transformers as outlined in IEEE Standard C57.12.00-2015 result in a non-standard phase displacement of the low side voltage leading the high side voltage by 30 degrees. For Lancaster region, the transformer connections noted above and the standard phase relationships and transformer terminal designations for three-phase power transformers as outlined in IEEE Standard C57.12.00-2015 result in a standard phase displacement of the low side voltage lagging the high side voltage by 30 degrees.

Generation Facilities or BTMG

The IC's power transformers at > 30 kV nominal high voltage values (i.e. interconnection voltage) must have wye-connected, grounded high-side windings, with neutral insulation suitable for impedance grounding and delta-connected low-side windings. All three-phase generation must be isolated from PPL EU customers by a power transformer. This requirement also applies for customers with distributed generation/parallel generation capability (make-before-break switching).

End-User Facilities

The IC's power transformer(s) connected to PPL EU system at > 30 kV and \leq 200 kV nominal high voltage values (i.e. interconnection voltage) must have delta-connected high-side windings and wye-connected, grounded low-side windings, with neutral insulation suitable for impedance grounding. If connecting at > 200 kV, the power transformers must have wye-connected, grounded high-side windings, with neutral insulation suitable for impedance grounding and delta-connected low-side windings. If connecting at > 200 kV and the power transformers will have connected tertiary windings, the power transformers must have wye-connected, grounded high-side windings, with neutral insulation suitable for impedance grounding, wye-connected, grounded low-side windings, with neutral insulation suitable for impedance grounding, and delta-connected tertiary windings. Refer to Table 9.7-1 below for a summary of transformer

winding connections. These requirements are for ICs with load or load with emergency standby generation (break-before-make switching).

Existing End-User Facilities connected at ≤ 200 kV who are also connecting generation, may be required to install additional protection equipment due to the high-side delta connection of the existing transformer.

The PPL EU representative **shall be contacted** to provide transformer tap recommendations **prior to purchase** and to provide a desired tap setting at the specific location given the IC’s load characteristics. For an example, PPL EU normally buys transformers for 69 kV use specified as 67-13.2 kV, with 5 step positions – two 2.6 % taps above and two 2.6% taps below the transformer high voltage midpoint of 67 kV for a range of 70.6 kV to 63.40 kV; transformers for 138 kV use are specified as 138-12 kV, with 5 step positions – with two 2.5% taps above and two 2.5% taps below the transformer high voltage midpoint of 138 kV for a range of 144.9 kV to 131.1 kV. A manually-operated de-energized tap changer (DETC) should be furnished for changing taps with provisions for positively locking the tap changer in any tap position with a standard padlock. Since the tap changer is not expected to be regularly exercised, the DETC should coordinate with the transformer’s thermal overload capability and should also be oversized to ensure that the contacts will not overheat and lead to coking or gassing during normal operation.









Interconnection Type	Interconnection Voltage	High Side (PPL EU system interface side)	Low Side	Tertiary
End User	> 30 kV & ≤ 200 kV			
End User	> 200 kV	 	 	
IPP Generation	> 30 kV			

Table 9.7-1 – Transformer Winding Connections for Interconnection to PPL Transmission System

9.7.2 Operating Transformers

All substation loads, such as battery chargers, lights, heaters, etc., will be supplied from operating transformers. These operating transformers must be connected such that the billing metering will record the usage of the load connected to them. The sole exception to this policy occurs if the operating transformers are connected to the IC's load side of a Fault Interrupting Device (FID), which requires AC voltage for its control circuits. In this case, a separate operating transformer with a maximum rating of 1.5 kVA may be connected to the supply side of the FID and is permitted for FID control only. No other station load is permitted to be connected to this operating transformer.

9.7.3 POC Isolation Devices

Air Switches are used exclusively as the POC isolation device between an IC and PPL EU.

In all situations, the equipment must have short-time withstand and peak withstand ratings in accordance with IEEE C37.30.1 based on the designed continuous current rating.

Those switches that are used in a Two-Line Supply configuration (Normal/Alternate or Load-Split) as described in Section 6.2, must have the capability to interrupt parallel loop current flow between the two PPL EU sources when the IC's load is transferred between sources without a service interruption (by authority of PPL EU System Operator). These switches must be mechanically interlocked (electrically if motor-operated) to prevent unauthorized paralleling of the PPL EU source lines. The interlock system (KI) shall contain an interlock "cheater" key (tamper-proof interlock bypass switch if electrical) for controlled switching by PPL EU personnel **only**. They must also be capable of being secured and padlocked in the open position.

Provide the physical means to disconnect, and provide a visible break, between the IC-owned substation and the PPL EU Transmission System. Specific requirements by voltage class are as follows:

- 69 kV or 138 kV; three-pole, gang-operated, with horn gap (arcing horn); manual swing handle, worm gear drive, or motor-operated mechanism
- 230 kV (three-pole) or 500 kV (single-pole), gang-operated with horn gap (arcing horn); motor-operated mechanism

Interrupter accessories shall be installed on the POC switches as appropriate for the installation. These include, but are not limited to:

- Interrupter attachment (with whip interrupter) for loop sectionalizing, line (bus) de-energizing, and transformer magnetizing current-switching applications.
- Interrupter attachment (without whip interrupter) for loop sectionalizing (parallel-switching) applications.

9.7.4 Visible-Break Safety Switch (or Visible Breaker Disconnect Switch)

For Generation Facilities or BTMG, a visible-break safety switch or visible breaker disconnect switch is required to be installed **except a single-phase certified inverter-based installation of 10 kVA or less**. For Generation Facilities and BTMG interconnections, the POC circuit isolation device may serve as the visible-break safety switch provided it meets the additional criteria specified below.

The visible-break safety switch (or visible breaker disconnect switch), when in the open position, allows the physical contacts to be viewed and provides electrical isolation of the generator from the PPL EU system. This device is an important safety item and **must** be reviewed by PPL EU for correct application, correct position, and correct type, **prior to the start of construction**. A warning sign must be placed to warn that both sides of the visible-break safety switch may be energized in both the open and closed positions.

Devices employed to meet this requirement must comply with IEEE 1547. Devices designated for use as 'visible-break disconnect,' fused disconnect switches, and circuit breakers that can be physically removed or 'racked out' from switchgear and locked on the removed/racked-out position are all acceptable devices. Non-acceptable devices include:

- Load-break switches with arc chutes that obscure a direct view of the contacts with the switch in the open position
- Molded case circuit breakers
- Any device with hidden or non-observable contacts

If the IC facility requires load-break capability, then a second device must be installed in series with the visible-break safety switch to provide the load breaking capability.

Contact PPL EU for the latest specification, possible switch locations, and types of switches available.

9.7.5 Point of Contact Fault Interrupting Devices (POC FID)

In all situations, FIDs must be capable of interrupting the maximum expected fault duties expected at the Interconnection Facility, which may be different from the actual present data. While PPL EU will endeavor, where possible, to anticipate future system changes which may affect the provided values, it does not assume responsibility or liability with respect to such protective devices, nor guarantee their continuing adequacy against increased interrupting capacity requirements resulting from system changes. The IC is responsible for periodic review of existing and future fault conditions and for any future equipment upgrades/replacements that are required.

The following devices are approved for primary protection in Interconnection Facilities:

Fuse Switch

69 kV, Type SMD-2B (approved supplier: S&C), single pole, disconnecting-type power fuse with holder capable of hook-stick operation. The minimum requirements for the fuse switch are 69 kV, 350 kV BIL, 300 amperes maximum continuous rating, and 2,000 MVA minimum interrupting rating; the final ampere size and fuse characteristics are to be determined by PPL EU. Fuse switches are only permitted as FIDs at 69 kV and between PPL EU and End-User Facilities only.

Circuit Switcher

69 kV or 138 kV, three-pole, with continuous, momentary, and interrupting ratings in accordance with requirements of the Ratings Section 9.7.8 below. Circuit switchers are permitted as FIDs between PPL EU and End-User Facilities only.

Power Circuit Breaker

69 kV, 138 kV, 230 kV, or 500 kV, vacuum or SF6 insulating medium, single or three-tank style. Interrupting rating to be determined based on PPL EU criteria for the particular proposed installation. Please contact PPL EU for detailed information.

9.7.6 Other Switches

Grounding Switches

Manually operated, shall be supplied at 500 kV on each side of circuit breakers and at each line entrance.

Tie Switches

As used in a Two-Line Supply configuration with load split between two sources, a tie-switch must be a three-phase, gang-operated air break switch similar to the Point-of-Contact switch in Section 9.7.3. It must be interlocked with the Point-of-Contact switch(es). It must also have parallel loop current interrupting capability (necessary only if total plant load cannot be supplied by one power transformer on a continuous basis).

9.7.7 Surge Arrester

In all situations, such equipment must comply with PPL EU Insulator coordination and Surge Arrester protection requirements.

Surge arresters must be connected to the Interconnection Customer side of the POC FID. Location and quantity are to be determined by IC's engineering representative. Other locations must be reviewed with PPL EU Engineering for concurrence.

PPL EU strongly discourages connecting surge arrestors to the line side of the POC FID. However, if conditions require this type of connection, the IC must use a self-disconnecting type of arrestor.

Note that PPL EU transmission lines may be terminated with a surge arrestor.

9.7.8 Ratings

All interconnecting station equipment specifically listed within this document shall have interrupting, peak current, and continuous ratings no less than those in Table 9.7-2. The bus, connections, and ground grid shall withstand the symmetrical short circuit current for 2 seconds. Structure and equipment connections to the ground grid shall withstand the symmetrical short circuit current for 0.5 seconds. Bus work, connections and connected equipment, ground grid and connections, and portable grounds, shall withstand the peak current (as defined in IEEE C37.04, IEEE C37.06, and IEEE C37.100) with a duration of 0.167 seconds and all forces and movement associated with the peak current, without damage or resulting in electrical clearances below “temporary closeness”.

System Voltage (kV)	Symmetrical short circuit rating (kA)	Peak current rating (kA)	Continuous
500	50	130	4000
230	50	130	2000
138	40	104	2000
69	31.5**	82**	2000**

*Table is of minimum values; higher ratings may be required.

**Gang-operated switches and breakers

Table 9.7-2 – Minimum Short Circuit (Interrupting), Peak, and Continuous Current Ratings*

9.7.9 Legacy Equipment

In general, if any equipment identified within the Transmission Facility Interconnection Requirements is required to be replaced as a result of upgrades or changes to the IC’s facilities, then the latest standards or requirements identified herein are expected to be followed. Likewise, when replacing equipment that is at its end-of-life, for maintenance purposes, or for failed equipment, the preference is to upgrade to equipment that meets the most current standards and requirements.

In certain circumstances (i.e. emergency replacements), equipment may be replaced with like-in-kind equipment, so long as it is technically capable of performing all required functions and meets all critical characteristics as the originally installed equipment. PPL reserves the right to require this equipment to be upgraded to the most current standards and requirements at the time of replacement if it is determined that the replacement equipment will have any operational impacts on PPL equipment or to any other ICs.

9.8 Structures

All IC structures that are associated with the POC or POI within a substation shall be designed and fabricated in accordance with the ASCE "Guide for Design of Substation Structures." All Steel Structures shall have a galvanized finish in accordance with ASTM A123.

Dead-end structures located in an IC's substation shall be designed per the POI Structure requirements in Section 8.

All Steel Structures shall have a galvanized finish in accordance with ASTM A123. PPL EU does not recommend the use of any wood structures for substations.

10 Metering

This section covers meters and metering equipment installed for the purposes of energy and revenue accounting. In all cases, PPL EU shall approve all revenue metering and metering equipment installed by an IC. The revenue metering equipment may be installed, owned, and operated by either PPL EU or the IC as specified in applicable tariffs or agreements. Revenue metering equipment includes, but is not limited to, meters, current transformers (CTs), potential transformers (PTs), meter sockets, structures, wiring, test switches, communication channels, etc.

10.1 General Requirements

At a minimum, revenue metering equipment shall meet all PPL EU Tariff Requirements and meet or exceed all applicable industry standards such as ANSI, IEEE, NEMA, and REMSI. If the IC is participating in the PJM wholesale market, then the IC must abide by rules and procedures in PJM's Manual 14 Series, and applicable sections of the OATT.

The revenue meters shall be capable of recording, storing, and transmitting bidirectional kilowatt-hour (kWh) and kilovar-hour (kVARh) data.

The revenue meters shall be connected to dedicated CTs and PTs and should not share the same circuit with meters and other devices. In cases where a PT with multiple secondary windings is installed, one of the windings must be dedicated exclusively to revenue metering function and this winding is not permitted to be used for IPR or POC relaying functions or any other functions deemed necessary by the IC; all other requirements of Section 10.2 shall apply to these cases as well including physical access and accuracy requirements.

PPL EU requires all metering equipment to be installed inside a dedicated cabinet with a latching door suitable for a PPL EU locking device.

In general, when the revenue metering is located at IC Facilities, it shall be located between the IC's main transformer and their fault interrupting device. The IC's proposed metering location and installation design must be approved by PPL EU.

10.2 Revenue Metering Access, Security, And Testing

At IC facilities where PPL EU specified, furnished, and/or owns revenue metering equipment, the IC shall grant PPL EU employees and authorized agents access during reasonable hours and for reasonable purposes. The IC shall not permit unauthorized individuals to have access to the revenue metering equipment. All metering equipment shall be installed inside a dedicated cabinet with a latching door suitable for a PPL EU locking device.

Revenue metering shall be tested for accuracy as specified by applicable tariffs, regulations, PJM requirements, and agreements.

10.3 Generation Facilities

All Generation Facilities must have revenue metering and must abide by PJM metering requirements. In general, the revenue metering should be located at the IC facilities regardless of ownership. If the Generation Facilities are interconnecting to a PPL EU Substation and PPL EU owns the metering, then the metering should be located at the PPL EU Substation. If the metering location is not at the POI, the revenue meters shall be compensated for losses between the meter location and the POI.

Note that revenue metering for BTMG is covered in Section 10.5 below.

10.4 Transmission Facilities

For a new interconnection with another Transmission Owner, the requesting IC shall install, own, operate, test, and maintain the revenue metering equipment unless otherwise agreed to by PPL EU and the IC. The revenue metering equipment shall be installed at the POI or compensated for losses between the meter location and the POI.

10.5 End-User Facilities

Revenue metering is required for all End-User Facilities. In general, PPL EU shall own, operate, and maintain the revenue metering. The metering shall be located at the End-User's Facilities.

End-User Facilities with BTMG may require additional revenue metering. BTMG can be complex and therefore will be reviewed on a case-by-case basis. Per Section 10.3 above, PPL EU will own, operate, and maintain the metering for BTMG in a manner consistent with revenue metering for the End-User Facilities.

10.6 Communications

The IC shall install, own, operate, test, and maintain any communications equipment required by PPL EU to remotely retrieve revenue metering data from the IC facilities. The communication equipment shall be compatible with PPL EU for remote retrieval and interrogation.

If PPL EU owns the revenue metering, PPL EU will provide the IC access to the bidirectional kWh and kVARh pulses to the IC. The pulses will be provided upon request. Alternatively, this data may be provided to the IC via DNP, MODBUS, or other protocol.

11 Operations and Maintenance

11.1 Synchronization of Facilities

Every Generation IC interconnected with and synchronized to the PPL EU Transmission System must always coordinate operation with the PPL EU Transmission System Operator (TSO), providing all necessary and requested information and equipment status, to assure that the electrical system can be operated in a safe and reliable manner. This coordination includes, but is not limited to:

- Supplying the generator net-MW and MVAR output.
- Communicating to the PPL EU TSO any change(s) to the generator AVR status.
- Supplying frequency and voltage levels.
- Scheduling the operation and outages of facilities including providing advanced notification.
- Coordinating the synchronization and disconnection of the unit.
- Providing data required to operate the system and to conduct system studies.
- Providing documented start-up and shutdown procedures including ramp-up and ramp-down times.
- Following operation during emergency and restoration conditions.
- Following operation during transmission-constrained conditions.

11.2 Operational Issues (Abnormal Voltage, VARs, Frequency, etc.)

Each Generation IC shall have and follow a voltage schedule provided to them by PPL EU or PJM default voltage schedule as per PJM Manual M-3, Transmission Operations. Conditions may be encountered on the PPL EU Transmission System that require participation in remedial action. These conditions include, but are not limited to, actual or contingency flow or voltage-limit violations, violation of synchronous stability limits, low or high frequency, voltage reductions, system blackouts, and maximum and minimum generation conditions. During an emergency (as

determined/declared by PPL EU or by PJM) the Generation IC shall respond as promptly as possible to all directives from the TSO. These directives may relate to actual or contingency thermal overload of electrical circuits or actual or contingency high/low voltage conditions. PPL EU may also direct the Generation IC to:

- Increase or decrease the facility energy and/or reactive output,
- Connect or disconnect the facility from the PPL EU Transmission System, and/or
- Deviate from the prescribed voltage or reactive schedules.

If safety or system reliability conditions warrant, PPL EU may isolate the facility from the PPL EU Transmission System without prior notice to the Generation IC or upon such notice as is possible under the circumstances. The TSO shall advise the Generation IC as soon as possible of any forced outages of the PPL EU Transmission System that affect the facility's operations. The Generation IC shall maintain communications and contact with the TSO during all emergency operations. When PPL EU, or PJM, has determined that the emergency conditions have been alleviated, PPL EU shall inform the Generation IC and allow the facility to return to normal operations. To safely restore the PPL EU Transmission System following the outage of any facility, the facility isolated from the PPL EU Transmission System shall be allowed to reconnect only under the direction of the TSO. In all cases, the facility shall be made ready to return to service and provide energy to the PPL EU Transmission System as soon as possible.

11.3 Communications and Procedures During Normal and Emergency Operating Conditions

Telecommunications (voice and data) circuits, which must be reliable and secure, should be tested regularly and/or monitored online, with special attention given to emergency channels.

For emergency conditions and operational issues/outages during non-core business hours:

- The TSO will advise the Generation IC of any alarms on the Interconnection Facilities. If the Generation IC is unable to resolve any alarm on the IC's side of the POI, the TSO may advise of a proposed call out of PPL EU personnel.

For non-emergency conditions, the communications should be coordinated with the Key Account Manager (KAM) or the Business Accounts Department via this [link](#) or email at businessaccounts@pplweb.com. Examples include:

- The IC needs PPL EU to interrupt service to perform maintenance work.
- The IC needs to obtain information on non-emergency operational issues or outages during core business hours.
- The IC needs to initiate a request for a planned outage.
- The IC requests PPL EU to perform work on Interconnection Facilities or PPL EU facilities to support Generation IC equipment modifications.

- The KAM will advise the Generation IC of new, or updated, applicable operating instructions.

11.4 Maintenance Coordination

PPL EU and the IC should coordinate the planning and scheduling of preventative and corrective maintenance to the IC's facilities, Interconnection Facilities, or the PPL EU Transmission System.

The IC should review applicable interconnection agreements for specifics on the coordination of maintenance activities. In general, each interconnected party should maintain, or initiate the maintenance of, its facilities in a safe and reliable manner in accordance with all applicable standards, rules, procedures, protocols, all applicable laws and regulations, and good utility practice.

11.5 Inspection Requirements for New or Materially Modified Existing Interconnections

The IC should review applicable interconnection agreements for specifics on required inspection activities. PPL EU and the IC should perform inspections and testing of their respective facilities in accordance with all applicable standards, rules, procedures, protocols, all applicable laws and regulations, and good utility practice.

PPL EU or the IC may require the right to access Interconnection Facilities owned by the other party to perform testing or inspections. PPL EU and the IC will provide access to each other and comply with all safety rules applicable to the area and facilities.

Each party may, at its own expense, have the right to observe testing of the other party's facilities whose performance may reasonably be expected to affect the reliability of the observing party's facilities. The party performing the testing shall make reasonable efforts to notify the affected party in advance of any such testing.

If either party observes any defects or deficiencies on its own facilities or the other party's facilities that may reasonably be expected to adversely affect the other party's facilities, the observing party shall notify the affected party. The affected party shall take corrective actions in accordance with all applicable standards, rules, procedures, protocols, all applicable laws and regulations, and good utility practice.

12 Protection & Control

12.1 Philosophy

PPL EU has specific protection and control requirements for Interconnection Customers (IC) to connect to the PPL EU Transmission System. There are generally two sets of protection packages required by PPL EU to be installed at the IC's facilities: Point of Contact Protection (POC) and Intertie Protective Relay Protection (IPR).



The POC protection package applies to all Generation and End-User Facilities.

The IPR protection package applies to Generation Facilities operating in parallel with the PPL EU Transmission System. Note that all IC facilities shall have POC protection; the IPR protection package shall be added to the POC relay protection package if the IC installs generation, regardless of whether the IC's generation is directly connected to the PPL EU Transmission System or behind the meter of an End Use customer (See Behind the Meter Generation – BTMG in **Section 12.4.3.17**).

If the chosen POC protection package is relay-based (not fuses), then the POC and IPR protective relay functions shall be in separate protective relays; primary and backup sets of relays shall be provided for both the POC and the IPR protective relay functions. It is acceptable to one set of relays perform Primary POC and IPR and Backup POC and IPR protection, providing all requirements are met.

12.1.1 POC Protection

POC protection is required to protect the PPL EU Transmission System (and other ICs supplied from the same line) from faults in the IC's facilities. POC protection is not intended or specified to provide protection for the IC's equipment or facilities. The IC will need to provide additional protection devices to adequately protect IC facilities; any protection of the IC's facilities that is provided by the POC protection is coincidental and shall not be relied upon for comprehensive protection of the IC's facilities.

For ICs connecting at 69 kV, with no intention of adding generation, fuses are an option for POC protection; this option should be discussed at the beginning of the design process. If the IC adds generation at some future time, the IC will be responsible to replace the 69 kV fuses with 69 kV circuit breakers and related protective relays, at the IC's expense.

For chosen POC protection packages that are relay-based (not fuses), the current transformers (CTs), voltage transformers (VT) [potential transformers (PTs) or coupling capacitor voltage transformers (CCVTs)], main protective relays, auxiliary relays, and tripping contacts used in the POC circuits shall be reserved exclusively for protection of the PPL EU Transmission System; totally separate facilities shall be provided for the IC's protection. No additional relaying, metering, or monitoring devices may be included in the CT circuit or VT circuit designated for POC protection.

In general, the PPL EU standard POC relay protection packages, consisting of separate primary and backup relays, require separate phase and ground, time and instantaneous overcurrent protection relays (50/51, 50N/51N) per package, to initiate operation of the POC circuit breaker to isolate the customer's equipment from the PPL EU system in cases when the customer's own protective schemes fail to identify and isolate internal faults.

The fuse choices or relay settings shall be specified to provide the best possible protection for the PPL EU Transmission System from faults in the IC's facilities; these settings may not

coordinate with the IC's low side protective devices or provide complete protection of the IC's facilities.

12.1.2 IPR Protection

Any IC with generation operated in parallel with the PPL EU Transmission System is required to install primary and backup IPR relay protection packages, which trip circuit breaker(s) installed as a fault interrupting device. The amount of required protection applied to a particular generator installation will vary with the specific location on the PPL EU Transmission System—IPR packages could contain overvoltage (59), undervoltage (27), over-frequency (81O), under-frequency (81U), directional power or reverse power (32), breaker failure (86BF), directional distance (21), synchronism check (25) relays, timers and other equipment. The actual protection functions employed for a specific customer installation will be determined at the design stage via discussions between PPL EU and the customer. The amount of required protection applied to IC facilities will depend on its classification type and specific location on PPL EU Transmission System. The classification types are described in more detail later in this document.

The primary function of the IPR packages is to isolate the IC's generation from the PPL EU Transmission System for faults on PPL EU facilities; the secondary function is to block closing of all circuit breakers that can be used to connect the IC's generation to the PPL EU Transmission System whenever the PPL EU facilities are unavailable or abnormal.

In addition, the IPR requirements include Direct Transfer Trip (DTT) — a communication channel between the IC's facilities and the PPL EU facilities used to isolate generation from the PPL EU Transmission System. There are two types of DTT:

Unidirectional DTT—For IC facilities connected via direct line taps, PPLEU will transmit a DTT signal over an IC-owned communication system for the following purposes:

- Anti-islanding—Ensures tripping of IC's Generation Facilities when no longer connected with respective source PPL EU Substation(s).
- Breaker failure (BF) —Trips Generation Facilities when BF occurs at respective source PPL EU Substation(s).

Bidirectional DTT—For ICs connected at a dedicated PPL EU Substation terminal, PPL EU will transmit and receive DTT signals over IC-owned communication system for the following purposes:

- PPL EU BF—Trips Generation Facilities when BF occurs at respective PPL EU Substation.
- IC BF—Trips PPL EU Substation breaker(s) when BF occurs at Generation Facilities.

The DTT scheme is the primary scheme to reliably remove the Generation Facilities upon any of the conditions noted above.

For PPL EU interconnection, PPL EU Supervisory Control and Data Acquisition (SCADA) Remote Terminal Units (RTUs) will **not** be required as part of the PPL EU protection package since the PJM requirements include this equipment. PPL EU shall obtain the desired data quantities from PJM; this eliminates the need for the IC to provide two separate SCADA Remote Terminal Units (RTUs).

PPL EU has a list of acceptable relays for POC and IPR protective relay functions, reference **Attachment C – PPL Pre-approved POC/IPR Equipment**. All relays for POC and/or IPR protective relay functions must be selected from this list.

12.2 Specific Requirements Common to both POC and IPR Protection

12.2.1 POC and IPR Current and Voltage Transformers

PPL EU will review the VT (CCVT or PT) and CT ratios for all devices required for the POC and IPR relaying packages. PPL EU requires WYE-connected VTs and WYE-connected CTs. These VTs and CTs shall be relaying class accuracy and be able to support the connected burden during both normal load and fault conditions. Typically, VTs with 200 VA or 400 VA accuracy burden rating and 1000 VA thermal burden rating and class C200, multi-ratio bushing CTs will be acceptable for facilities using discrete relays, but these values shall be confirmed to be acceptable by PPL EU for each application. Equipment with lower ratings shall also be reviewed by PPL EU.

For Generation Facilities which are subject to PJM approval, the IC shall also ensure that the CTs and VTs used to provide PJM SCADA and metering information meet the PJM requirements as discussed in “PJM Manual 01: Control Center and Data Exchange Requirements”.

Upon request, PPL EU will supply fault current data at or near the point of interconnection (POI) to facilitate the proper sizing of protective equipment.

The CTs, main protective relays, auxiliary relays, and tripping contacts used in the POC circuits are reserved exclusively for protection of the PPL EU Transmission System; totally separate facilities shall be provided for the IC’s protection. No additional relaying, metering, or monitoring devices may be included in the CT circuit or VT circuit designated for POC protection. Similarly, the fuse choices and relay settings are specified to provide the best possible protection for the PPL EU Transmission System for faults in the IC’s equipment; these settings may not coordinate with the IC’s low side protective devices or provide complete protection of the IC’s equipment.

NOTE: CT and VT secondary connections for POC and IPR relaying may be shared; however, these secondary connections are NOT to be shared with any IC or generation relaying, or revenue metering. If potential devices with two or more secondary windings are used, relay and metering functions may share the same potential device if separate secondary windings are assigned to each of the following: IC protection functions, POC and IPR protection functions, and revenue metering functions.

ATTENTION: (CCVTs/CVTs) located on the PPL EU side of the POC circuit breaker(s) shall have adequate primary (high voltage) fusing to protect PPL EU facilities from equipment failure.

12.2.2 Microprocessor-Based Relays, Programmable Logic Controllers (PLCs), Tripping Sources and Remote Alarms

Multifunction Microprocessor-Based Relays

The IC must choose multifunction microprocessor-based relays from the list, **Attachment C – PPL Pre-approved POC/IPR Equipment** to provide the POC and IPR protection functions for their substation.

Power sources that supply microprocessor-based relays shall be uninterruptible.

With the trend to using microprocessor-based relays, and the tendency to include all the required POC or IPR protection in (separate) single devices, the impact of failure of one device shall be considered. PPL EU requires that two (2) independent relays (or packages) be provided for each protection scheme (i.e., one Primary relay for the POC/IPR protection and one Backup relay for POC/IPR), such that failure of one relay will allow continued operation of the IC's facility until the failed relay can be repaired or replaced. In some cases, separate POC and IPR protection may be required.

For all installations, the preferred relays are microprocessor-based units with multiple functions. These relays provide many of the above functions in one device case as well as sequence of events capability. All microprocessor-based relays are to be ordered with suitable ports and communication software to allow setting and transferring of data from a laptop computer.

Customer Control logic, i.e. restoration, in microprocessor POC and IPR relays shall not be used to provide control functions of the POC breaker. For these types of applications separate customer relays will be required.

Programmable Logic Controllers

When ICs choose Programmable Logic Controllers (PLCs) for POC and/or IPR control functions, all POC and IPR breaker tripping shall be accomplished via relay hard-wired control circuits and shall operate independently of the PLC controls. This is required for trip functions from:

- IPR relays and POC relays (including differential and/or summation over-current relay schemes, if considered to be part of the POC protection package).
- Control switches—trip and closing functions.
- Automatic source transfer schemes (such as are permitted at IC substations with two supply sources, including IC-owned generation).

PLC control schemes are permissible for automatic operations such as source transfers of the POC breakers, but the PLC controls shall be “backed up” or duplicated by hard-wired interlocks provided to prevent paralleling the utility supply lines.

Tripping Sources and Remote Alarms

POC breaker trip controls shall be via DC supply. Provisions shall be made to remotely monitor DC power sources, microprocessor-based relays, and PLC failures. In general, all device alarms (such as loss of AC potential, relay failure, loss of control power, battery charger alarms, etc.) shall be connected to a central annunciator or monitoring panel.

All POC/IPR related alarms (whether indicating lights, annunciators, or horns/strobe lights), shall be routed to a supervised location where the alarm condition will be noticed and analyzed in a timely manner.

All inputs and outputs of any protective relaying shall be isolated from the relay by a test switch. A switch is required on each side the outputs for testing purposes. PPL EU shall be notified of these alarms, and corrective actions planned, as soon as possible.

12.2.3 Tripping Relays

The current microprocessor-based protective relays typically provide multiple tripping and block closing contacts. These contacts shall be connected to directly trip and directly block closing of the required breaker.

When a normally de-energized auxiliary relay or lockout is used to trip and block closing of the generator or other breaker, the IC shall install suitable equipment to monitor continuity of this relay coil, without affecting operation. This additional equipment shall be mounted in the POC and IPR cabinet.

NOTE: Under no circumstances are the POC and/or IPR relays to trip through a PLC (programmable logic controller) or other programmable device. The POC and IPR relays shall trip directly to avoid any additional time delay for an interposing programmable device. Auxiliary relays can be used only if necessary. The trip signal may be monitored by a PLC or other programmable device to facilitate control functions at the IC's facility.

The interconnection relay system shall have the capability to withstand electromagnetic interference (EMI) environments (as per IEEE Std. C37.90.2-latest version) so that the influence of EMI shall not result in a change of state or mis-operation of the interconnection system.

There shall be no means of network routable protocol connections to the relay, i.e., ethernet, plugged into the relay.

12.2.4 Indication and Metering, Synchronism Check, Etc.

All installations shall include:

- An ammeter and an ammeter switch to monitor all three phases or a suitable 3-phase digital display. For projects using microprocessor relaying where these values can be displayed on the front of the relay, separate meters will not be required.
- A visible semaphore on each of the breakers between the generator and the PPL EU Transmission System to determine the actual status of the breaker (open or closed).

- To prevent a possible undesirable (out-of-phase) connection of the Generation Facilities to the PPL EU Transmission System, synchronous generators will require a synchronism check relay (25). Induction generators require a voltage check relay (27). These devices shall be mounted in the POC and IPR cabinet and connected to prevent closing of the generator circuit breaker, or other breaker as agreed to by PPL EU, for:
 - An out-of-phase condition.
 - A de-energized line condition (PPL EU supply breaker open).
 - A de-energized synchronous generator condition.
 - An energized induction generator condition.

When a synchronism or voltage check relay is required, the IC shall install a relay-accuracy class voltage transformer on the generator side of the generator breaker, or other breaker as agreed to by PPL EU, to supply potential to this relay.

12.2.5 Current and Potential Circuit Grounding

Neutral circuits shall not be confused with the station ground. All current and potential neutrals are to be isolated from all other circuits and grounded at one point only at the POC and IPR cabinet, on the cable side of the isolating links.

Whenever a CT is installed and the secondary is not used, the CT shall be shorted and grounded.

12.2.6 Responsibilities

12.2.6.1 POC/IPR Relaying Responsibilities

The IC is responsible for purchasing, installing, commissioning, owning, and maintaining the POC and IPR relaying equipment, including the DTT communication equipment. However, PPL EU is responsible for controlling these devices. The following clarifications to responsibilities also apply:

- The IC shall select POC and IPR relaying from **Attachment C – PPL Pre-approved POC/IPR Equipment**.
- DTT communication will be determined based on PPL EU's standard equipment in use at the time of construction; the IC's selection must be compatible with equipment currently used.
- PPL EU shall provide the IC relay protection settings for the POC/IPR relaying to ensure optimal coordination is maintained with the PPL EU Transmission System. The IC shall be responsible for any logic settings in POC/IPR required for their application.
- POC/IPR Relay setting files will need to be downloaded from relays at site. PPL will need access when these relays are initially powered up.
- PPL EU shall provide the IC relay protection settings for the POC/IPR relaying to ensure optimal coordination is maintained with the PPL EU Transmission System. The IC shall be responsible for any logic settings in POC/IPR required for their application.
- PPL EU shall have the option to perform or witness all POC/IPR relay testing.

- The IC shall contact PPL EU prior to performing any maintenance on the metering or POC/IPR/DTT relaying equipment.
- The IC is responsible for all costs required for maintenance or replacement of the POC and IPR protection packages.

12.2.6.2 Communication Channel Responsibilities

PPL EU will determine if direct fiber is feasible on a per project basis. For Telecommunication DTT, IC will be responsible for making the necessary arrangements with the local telecommunication vendor; refer to **Attachment A – Telephone Circuit Guidance** for further information.

Under no circumstances shall DTT communication signal be internet based.

The matrix below indicates responsibility relating to the DTT communication media type and equipment:

RESPONSIBILITY	TELECOMMUNICATION (TELCO) PROVIDER⁹	DIRECT FIBER
Purchasing	IC ^{1,2,4}	IC ^{2,3,4}
Specifying	PPL EU	PPL EU
Installing	IC ⁵	IC ³
Commissioning	IC ⁶	PPL EU ⁷
Owning	IC	IC ⁸
Maintaining	IC ¹⁰	IC ^{8,10}
Controlling	IC ¹¹	IC ⁸

Table A2.7-1 – Communication Channel Responsibilities

¹The IC shall also be responsible for all costs associated with the leasing of the telephone lines and resolving any problems with the telephone service provider.

²The IC shall contact PPL EU prior to purchasing any equipment.

³The IC shall be responsible for the portion required to interconnect with the PPL EU fiber system. PPL EU will make arrangements for connections between the IC’s fiber and the PPL EU fiber splice box.

⁴The IC shall contact PPL EU prior to purchasing or specifying any equipment.

⁵The IC shall also be responsible for coordinating the telecommunication provider’s installation of communication equipment at the PPL EU facilities. PPL EU shall witness all installation performed by the IC at PPL EU facilities.

⁶The IC shall perform end-to-end testing, covering the entire communication path from IC communication equipment to PPL EU communication equipment, with support from PPL EU. The communication path begins at the communication port on each relay and typically encompasses the segments of cable and telephone company-owned interfacing equipment inside the control house before entering the telephone line or fiber enclosure. The telephone company is responsible for ensuring any equipment they own inside the control house also works correctly during commissioning testing. PPL EU shall witness all testing.

⁷The IC shall perform end-to-end testing, covering the entire communication path from IC communication equipment to PPL EU communication equipment, with support from PPL EU. The communication path begins at the communication port on each relay and typically encompasses the segments of fiber interfacing equipment inside the control house before entering the fiber enclosure. PPL EU shall perform testing from the PPL EU Substation fiber splice box to the IC substation fiber splice box, with support from the IC. Both PPL EU and the IC shall witness all testing.

⁸The IC shall own, maintain, and control all communication equipment up to the PPL EU Substation fiber splice box, including the portion along the generator lead line. PPL EU requires all communication equipment have locking provisions wherever necessary.

⁹If a leased telephone line is to be used for communication, the following items shall be considered: (a) The IC is responsible to arrange for the leased telephone channel (if available) - lead times can be six months or more; (b) The cost of the leased telephone installation and monthly charges are the IC's responsibility; (c) Teleco providers have strict requirements for physical entrance facilities for their channels and it is the IC's responsibility to determine these requirements; (d) The IC shall discuss with PPL EU in advance to determine the acceptable circuit parameters for the leased telephone channels.

¹⁰The IC shall contact PPL EU prior to performing any maintenance on the communication equipment.

¹¹The IC shall also be responsible to purchase, install (or arrange for installation) maintain (or arrange for maintenance) and control all communication equipment for leased telephone lines at the PPL EU facilities. PPL EU recommends all communication equipment have locking provisions wherever necessary.

¹²For ICs that currently have leased telephone circuits, PPL EU will review any requests to migrate to PPL fiber on a case by case basis. In general, migration from a telephone circuit to PPL EU fiber depends on a) fiber availability on PPL EU's Transmission System and b) reliability or obsolescence issues with the leased telephone circuit.

12.2.7 PPL EU Test Procedures

PPL EU provides technical representatives to review the design and accept all IC Point of Contact (POC) and Intertie Protective Relay (IPR) installations involving systems with protection relays.

PPL EU technical representatives shall be included in early design review to facilitate acceptance of POC and IPR installations.

As the POC and IPR work progresses to the physical construction stage, PPL EU will participate in an initial "on-site" job meeting to develop a work plan to support testing and acceptance activities required to connect the IC facilities to the PPL EU Transmission System.

These items related to POC and IPR related protection equipment include:

1. Relay acceptance tests and application of settings (issued by PPL EU)
2. POC/IPR Relay setting files will need to be downloaded from relays at site. PPL will need access when these relays are initially powered up.
3. Current Transformer tests
4. Current Transformer saturation tests
5. Current circuit verification
6. Potential circuit verification
7. Control circuit tests
8. Communication circuit verification (for DTT circuits)
9. In-service verification tests
10. Securing the relays from tampering by: use of a PPL EU padlock to the handle of the IPR cabinet, applying software passwords, and/or by applying a PPL EU seal, as applicable to the relay type.
11. Resolution of any issues identified by PPL EU related to the POC and IPR systems.

PPL EU personnel will complete items 1, 7, 8 and 9. Items 2 through 6 and 10 shall be completed by the IC or their contractor and witnessed or verified by a PPL EU representative.

The testing phase of the project will be documented with applicable Asset Commissioning Forms.

PPL EU personnel will require a written commissioning procedure proposed by the IC's contractor. This procedure shall cover a step-by-step listing of the tests required to ensure that the IC's POC and IPR schemes operate properly. This commissioning procedure shall be supplied to PPL EU at least two weeks prior to the scheduled in-service testing process. The IC shall provide a detailed procedure for PPL EU review of the initial phase-out and synchronization. This shall be reviewed prior to actual synchronization (generally only larger systems).

One of the responsibilities of PPL EU personnel is to secure the POC and IPR relays upon successful completion of the commissioning procedure. The POC and IPR cabinet required to house the POC and IPR relay packages must be supplied with a cabinet door suitable for securing with a suitable lock. In addition, the POC and IPR relays can be secured via use of passwords to limit access. The POC and IPR protection equipment is installed to protect the PPL EU Transmission System from adverse effects of the IC's equipment. For this reason, control of this equipment shall remain with PPL EU.

PPL EU will assume control of the POC and IPR equipment and will witness all testing performed by IC personnel or contractors.

PPL EU will observe verification of the correct operation of the generator isolation breaker synchronizing circuit.

The IC is to verify the phase rotation of the generator. Please note that the PPL EU 230 kV system rotation is C-B-A; the 500 kV system rotation is A-B-C (the phase change is accomplished at the terminals of the 500-230 kV transformers). The generation IC is expected to verify with PPL EU the specific rotation at their facility.

There shall be no means of network routable protocol connections to the relay, i.e., ethernet, plugged into the relay.

12.2.8 Protection and Control Cabinet

PPL EU requires control of the POC and IPR protective relaying packages, including the DTT schemes. This control shall be provided by a dedicated locked cabinet which contains all the POC and IPR relays, auxiliary relays, and DTT equipment with a PPL EU lock on the cabinet door (additionally, passwords may be applied on the relays). The POC and IPR relay packages are provided strictly for protection of PPL EU's system from issues in the IC's facilities. No IC's generation or other equipment protection or control logic is to be implemented in the POC and/or IPR relay packages. PPL EU will specify relaying requirements for the generation installation.

PPL EU personnel shall have access to the locked POC and IPR cabinet. A procedure shall be in place for PPL EU personnel to contact the IC to arrange for access in a timely manner.

This POC and IPR cabinet is to be located inside of a suitable building to protect the sensitive electronic equipment from the weather and to provide shelter during maintenance activities.

IEEE 1547 compliant equipment for the IC's generator protection will typically be housed or otherwise included in the generation facility, not in the POC and IPR cabinet. For this reason, the specifications included in this PPL EU document will not apply to the IC's generation protection equipment. If protection, control, or monitoring equipment is required in addition to the IEEE 1547 compliant equipment, then these PPL EU requirements shall be followed as closely as possible for the proposed installation. Special purpose schemes may be required depending on the impact of the facility.

12.2.8.1 Cabinet General Design

- Only POC and IPR relays as detailed by PPL EU may be installed in the POC and IPR cabinet. These relays will NOT contain any IC or generation logic, interlocks, alarms, or controls.
- The IC will furnish all equipment required for the POC and IPR cabinet.
- All component (relay, resistor, fuse, etc.) ratings and ranges for the POC and IPR packages shall be reviewed by PPL EU.

- The IC is requested to identify PPL EU as the end user to all suppliers of protective relays and switches. In general, PPL EU will control the equipment, PPL EU requests vendor notification for possible firmware updates or manufacturers' service bulletins.
- The maximum voltages allowed in the cabinet are 140 VDC and 240 VAC nominal. Any voltages above this level shall be barricaded and labeled.
- All relays shall be current production utility grade relays and shall be reviewed by PPL EU. PPL EU will supply a list of currently approved vendors; see **Attachment C – PPL Pre-approved POC/IPR Equipment**.
- PPL EU will inspect the cabinet prior to assuming operational control; any deficiencies shall be corrected by the IC before acceptance.
- The IC is responsible for mounting the cabinet in an easily accessible location. The IC shall provide an access procedure to PPL EU for accessing all equipment under the responsibility of PPL EU.

12.2.8.2 Equipment Cabinet Details

For indoor installations there shall be a minimum three (3) feet access in front of any serviceable area on the panel. Any other structures or cabinets shall not obstruct full opening of the doors.

Following are the guidelines for the POC and IPR equipment cabinet:

General Construction

The cabinet minimum size shall allow easy access to all components and if equipped, shall not restrict motion of internal swing panel.

- POC and IPR cabinets shall conform to specifications for a NEMA Type 4 Enclosure. Specifications for these enclosures are contained in NEMA Standard ICS 6 (latest version).
- Single-door cabinets will need the following:
 - A three-point latch handle on the door with provisions for PPL EU's padlock (3/8" hole).
 - A latch or equivalent to keep the door in the 100-degree and 120-degree open positions and hold it there if so desired. A permanent stop shall be provided so that the door will not be opened beyond the 120-degree open position.
 - A latch or equivalent to keep the hinged equipment panel in the open position or the fully closed position and hold it there.
 - All components and wiring shall be accessible from the front door.
- Double-door cabinets shall meet all requirements as single-door cabinets except for the following:
 - All components and wiring shall be accessible from the front (and/or rear) doors. If all components are not accessible from the doors, then the cabinet shall have a continuously hinged panel opening in the same direction as the front access door.

The IC shall provide a PPL EU Control Switch (PCS), located in the POC and IPR cabinet for PPL EU use. This switch will provide the capability to locally disconnect the IC's generation from the PPL EU Transmission System by opening the POC breaker or the designated generator isolation breaker when circumstances require manual disconnection. A standard PPL EU control switch (an example is: General Electric Company Type SB-1, Model 16SB1B2X2) or equivalent (subject to PPL EU approval) with target, sliding contacts, handle, and configuration shall be used for the PCS. See **Attachment B – Details for PPL EU Control Switch** for switch details and wiring information. Alternative suppliers for this equipment will be considered if the functional requirements are met.

The PCS shall be a three-position switch with spring return from close to normal and from trip to normal. The "Close" position shall be to the right of "Normal" and the "Trip" position shall be to the left of "Normal." This will maintain compatibility with standard PPL EU controls.

One duplex 120 VAC, 15-amp, receptacle shall be in the cabinet or within 10 feet of the cabinet and shall be accessible for PPL EU use. This circuit cannot be supplied by the VT's used for relaying.

Cabinet is to be labeled "Generation name—POC and IPR cabinet" in black letters with a yellow background and a minimum lettering height of 1".

12.2.8.3 Wiring Guidelines

General

All wiring shall be installed per Latest NEC standards.

- ADD NEC reference for wiring guidelines
- Wiring and device location shall not prevent the removal of any equipment or block access to equipment for inspection and maintenance.
- All protective relays or IEDs (Intelligent Electronic Devices) shall be connected through an external test device (i.e., FT-1 or similar as determined and accepted by PPL EU). All inputs and outputs for protective relays, IEDs, and analog sensing devices are to be connected through suitable test switches. Further, the switches are to be connected to allow the isolation of the device and the injection of current or voltage without disturbing other devices that may be connected to the same CTs or VTs. The test switches shall be wired such that the hinge end of the switch is connected to the relay/IED. The outputs should be isolated on both sides of the contact and the inputs should be isolated on the DC + side.
- A suitable means of identifying the conductors or wiring shall be employed to provide a method to trace the wiring.

Terminal Blocks



- Terminal blocks shall be mounted such that the connections and links are accessible and not blocked by projecting equipment.
- Terminal blocks shall be mounted a minimum of 6" from sidewalls and adjacent equipment and a minimum of 4" above the bottom of the housing.
- Terminal blocks shall be mounted such that the sliding link:
 - Falls closed when loosened, if mounted in horizontal rows.
 - Moves toward the front of the cabinet when opened, if mounted in vertical rows on side panels.
 - Moves away from the panel centerline when opened, if mounted on the rear panel.
- There shall be a minimum of 10% spare terminals included in the cabinet for modifications.
- Phoenix Contract sliding link block Type OTT-6-T-P-P, or equivalent for CT circuits and Type USST-6-T, or equivalent, for potential and i/o circuits.

Terminal Connections

Wires terminating on a threaded stud such as a relay terminal will be terminated with ring tongue lugs, which completely encircle the screw or the stud. The crimping tool shall be suitable for the connectors used.

Wires terminating in a screw-clamp will not require any type of lug since the terminal block will accept a bare, properly stripped wire. Sufficient torque shall be applied to each screw to secure the wire firmly in the yoke.

Nameplates/Device Identification

Suitable nameplates shall be applied to the various pieces of equipment to avoid miscommunication or switching errors. The actual text on the nameplates shall be shown on the drawings for PPL EU review.

The same wording on these nameplates shall be referenced in any operational instructions.

Below is a typical list of nameplate schedules.

HORIZONTAL DIMENSION (inches)	VERTICAL DIMENSION (inches)	HEIGHT OF LETTERS (inches)	WHERE USED
2-1/2	1	7/32	All primary circuits on generating or substation switchboards (up to two lines)



2	3/4	1/8	Equipment on switchboards or in cabinets (up to 3 lines)
2-1/4	1-1/2	1/8	Equipment on switchboards or in cabinets (up to 3 lines)
4	1	1/8	Equipment on switchboards or in cabinets (up to 4 lines)
3-5/8	3/4	1/8	3 gang fuses and indicating lights (up to 3 lines)
2-3/4	1-1/4	1/8	Equipment on switchboards or in cabinets (up to 5 lines)
4-1/2	1	7/32	Small cabinet doors (up to 2 lines)
8	2	1/2	Large cabinet doors (up to 2 lines)
3-1/2	1-1/4	7/32	Identification on front and back of switchboards (up to 3 lines)

Table A12.2.9-1 – Nameplate Schedule Dimensions

12.2.9 Drawing Requirements

In general, PPL EU requires drawings showing the POC and IPR equipment, high voltage isolating switch interlocks, and the circuit breaker controls for the isolating breaker(s) and generator breakers.

PPL EU will review elementary, front view, bill of material, and Description of Operation drawings provided by the IC. Wiring diagrams or lists will not be reviewed in detail.

Panel construction shall not begin until PPL EU has reviewed the elementary drawings.

The IC is responsible for the accuracy of all drawings.

The IC shall supply "As-Built" drawings, the Description of Operation, and instruction books for relay switches, auxiliary relays, VT, CT, and any other devices as requested by PPL EU, prior to final acceptance of facility.

The IC shall supply copies of the drawings listed below for review by PPL EU. Drawings shall be submitted electronically in.pdf format. The drawings will be assigned a PPL EU drawing number, entered into the PPL EU drawing system, and re-issued as the 'drawings of record' for the IC's installation.

All .pdf files received must be compatible with PPL PDF Software

All drawings shall be suitable to be scaled to "D" size (24 inches by 36 inches), except for reports, word, or excel documents. Reduced size drawings are not acceptable.

12.2.9.1 Drawings and Information for Review

PPL EU's Protection and Control Engineering section will require the following drawings/information for review and acceptance:

- Protection and Control One Line Diagram *
- Three Line Diagram *
- Plan and Elevation Views (electrical arrangements only)
- Grounding Plan and Details
- Ground Test Report (IC substation is complete but before PPL EU supplies are connected) *
- Bill of Material (major electrical equipment only, including switch, protective device, transformer, surge arresters, relays, etc.) *
- Switch Interlock Schematic and Details
- Three Line Potential Elementary *
- Three Line Current Elementary *
- Control Elementaries
- Power Transformer Certified Test Report(s) *
- Front view showing POC Relay and Control Equipment *
- A detailed written description of Point of Contact (POC) and Intertie Protective Relay (IPR) protection and control functions and description of operation to include the following: *
 - Point of contact breaker or low side circuit breaker *
 - Generator circuit breaker
 - Controls associated with the above circuit breakers *
 - Any other equipment that connects to the above breakers *
 - System interlocks
 - Direct Transfer Trip equipment
 - General description of the operation of the facility, including operational modes (parallel, isolated, peak shaving, etc.)
 - Any other unique facilities or operational modes
 - High side breaker isolation procedure, if an SF6 high side breaker is used
 - Commissioning procedure *
 - POC and IPR relay instruction books *
 - POC and IPR CT saturation study *
- I/O Table for POC and IPOR Relays

* Denotes drawings which shall be supplied for every type of IC facility. Other drawings shall be supplied as applicable to Generation Facilities or Transmission Facilities.

12.2.9.2 Protection and Control One/Three Line Relay Diagrams

This drawing shows the IC's substation functional arrangement. All the equipment shall be shown using single-line diagram and standard symbol notations (per latest ANSI/IEEE Standard 315 "Graphic Symbols for Electrical and Electronics Diagrams"). This drawing shall include:

- Equipment names and/or numerical designations for main breakers, air switches, power transformers, and associated POC and IPR relays and control devices shall be shown to match with PPL EU line designation. Note that the required information will be provided by PPL EU after the IC submits a preliminary one line diagram.
- Power Transformers - Nominal kVA, nominal primary/secondary and tertiary voltages, vector diagram, and impedance.
- Instrument Transformers - Voltage and Current that supply the POC relaying.
- Lightning Arresters/Spill Gaps/Surge Capacitors - Ratings.
- Air Switches - Indicate status normally open with a (N.O), normally closed with a (N.C.), and type of operation – manual or motor.
- Safety Switch - Continuous ampere and interrupting ratings.
- FIDs - Interrupting rating, continuous rating, and operating times.
- Transformer Fuses - Size, type, manufacturer, and location.
- Grounding.
- Generator(s) - Include type, connection, kVA, voltage, current, phasing, rotation, PF, etc.
- Point of Connection to PPL EU and phase identification. Note: if the generation phase sequence is different than the PPL EU phase sequence, both shall be shown on this diagram.

12.2.9.3 Current Elementary Diagrams

- Terminal designations of all devices - Relay coils and contacts, switches, transducers, etc.
- Relay Functional Designation - Per latest version of ANSI/IEEE standard C-37.2. The same functional designation shall be used on all the drawings showing the relay.
- Complete relay type such as "SEL 751", etc., and the relay range.
- Range and settings of timing relays.
- Switch developments and escutcheons shall be shown on the drawing where the majority of contacts are used. Where contacts of a switch are used on a separate drawing, that drawing shall be referenced adjacent to the contacts in the switch development. Any contacts not used shall be referenced as spare.
- All switch contacts are to be shown in the open position with each labeled to indicate the positions in which the contacts will be closed.
- Switch contacts shall be referenced to the switch development if development is shown on a separate drawing.
- Isolating points (Sliding links, test switches, etc.).
- Grounding of CT cables.
- All other circuit elements and components with device designation, ratings, and settings where applicable.
- Current Transformers - Polarity marks, rating, tap, ratio, and connection. Include the rating factors and accuracy classes (i.e., 2000/5 amp, C800/0.3 B1.8).
- Auxiliary CT ratios, connections, polarity, winding current rating, and arrows to indicate assumed current flow.

- Phase designations and rotation of both PPL EU and IC.
- Cable connection number or wire designation.

12.2.9.4 Potential Elementary Diagrams

- Terminal designations of all devices – relay coils and contacts, switches, transducers, etc.
- Relay functional designation – per latest version of ANSI/IEEE standard C-37.2. The same functional designation shall be used on all the drawings showing the relay.
- Complete relay type such as "SEL 751", etc., and the relay range.
- Relay contacts shall be referenced to the drawing when the coil is shown, provided the coil is shown on a separate drawing.
- Relay contacts shall be shown with each referenced to the drawing where they are used. Contacts not used shall be referenced as spare.
- Range and settings of timing relays.
- Switch developments and escutcheons shall be shown on the drawing where most contacts are used. Where contacts of a switch are used on a separate drawing, that drawing shall be referenced adjacent to the contacts in the switch development. Any contacts not used shall be referenced as spare.
- All switch contacts are to be shown in the open position with each labeled to indicate the positions in which the contacts will be closed.
- Switch contacts shall be referenced to the switch development if development is shown on a separate drawing.
- Isolating points (Sliding links, test switches, etc.).
- Grounding of cables.
- All other circuit elements and components with device designation, ratings, and settings where applicable.
- Coil voltage for all auxiliary relays.
- Potential Transformers – nameplate ratio, polarity marks, rating, primary and secondary connections. Include accuracy class and burden (i.e., 40250/115 0.15 WXYZ).
- Phase designations and rotation of both the PPL EU and IC.
- Current ratings and designation of all fuses.

12.2.9.5 Control Elementary Diagrams

Control elementary diagrams are to be functionally complete schematics. They shall be as simple and uncluttered as possible, and shall contain the following information:

- Terminal designations of all devices – relay coils and contacts, switches, transducers, etc.
- Relay functional designation – per latest version of ANSI/IEEE standard C-37.2. The same functional designation shall be used on all the drawings showing the relay.
- Complete relay type such as "SEL 751", etc., and the relay range.
- Range and settings of timing relays.

- Switch developments and escutcheons shall be shown on the drawing where most of the contacts are used. Where contacts of a switch are used on a separate drawing, that drawing shall be referenced adjacent to the contacts in the switch development. Any contacts not used shall be referenced as spare.
- All switch contacts are to be shown in the open position with each labeled to indicate the positions in which the contacts will be closed.
- Switch contacts shall be referenced to the switch development if development is shown on a separate drawing.
- Isolating points (Sliding links, test switches, etc.)
- All other circuit elements and components with device designation, ratings, and settings where applicable.
- Cable connection number or wire designation.
- Device auxiliary switches (FIDs, contactors) shall be referenced to the drawings where they are used.
- Any interlocks – electromechanical, key, etc.
- Coil target ratings – on dual ratings underline the appropriate tap setting.
- Complete internals for electromechanical protective relays. Solid-state relays may be shown as a “black box,” with power supply and output connections, but manufacturer’s instruction book number shall be referenced, and terminal designations shown.
- DC fuses protecting the Point of Contact relaying and breaker’s control circuit shall be monitored for blown fuse or open circuit with a yellow indicating light.
- The trip coils of lockout relays shall be monitored.
- The coils and contacts of all timers and lockout relays shall be wired through sliding links or equivalent terminal blocks to provide isolation for testing.
- Front view diagrams.
- This drawing will show the physical arrangement of all the control and protective equipment for the POC and IPR relaying and shall contain the following information:
 - Nameplates shall be provided for all switches, lights, and hand-reset lockout relays for identification.
 - The POC and IPR relays shall be mounted in the POC/IPR cabinet. The POC relays and the IPR relays shall be separately labelled.
 - The POC and IPR relays shall be mounted in the cabinet in such an order that equipment associated with the various phases will be in A-B-C (PPL EU phase names) order from top to bottom or from left to right when facing front of panel on which they are mounted.

12.2.9.6 Drawing Review and Acceptance Procedures

All protection and control drawings are subject to review by PPL EU. The elementary drawings (potential, current, and control), the bill of material for the POC and IPR protection packages, and the Description of Operation shall be reviewed and accepted by PPL EU. The IC is expected and required to submit all drawings required to completely review the POC and IPR design from

the VT and CT inputs, the DC supplies, to the trip and close coils of the controlled equipment as well as all interlock devices. This includes any manufacturer or subcontractor drawings. Note that all drawings shall be submitted electronically and shall be scalable to the original size for plotting.

Any changes or updates to the drawings need to be submitted prior to the PPL EU performing the protection settings. Any changes or errors will delay this process.

All drawings submitted to PPL EU for Generation Facilities shall be signed by a licensed Professional Engineer (PE) holding an active PE license credential (not subject to ongoing disciplinary actions) in the Commonwealth of Pennsylvania that is provided by the State Registration Board for Professional Engineers, Land Surveyors and Geologists which is verifiable in the Pennsylvania Licensing System (PALS).

All drawings are reviewed subject to this NOTICE:

This information was prepared from a review of IC drawings by PPL Electric Utilities. Drawing review applies only to the general arrangement of the facilities and the primary and the control equipment associated with the POC and IPR protection schemes. Neither PPL EU nor any person acting on behalf of PPL EU: (a) assumes any responsibility for the correctness of design, drawings, installation, or operation, or (b) assumes any liabilities with respect to the use of, or for damages of any kind resulting from the use of any comments disclosed in the review document.

Panel construction shall not begin until PPL EU acceptance has been obtained on the above drawings.

Protection and control drawings are required before relay settings can be prepared. Delay in receipt of necessary drawings may delay availability of energizing the IC.

The IC shall submit preliminary relaying drawings for PPL EU review and acceptance. These drawings shall be submitted before the IC's equipment is ordered to ensure that it meets PPL EU requirements.

The IC shall submit final relaying drawings for PPL EU review and acceptance before the IC's facilities will be allowed to be connected to the PPL EU Transmission System and placed in-service. PPL EU will not be held responsible for possible late connection of IC's facilities if drawings are not received in time for review.

The drawings submitted by the IC to PPL EU for review apply only to switching devices, and POC and IPR relaying.

12.2.9.7 Final As-Built Drawings

The IC shall provide to PPL EU Final as built drawings in .pdf format.

NOTE: Final As-Built drawings are required to be completed and submitted to PPL EU within 60 days of the initial synchronization to PPL EU Grid. Failure to submit such drawings may result in

the IC not being able to interconnect with the PPL EU Transmission System until the “As Built” drawings are received.

12.3 End-User Requirements

The point of interconnection for an IC facility will be defined by the term Point of Contact (POC), which defines the physical point where the IC’s facilities connect to the PPL EU Transmission System. Associated with the POC are the protective relay and control functions required by PPL EU to provide the necessary isolation of IC facilities under fault conditions either in the IC facility or on the PPL EU Transmission System. These protective systems will be referred to as the POC protection or POC relays.

ICs requiring service at 138 kV or 69 kV, with extremely large motors which could serve as energy storage devices and supply current back to the PPL EU Transmission System for supply line faults, shall consult PPL EU for the proper POC protection. These installations with large motors may require reverse power or directional current protection as part of the POC protection package.

12.3.1 Substation Classifications

Please note that PPL EU uses the following defined terms for various PPL EU and IC facilities’ configurations.

Type A

A substation that is sourced normally by a single PPL EU supply line. Also considered as Type A is an electrical facility served by two supply lines, with one line carrying the entire substation load and the second line as standby. Refer to Figure in Section 12.3.2.10.

Type AA

A substation that is normally sourced by two independent PPL EU supply lines which are not paralleled by the substation load bus but allows for the transfer and restoration of load in a “break-before-make” manner. Refer to Figure in Section 12.3.3.9.

Type B

A substation that is sourced normally by two independent PPL EU supply lines operated in parallel on the substation’s load bus. Loss of one supply line shall not result in loss of the substation’s load. Refer to Figure in Section 12.3.4.11.

12.3.2 Single Line Supply Substation – No Alternate Source (Type A)

12.3.2.1 Substation Configuration and Operating Philosophy

The Type A configuration normally provides service to the IC via a single line of supply. Supply can be provided at voltages of 138 kV and below.

For higher reliability, additional options are available at IC expense, upon consultation with PPL EU.

At 69 kV and 138 kV supply voltages, a power transformer is typically installed on the PPL EU line of supply.

Fault interrupting devices (FID) such as fuses (applicable only for 69 kV installations) or circuit breakers or equivalent are installed on the power transformer high side. A second FID, typically a circuit breaker, is installed between each transformer low side and the IC operating bus.

Note that 69 kV fuses are only allowed for POC protection at IC installations without generation. If the IC adds generation at some future time, the IC will be responsible to replace the 69 kV fuses with 69 kV circuit breakers and related protective relays, at the IC's expense.

12.3.2.2 Normal Operation

Under normal operating conditions, the transformer POC interrupting device is closed and the transformer is energized and carrying load.

At IC substations supplied with two independent lines, either line can be the normal source; the FID associated with the normal supply line is normally closed, and the FID associated with the alternate supply line is normally open.

12.3.2.3 PPL EU Supply Line Faults

Supply line faults are cleared remotely by PPL EU. When this action isolates the fault, the IC load is interrupted. For IC substations with two independent supply lines, the load can be transferred manually to the alternate supply line.

12.3.2.4 Power Transformer Faults

If a circuit breaker or other relay-operated device is the FID, a faulted power transformer will be isolated on the high voltage and optionally on the low voltage sides by the operation of protective high side over-current relays. At 69 kV IC substations where a high side transformer fuse is the FID, a faulted transformer is isolated by blown fuses. This action will isolate the IC operating bus from the fault and interrupt the entire IC load.

12.3.2.5 IC Operating Bus

At IC substations with 69kV or 138 kV service, the operating bus is not considered part of the POC relaying. The IC may provide specific protection for the operating bus at its discretion.

12.3.2.6 IC Equipment Protection

Additional protective relaying can be applied as required to protect IC equipment including the operating bus and transformers. These IC-specified relays can initiate a trip of the IC's high side and/or low side FID but are not considered POC relaying. These additional IC's relays shall be connected to separate CTs; they may not be connected to CTs used for POC protection relays.

PPL EU may comment on additional IC relaying, but these relay settings will not be specified nor applied by PPL EU.

If master trip relays are used to open the POC FID, separate master trip relays will be applied for the POC protection and the IC's additional protection; these two separate relay packages will not share a common master trip relay.

12.3.2.7 Automatic Reclosing

Automatic reclosing for single line supply substations is not permitted on the PPL EU supply side FID.

12.3.2.8 POC Protection Requirements

The following are the POC protection requirements for single line supply (Type A) substations:

Current Transformers

The IC's source FID shall be equipped with three multi-ratio current transformers (one per phase) for supply to the POC relays. These current transformers shall be located on the outermost position of the PPL EU supply line side of the FID bushings. If the IC is using differential protection, they may choose, with PPL approval, to utilize the outermost CT for the differential protection. All tap connections of the multi-ratio CTs shall be wired out to terminal blocks and be accessible for future CT tap changes.

The POC current transformers shall have a relaying accuracy class of C200 or better and be set on a tap such that the maximum available short circuit current does not produce saturation. The IC shall provide CT saturation study results to PPL EU.

The POC CTs shall have a voltage rating equal to the FID that they are mounted on or are associated with and shall meet the BIL insulation ratings as specified in Section 9.6.

These CTs shall not be used as supply to the billing metering equipment, nor any other IC protection or monitoring functions. If additional protection or monitoring functions are desired for the IC's use, additional current transformers shall be supplied suitable for the IC's applications.

PPL EU will review current transformer tap settings proposed by the IC or, if requested, will specify the CT tap settings. PPL EU will supply fault current data at the point of the IC's connection to facilitate the proper sizing of the CTs.

Protection for PPL EU Supply Line Faults

Supply line faults are cleared remotely by PPL EU. This action isolates the fault and the IC load is interrupted.

Protection for Power Transformer Faults

Transformer Fuses

At IC's substations with 69 kV service where fuses are installed, the IC shall provide 69 kV fuses which will be S&C Company type SMD-2B (SMD-3C units can sometimes be used if a larger interrupting rating is required—but the IC shall discuss with PPL EU before changing from the

standard SMD-2B). The fuse interrupting rating, link size, and characteristics shall be approved by PPL EU. The 69 kV POC fuses provide clearing for faults on the IC's equipment.

Over-current Relays

Three phase (inverse) and one ground (very inverse) time and instantaneous over-current relays connected to CTs on the PPL EU side of each 69 kV or 138 kV FID are required to detect faults in the transformer. This relaying shall trip the PPL EU-side POC FID.

PPL EU will approve the relay ranges and settings for these POC relays. The instantaneous attachments of either or both phase and ground relays may be blocked from operation by PPL EU.

See the table of acceptable relays for POC protection on **Attachment C – PPL Pre-approved POC/IPR Equipment**.

12.3.2.9 POC Control Requirements

Control

The FIDs (other than fuses) shall be equipped with hard-wired control switches for manual operation.

POC protective devices shall be hard-wired to trip the POC FID. POC relay trip contacts shall not trip the POC FID via any type of intermediate microprocessor.

Automatic reclosing of the POC FID is not permitted.

Indication

The closed position of the FID shall be monitored with a red indicating light.

The open position of the FID shall be monitored with a green indicating light.

The FID trip coil shall be monitored either by a yellow indicating light or by the red indicating light in series with the FID trip coil and an FID "a" auxiliary contact. A trip circuit monitor (TCM) is also acceptable. If the FID uses a capacitor trip device, the FID trip coil shall be monitored by a yellow light in series with a pushbutton. This will allow a manual test of the FID trip coil continuity without placing a constant current drain on the capacitor charge.

The trip coils of master trip relays shall be monitored with yellow indicating lights.

Power to control circuits for POC relaying, master trip relay circuits, and the FID control circuit shall be supplied via separate fuses. Each fuse shall be monitored for blown fuse or open circuit conditions with a yellow indicating light or annunciator drop.

Annunciator alarms shall be indicated or displayed in a location which is normally manned, so that any change of annunciator status is promptly noticed.

Test Facilities



POC relays shall be provided with isolation facilities so that all current and potential (if provided) inputs and trip contacts are wired through test points. If not provided by the manufacturer in the form of a draw-out relay case, additional test switches such as the ABB FT1 (or equivalent) shall be provided by the IC.

POC Commissioning

For the initial commissioning of an IC's facility, the POC relays will be set and tested by PPL EU personnel. PPL EU will also test the CTs (and VTs, if required) which supply the POC relays. Testing will include a full functional test, including tripping of the POC FID device.

IC Protection Schemes

The IC may supply protective relays in addition to the required POC relays, at the IC's discretion. These additional relays will be supplied from CTs and VTs separate from the ones used to supply the POC relays. These additional relays will be set at the IC's discretion. If the settings are provided to PPL EU, an attempt will be made to set the POC relays to coordinate with the IC's relays, but PPL EU cannot guarantee optimum coordination.

12.3.2.10 Type A Single Line Diagram

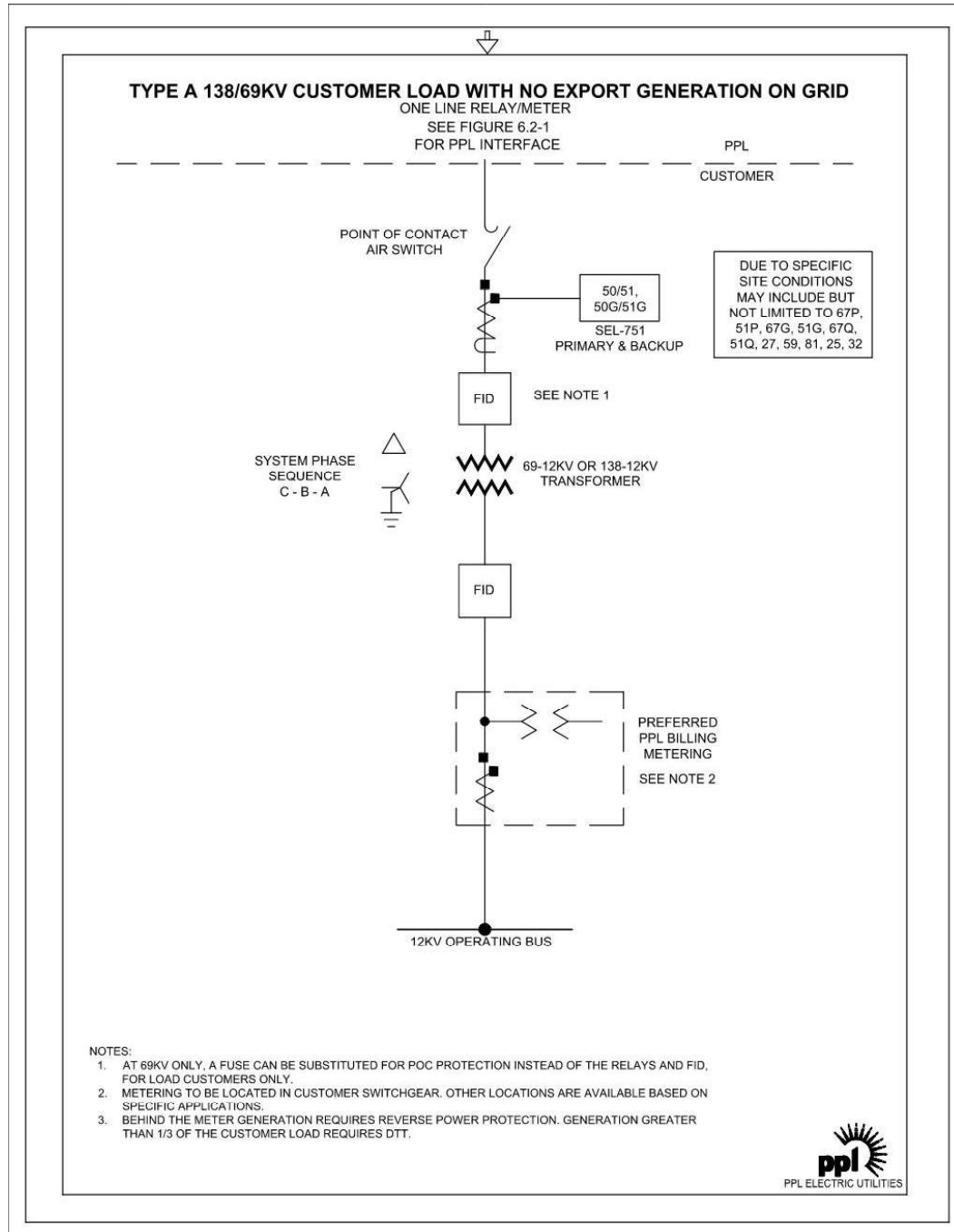

Figure 12.3.2.10-1 – Type "A" Customer Configuration.

12.3.3 Two Line Supply Substation - Open Tie Between Sources (Type AA)

12.3.3.1 Substation Configuration and Operating Philosophy

The two-line supply (type AA) configuration provides service to the IC via two independent lines of supply. During normal operation as discussed below, the supply lines are not paralleled via the IC facility operating bus. Both supply lines are normal sources. Low side FIDs are normally closed, while the bus sectionalizing FID is normally open. Supply can be provided at voltages of 138 kV and below.

On loss of either source, the low side FID associated with the lost source is tripped and the bus sectionalizing FID is closed. Thus, the IC can feed the entire load from one source. Automatic or manual schemes will return the system to normal operation (via break-before-make switching) upon return of the normal source.

At 69 kV and 138 kV supply voltages, a power transformer is typically installed on each PPL EU line of supply.

FIDs such as fuses (applicable only for 69 kV installations) or circuit breakers or equivalents are installed on the power transformer high side. FIDs or the equivalent are installed between each power transformer low side and the IC operating bus.

Note that 69 kV fuses are only allowed for POC protection at IC installations without generation. If the IC adds generation at some future time, the IC will be responsible to replace the 69 kV fuses with 69 kV circuit breakers and related protective relays, at the IC's expense

The operating bus is sectionalized with an FID other than a fuse to allow load transfer on loss of a supply line or power transformer.

12.3.3.2 Normal Operation

Under normal operating conditions, the bus sectionalizing FID is open, both transformer low side fault-interrupting devices are closed, and both power transformers are energized and carrying load.

12.3.3.3 Operation Under Fault Conditions

PPL EU Supply Line Faults

Since the supply lines are not paralleled through the IC's equipment, supply line faults are cleared remotely by PPL EU. This action isolates the fault, and the corresponding IC load is interrupted briefly until the bus sectionalizing FID closes to supply the interrupted IC load from the alternative line.

Power Transformer Faults

At IC substations where a high side fuse is the point of contact protection, a faulted transformer is isolated by blown fuses.

If a circuit breaker or other relay-supervised device is the FID, then a faulted power transformer will be isolated on the high and low voltage sides by the operation of protective high side over-current relays.

Either of the above actions would isolate the faulted power transformer and the IC operating bus from the fault. The entire IC's load is then supplied by the remaining PPL EU line.

12.3.3.4 IC Operating Bus

Each IC operating bus section is typically protected by summation overcurrent or bus differential relaying; this relaying trips and blocks closing of the IC's transformer FIDs.

Although not part of the Point of Contact protection, these protection schemes will be reviewed by PPL EU since operation of these relays blocks automatic load transfer and closing of the 12 kV FIDs.

12.3.3.5 Other IC Protective Relays

Additional protective relaying can be applied as required to protect IC equipment including the operating bus and transformers. These IC-specified relays can initiate a trip of the IC's low side FID but are not considered POC relaying. These additional IC relays shall be connected to separate CTs; they may not be connected to the CTs used for POC protective relays.

PPL EU may comment on this additional IC relaying, but relay settings are neither specified nor applied by PPL EU.

If master trip relays are used to open the POC FID, separate master trip relays will be applied for the POC protection and the IC's additional protection; these two separate relay packages will not share a common master trip relay.

12.3.3.6 Automatic Reclosing

Single shot automatic reclosing can be applied to the transformer low side FIDs. Initiating an automatic reclose, if provided, shall only occur after supply line faults. Automatic reclosing shall be blocked after transformer and operating bus faults. POC/IPR relaying shall not be used to initiate automatic reclosing.

The control logic associated with the transformer low side FIDs will be reviewed by PPL EU.

12.3.3.7 POC Protection Requirements

The following are the POC protection requirements for the two-line supply (Type AA) substation:

Current Transformers

The IC's source FID shall be equipped with three multi-ratio current transformers (one per phase) for supply to the POC relays. These current transformers shall be located on the outer-most position of the PPL EU supply line side of the FID bushings. If the IC is using differential protection, they may choose, with PPL approval, to utilize the outermost CT for the differential protection. All tap connections of the multi-ratio CTs shall be wired out to terminal blocks and be accessible for future CT tap changes.



The POC CTs shall have a relaying accuracy class of C200 or better and be set on a tap such that the maximum available short circuit current does not produce saturation. The IC shall provide CT saturation study results to PPL EU.

The POC CTs shall have a voltage rating equal to the FID that they are mounted on or are associated with and shall meet the BIL insulation ratings as specified in Section 9.6.

These CTs shall not be used as supply to the billing metering equipment, nor any other IC protection or monitoring functions. If additional protection or monitoring functions are desired for the IC's use, additional CTs shall be supplied suitable for the IC's applications. Current transformers for the IC's non-POC use will be located on the inside of the CTs assigned for POC protection; in other words, the PPL EU POC CTs shall be located in the outer-most position on the PPL EU supply line side of the POC FID bushings.

PPL EU will review CT tap settings proposed by the IC or, if requested, will specify the CT tap settings. PPL EU will supply fault current data at the point of the IC's connection to facilitate the proper sizing of the CTs.

Potential Transformers

The ICs shall have three single phase, wye-connected, relaying class accuracy potential transformers connected on the load side of each power transformer.

These potential transformers shall be able to support the connected relay burden during normal operation and system fault conditions. These potential transformers shall not be used as supply to the billing metering equipment, station service loads, nor any other IC protection or monitoring functions. If additional protection or monitoring functions are desired for the IC's use, the potential transformers shall be supplied with dual secondary windings—one secondary winding shall be reserved for PPL EU Point of Contact protection functions.

PPL EU Supply Line Fault Protection

Since the supply lines are not paralleled through the IC's equipment, supply line faults are cleared remotely by PPL EU. This action isolates the fault and the entire IC load is then supplied by the remaining supply line after the IC's operating bus sectionalizing FID closes.

Power Transformer Fault Protection

Transformer Fuses

At IC substations with 69 kV service where fuses are installed, the IC shall provide 69 kV fuses which will be S&C Company type SMD2B (SMD-3C units can sometimes be used if a larger interrupting rating is required—but the IC shall discuss with PPL EU before changing from the standard SMD-2B). The fuse interrupting rating, link size and characteristics shall be approved by PPL EU. The 69 kV POC fuses provide clearing for faults in the IC's equipment.

Over-current Relays

Three phase (inverse) and one ground (very inverse) relays with time and instantaneous over-current elements connected to CTs connected on the PPL EU supply line side of each 69 kV or 138 kV FID are required to detect faults in the transformers. This relaying shall trip the PPL EU-side POC FID.

PPL EU will approve the relay ranges and settings for these POC relays. The instantaneous attachments of either or both phase and ground relays may be blocked from operation by PPL EU.

See **Attachment C – PPL Pre-approved POC/IPR**. If a relay is not included in this list, it is not acceptable for POC duty.

IC Operating Bus

At 69 kV or 138 kV supply voltages, IC substation 12 kV bus summation or bus differential protection is required for proper operation of the 12 kV bus transfer scheme. PPL EU will review this protection but will not provide relay settings or calibration of the relays.

Under-voltage Relays

Each 69 kV or 138 kV source shall be provided with three under-voltage relays, connected to the 12 kV potential transformers on the load side of each power transformer, to monitor the source line voltage.

These under-voltage relays supervise the automatic transfer and automatic restoration during the loss of the 69 kV or 138 kV source. PPL EU will review this protection but will not provide relay settings or calibration of these under-voltage relays.

Automatic Transfer Scheme

Automatic Transfer Upon Loss of a 69 kV or 138 kV Source

A hard-wired interlock shall be provided to ensure that when an automatic transfer is initiated, the lost source FID is open before closing the bus sectionalizing FID.

Loss of the 69 kV or 138 kV line shall be detected by under-voltage relays.

Loss of potential on a single phase shall initiate automatic transfer.

All transfers are normally initiated with a minimum 2.0 second time delay. This assures that the opposite source is energized before load transfer and that this transfer does not occur during transient system fault conditions.

Transfers shall not be initiated for a loss of potential resulting from faults in the IC's equipment. The IC's bus protective relays will operate a hand-reset lockout relay, which will trip the associated transformer 12 kV FID and block automatic transfer.

Automatic Return to Normal Operation

The IC has the option to include in the control scheme the automatic return to normal operation feature. If the IC chooses this option, the scheme shall include the following design criteria:

- A hard-wired interlock shall be provided to ensure that the bus sectionalizing FID is tripped before closing the restored source.
- Automatic return to normal operation is initiated only after a three-phase potential check of the restored line.
- Under-voltage relays for 69 kV or 138 kV supply lines initiate the automatic return to normal operation.
- The return shall be initiated with a minimum three-minute time delay setting being specified by PPL EU. The transformer low side FID of the restored source is closed after the bus sectionalizing FID is tripped.
- Automatic unsupervised momentary paralleling of the two source lines is not permitted.

Manual Transfer

The selected source FID shall be tripped before the 12 kV bus sectionalizing FID can be closed.

Manual Return to Normal Operation

During manual return to normal operation, the IC shall not at any time close all three FIDs simultaneously. Hard wired interlocks shall be provided to prevent any paralleling of the two source lines. The following sequence shall be followed to manually return the substation to normal operation:

- Visual three-phase potential check (consisting of indicating lights or voltmeter) on the restored line.
- Trip the bus sectionalizing FID by control switch.
- Close the respective source FID by control switch.
- Provision to manually momentarily parallel the two sources with prior approval from PPL EU.

The IC under direction of the PPL EU Transmission Operator can manually close both transformers' low side FIDs and the bus sectionalizing FID for a very short period (only long enough to permit the manual operations to take place). This will permit a load transfer back to either source without dropping load. Prior approval for this type of operation (momentary paralleling of sources) shall be obtained from PPL EU.

During this operating mode, hard-wired interlocks shall be provided to automatically trip one of the FIDs within a maximum of one second after the three FIDs are closed.

12.3.3.8 POC Control Requirements

Manual Control

Each 12 kV, 69 kV, or 138 kV FID (other than fuses) shall be equipped with a control switch to manually operate the FID.

POC protective devices shall be hard-wired to trip the POC FID. POC relay trip contacts will not trip the POC FID via any type of intermediate microprocessor.

A three-position transfer selector switch shall be provided to select automatic or manual operation of the 12 kV FIDs.

A two-position switch "NORMAL-PARALLEL" with a padlock hasp in the "NORMAL" position shall be provided to allow PPL EU to momentarily parallel the two sources.

Automatic Control

Automatic reclosing of 69 kV or 138 kV FIDs is not permitted; this is to prevent automatic reclosing on faulted equipment.

An automatic transfer scheme will include the following:

- Each transformer low side FID shall be equipped with a timing scheme to allow a single reclosure attempt when the FID is open and there is potential on the source side of the FID.
- The bus sectionalizing FID shall be equipped with a timing scheme to allow a single reclosure attempt. The bus sectionalizing FID closes when either line FID has tripped on loss of potential and the opposite line is energized.

Indication

The closed position of each FID shall be monitored with a red indicating light.

The open position of each FID shall be monitored with a green indicating light.

Each FID trip coil shall be monitored either by a yellow light or by a red indicating light in series with an FID trip coil and an FID "a" auxiliary contact. A "TCM" (trip coil monitor) is also acceptable. If the FID uses a capacitor trip device, the FID trip coil shall be monitored by a yellow light in series with a pushbutton. This will allow a manual test of the FID trip coil continuity without placing a constant current drain on the capacitor charge.

The trip coils of master trip relays shall be monitored with yellow indicating lights.

Power to control circuits for POC relaying, master trip relay circuits, and the FID control circuit shall be supplied via separate fuses. Each fuse shall be monitored for blown fuse or open circuit conditions with a yellow indicating light or annunciator.

Three-phase AC potential of each line shall be monitored with white indicating lights.

Annunciator alarms shall be indicated or displayed in a location which is normally manned, so that any change of annunciator status is promptly noticed.



Test Facilities

POC relays shall be provided with isolation facilities so that all current and potential (if provided) inputs and trip contacts are wired through test points. If not provided by the manufacturer in the form of a draw-out relay case, additional test switches such as the ABB FT1 (or equivalent) shall be provided by the IC.

POC Commissioning

For the initial commissioning of an IC's facility, the POC relays will be set and tested by PPL EU personnel. PPL EU will also test the CTs (and VTs, if required) which supply the POC relays. Testing will include a full functional test, including tripping of the POC FID device.

IC Protection Schemes

The IC may supply protective relays in addition to the required POC relays, at the IC's discretion. These additional relays will be supplied from CTs and VTs separate from the ones used to supply the POC relays. These additional relays will be set at the IC's discretion. If the settings are provided to PPL EU, an attempt will be made to set the POC relays to coordinate with the IC's relays, but PPL EU cannot guarantee optimum coordination.

12.3.3.9 Type AA Single Line Diagram

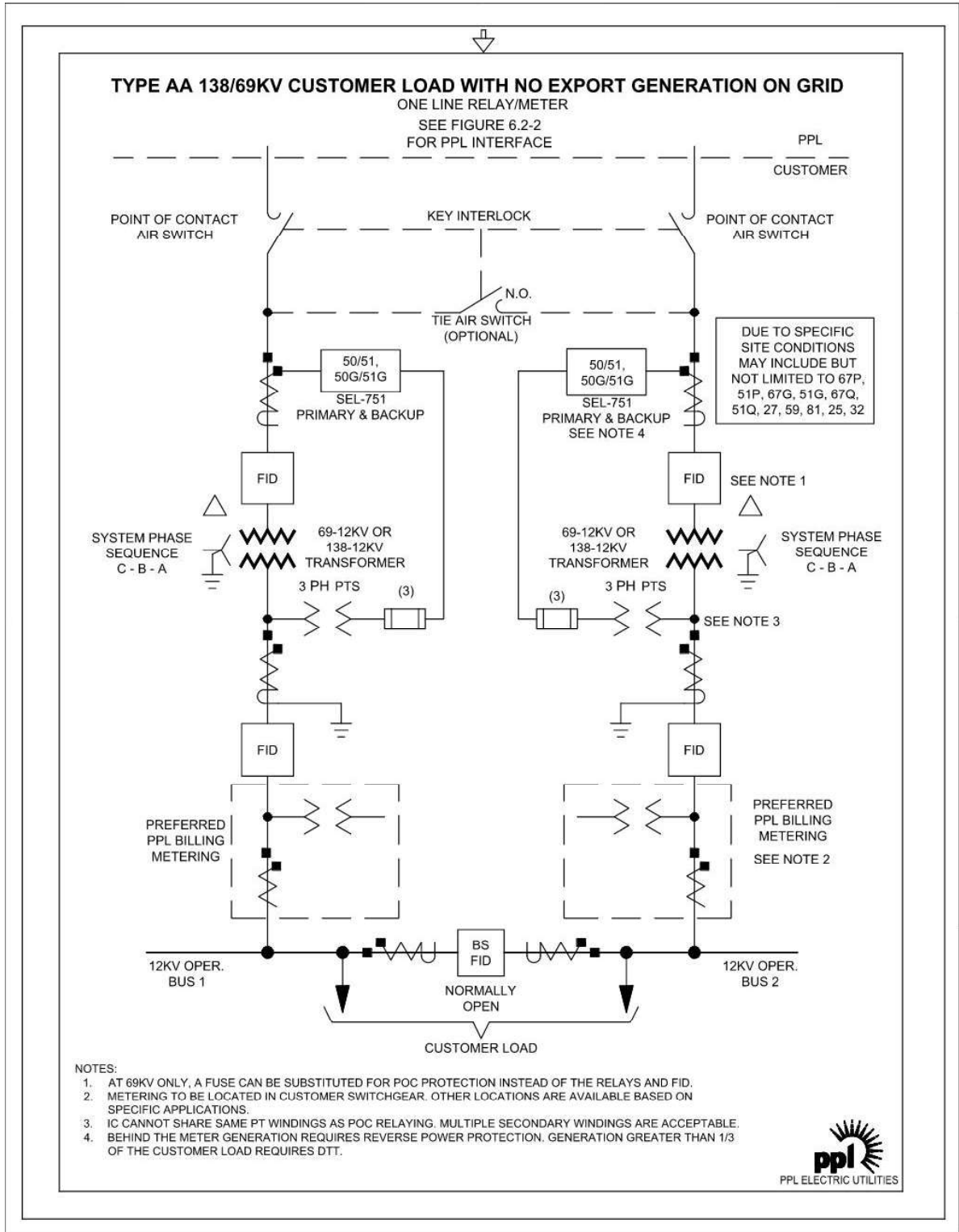

Figure 12.3.3.9-1 – Type "AA" Customer Configuration

12.3.4 Two Line Supply Substation - Closed Tie Between Sources (Type B)

12.3.4.1 Substation Configuration and Operating Philosophy

The two-line supply (Type B) configuration provides service to the IC via two independent lines of supply. During normal operation as discussed below, the supply lines are paralleled via the IC facility operating bus.

The advantage of this configuration is that the IC load will not be interrupted following the loss of a PPL EU supply line or an IC's single power transformer.

At 69 kV and 138 kV supply voltages, a power transformer is typically installed on each PPL EU line of supply; the parallel between the two supplies is made on the low side of the power transformers via a tie on the IC's bus.

FIDs, such as fuses (applicable only for 69 kV installations) or circuit breakers or equivalents, are installed on the power transformer high voltage side. FIDs such as circuit breakers or the equivalent are installed between each power transformer low side and the IC operating bus.

Note that if fuses are installed for the POC FID, microprocessor relays will still be required to isolate the low side circuit breakers in the event of a transmission fault.

Note that 69 kV fuses are only allowed for POC protection at IC installations without generation. If the IC adds generation at some future time, the IC will be responsible to replace the 69 kV fuses with 69 kV circuit breakers and related protective relays, at the IC's expense

The operating bus is sectionalized with an FID other than a fuse or manually operated disconnects.

12.3.4.2 Normal Operation

Under normal operating conditions, the bus sectionalizing FID is closed, both transformer low side FIDs are closed, and both power transformers are energized and carrying load.

12.3.4.3 Operation Under Fault Conditions

PPL EU Supply Line Faults

Since the PPL EU supply lines are paralleled through the IC's equipment, directional relaying or over-voltage/under-voltage relays will initiate tripping of the transformer low side FID associated with the faulted supply line. This action isolates the fault, and the entire IC load is then supplied by the remaining PPL EU supply line.

Power Transformer Faults

At 69 kV IC substations where a high side fuse is the point of contact protection, a faulted transformer is isolated by blown fuses, and the low side is isolated by opening the FIDs with over/under voltage relaying and/or low side directional relaying schemes.

If a circuit breaker or other relay-supervised device is the FID, then a faulted power transformer will be isolated on the high and low voltage sides by the operation of protective high side over-current relays.

Either of the above actions will isolate the faulted power transformer and isolate the IC operating bus from the fault. The entire IC's load is then supplied by the remaining PPL EU line.

12.3.4.4 IC Operating Bus

Each IC operating bus section is typically protected by summation over current or bus differential relaying. This relaying trips and blocks closing of the IC's transformer low side FIDs.

Although not part of the Point of Contact protection, these protection schemes will be reviewed by PPL EU since operation of these relays opens the PPL EU Transmission System supply line parallel.

12.3.4.5 Other IC Protective Relays

Additional protective relaying can be applied as required to protect IC equipment including the operating bus and transformers. These IC-specified relays can initiate a trip of the IC's low side FID but are not considered POC relaying. These additional IC relays shall be connected to separate CTs; they may not be connected to the CTs used for POC protective relays.

PPL EU may comment on this additional IC-specified relaying, but relay settings are neither specified nor applied by PPL EU.

If master trip relays are used to open the POC FID, separate master trip relays will be applied for the POC protection and the IC's additional protection; these two separate relay packages shall not share a common master trip relay.

12.3.4.6 Automatic Reclosing

The IC has the option to include in the control scheme automatic reclosing of the low side transformer FIDs. If the IC chooses this option, the scheme shall include the following design criteria:

- A single shot reclosing relay shall be provided.
- A control switch trip of the FID shall block automatic reclosing.
- Automatic reclosing of a low side transformer FID shall be blocked following a trip for an operating bus fault.
- Automatic reclosing of a low side transformer FID shall be blocked following a trip for a transformer fault.
- Automatic reclosing blocking switches shall be provided.
- A potential check of the 69 kV or 138 kV line is required. This potential will be supplied to a potential-check timing relay. Interlocking the potential to the relay with a "b" form auxiliary contact from the transformer FID or from the 12 kV utility line FID is required.

- An automatic reclose attempt shall be initiated after a minimum time delay following the restoration of the 69 kV or 138 kV source. The time delay will be specified by PPL EU.

POC/IPR Relaying shall not be used to initiate automatic reclosing.

The control logic associated with the transformer low side FIDs will be reviewed by PPL EU.

12.3.4.7 POC Protection Requirements

The following are the POC relaying requirements for two-line supply (Type B) Substations:

Current Transformers

The IC's source 69 kV or 138 kV FIDs and the IC's 12 kV transformer FIDs shall each be equipped with three multi-ratio current transformers (one per phase) to supply the POC relays.

These CTs shall be located on the outer-most position of the PPL EU supply line side of the 69 kV or 138 kV FID bushings, and a separate set of CTs located on the operating bus side of the IC's 12 kV transformer FID. If the IC is using differential protection, they may choose, with PPL approval, to utilize the outermost CT for the differential protection. All tap connections of the multi-ratio CTs shall be wired out to terminal blocks and be accessible for future CT tap changes.

The POC current transformers shall have a relaying accuracy class of C200 or better and be set on a tap such that the maximum available short circuit current does not produce saturation. The IC shall provide CT saturation study results to PPL EU.

The POC CTs shall have a voltage rating equal to the FID that they are mounted on or are associated with and shall meet the BIL insulation ratings as specified in Section 9.6.

These CTs shall not be used as supply to the billing metering equipment, nor any other IC protection or monitoring functions. If additional protection or monitoring functions are desired for the IC's use, additional CTs shall be supplied suitable for the IC's applications. Current transformers in the 69 kV or 138 kV FIDs for the IC's non-POC use will be located on the inside or IC side of the CTs assigned for POC protection; in other words, the PPL EU POC CTs shall be located in the outer-most position on the PPL EU supply line side of the 69 kV or 138 kV POC FID bushings.

PPL EU will review CT tap settings proposed by the IC or, if requested, will specify the CT tap settings. PPL EU will supply fault current data at the point of the IC's connection to facilitate the proper sizing of the CTs.

Potential Transformers

The IC will provide three (3) single phase, wye connected, relaying class accuracy, 7200/120 volt-rated potential transformers on the operating bus to supply protective relays specified as POC.

When automatic reclosing of the 12 kV transformer FIDs is included in the IC's design, a single-phase potential transformer is required on the transformer side of each 12 kV transformer FID.

These potential transformers shall not be used as supply to the billing metering equipment, nor any other IC protection or monitoring functions. If additional protection or monitoring functions are desired for the IC's use, the potential transformers shall be supplied with dual secondary windings—one secondary winding shall be reserved for PPL EU Point of Contact protection facilities. No station service loads such as lights, heaters, etc. shall be connected to these potential transformers.

These potential transformers shall be able to support the connected relay burden during normal operation and system fault conditions.

Potential Devices

The IC shall provide a single-phase capacitive coupling potential device or resistive potential device on each 69 kV or 138 kV supply line to provide potential to over-voltage/under-voltage POC relays.

Similarly, these potential devices shall not be used as supply to the billing metering equipment, station service loads, nor any other IC protection or monitoring functions. If additional protection or monitoring functions are desired for the IC's use, the potential devices shall be supplied with dual secondary windings—one secondary winding shall be reserved for PPL EU Point of Contact protection facilities.

PPL EU Supply Line Fault Protection

Over-voltage/Under-voltage Relays

Over-voltage/under-voltage relays are required to protect for phase-to-ground faults on the PPL EU supply lines since 69-12 kV or 138-12 kV power transformers are required with delta-connected windings on the high voltage side and wye-connected windings on the low voltage side.

Following remote terminal clearing for a phase-to-ground fault on a 69 kV or 138 kV supply line, tripping of the related low side transformer FID at the IC's substation is required to eliminate back-feeding a 69 kV or 138 kV line through the IC's equipment.

A relay scheme which can detect this condition requires a single 69 kV or 138 kV potential device connected to one phase to ground on each supply line. Under-voltage and over-voltage relays shall be connected on the secondary of each potential device and will operate a timing relay to trip the low side transformer FID associated with the faulted supply line.

Directional Relaying

Because the PPL EU supply lines are paralleled through the IC's equipment, directional relaying is required to initiate tripping of the transformer FID associated with a faulted supply line.

For 69 kV or 138 kV PPL EU supply lines, a balanced power relay scheme is recommended.

Balanced Power

Potential to the directional relays shall be supplied from the 12 kV operating bus potential transformers. A balanced current connection shall be used, i.e., for equal current flow into the operating bus through each 69 kV or 138 kV transformer, the secondary currents at the directional relays shall sum to zero.

The potential and current connections shall be made such that the throw of the relay will enable a trip of the low side transformer FID on the faulted supply line.

One set of balanced power relays shall consist of two polyphase direction relays and three phase time over-current relays with very inverse characteristics and instantaneous attachments. A poly-phase directional relay with watt characteristic shall be supervised by the very inverse time over-current relays, and a poly-phase directional relay with a 60-degree maximum torque angle shall be supervised by the instantaneous attachments.

TOC elements of the over-current relays shall be torque controlled with supervision provided by low side transformer FID status.

A two-position "Balanced Power Blocking Switch" shall be provided.

Auxiliary contacts from the main 12 kV FIDs shall be incorporated in the balanced power control logic:

- To provide a seal-in of the trip output until a main FID opens, and
- To block the operation of the scheme with one main FID open.

Operating in Type B Configuration

Prior to paralleling the two PPL EU supply lines through the operating bus, the Balanced Power Blocking Switch or the Power Directional Blocking Switch shall be in the "IN" position. After this switch move is made, both FIDs can be closed.

If directional relaying is unavailable, the 69 kV or 138 kV lines shall not be paralleled. One method of operation to keep both supply lines in service would be to split the 12 kV operating bus by opening the 12 kV bus section FID or bus sectionalizing disconnects.

12.3.4.8 Power Transformer Fault Protection

Transformer Fuses

At IC's substations with 69 kV service where fuses are installed, the IC shall provide each transformer with 69 kV fuses—S&C Company type SMD-2B (SMD-3C units can sometimes be used if a larger interrupting rating is required—but the IC shall discuss with PPL EU before changing from the standard SMD-2B). The fuse interrupting rating, link size, and characteristics shall be approved by PPL EU.

The 69 kV POC fuses will provide clearing for faults on the IC's equipment.

Over-current Relays

Three phase (inverse) and one ground (very inverse) relays with time and instantaneous over-current elements connected to CTs connected on the PPL EU supply line side of each 69 kV or 138 kV FID are required to detect faults in the transformers. This relaying shall trip the PPL EU-side 69 kV or 138 kV POC FID.

PPL EU will approve the relay ranges and settings for these POC relays. The instantaneous attachments of either or both phase and ground relays may be blocked from operation by PPL EU.

See **Attachment C – PPL Pre-approved POC/IPR Equipment**. This list will be provided to the IC upon request. If a relay is not included in this list, it is not acceptable for POC duty.

12.3.4.9 IC Operating Bus

Bus differential protection for the low voltage operating bus at 69 kV or 138 kV substations is not considered to be POC protection; however, the IC shall consider adding bus differential for fast clearing of bus faults.

PPL EU will review this protection but will not provide relay settings or calibration of these relays.

12.3.4.10 POC Control Requirements

Manual Control

- Each 12 kV, 69 kV, or 138 kV FID (other than fuses) shall be equipped with a control switch to manually operate the FID.
- POC protective devices shall be hard-wired to trip the POC FID. POC relay trip contacts shall not trip the POC FID via any type of intermediate microprocessor.
- Schemes which are designed for manual reclosing of the 12 kV transformer FID upon restoration of the 69 kV or 138 kV supply line do not require contact with the PPL EU Transmission Operator prior to a manual close attempt; however, indication of normal supply line potential shall be present prior to the reclose attempt.
- A manual reclose of the 12 kV bus sectionalizing breaker does not require contact with the regional PPL EU Transmission Operator prior to the reclose attempt.
- If bus differential protection is provided, a bus differential lockout relay contact shall be provided to block manual closing of the 12 kV transformer FIDs. The lockout relay shall be reset to allow a manual close of the 12 kV transformer FID.
- If transformer differential protection is provided, a transformer differential lockout relay contact shall be provided to block manual closing of the related low side transformer FID and the 69 kV or 138 kV FID. The lockout relay shall be reset to allow a manual close of either FID.

Automatic Control

Automatic reclosing of the 69 kV or 138 kV FIDs is not permitted; this requirement is to prevent automatic reclosing on faulted equipment. See **Section 12.3.4.6** for reclosing requirements of transformer low side circuit breaker.

Indication

- The closed position of each FID shall be monitored with a red indicating light.
- The open position of each FID shall be monitored with a green indicating light.
- Each breaker trip coil shall be monitored either by a yellow light or by a red indicating light in series with an FID trip coil and an FID "a" auxiliary contact. A "TCM" (trip coil monitor) is also acceptable. If the FID uses a capacitor trip device, the FID trip coil shall be monitored by a yellow light in series with a pushbutton. This will allow a manual test of the FID trip coil continuity without placing a constant current drain on the capacitor charge.
- The trip coils of master trip relays shall be monitored with yellow indicating lights.
- Power to control circuits for POC relaying, master trip relay circuits, and the FID control circuit shall be supplied via separate fuses. Each fuse shall be monitored for blown fuse or open circuit conditions with a yellow indicating light or annunciator alarm.
- Annunciator alarms shall be indicated or displayed in a location which is normally manned, so that any change of annunciator status is promptly noticed.
- Three-phase AC potential from each line used for POC relaying shall be monitored with white indicating lights.
- Transformer low side AC potential shall be monitored with a white indicating light.

Test Facilities

POC relays shall be provided with isolation facilities so that all current and potential (if provided) inputs and trip contacts are wired through test points. If not provided by the manufacturer in the form of a draw-out relay case, additional test switches such as the ABB FT1 (or equivalent) shall be provided by the IC.

POC Commissioning

For the initial commissioning of an IC's facility, the POC relays will be set and tested by PPL EU personnel; PPL EU will also test the CTs (and VTs, if required) which supply the POC relays. Testing will include a full functional test, including tripping of the POC FID device.

IC Protection Schemes

The IC may supply protective relays in addition to the required POC relays, at the IC's discretion. These additional relays will be supplied from CTs and VTs separate from the ones used to supply the POC relays. These additional relays will be set at the IC's discretion. If the settings are provided to PPL EU, an attempt will be made to set the POC relays to coordinate with the IC's relays, but PPL EU cannot guarantee optimum coordination.

12.3.4.11 Type B Single Line Diagram

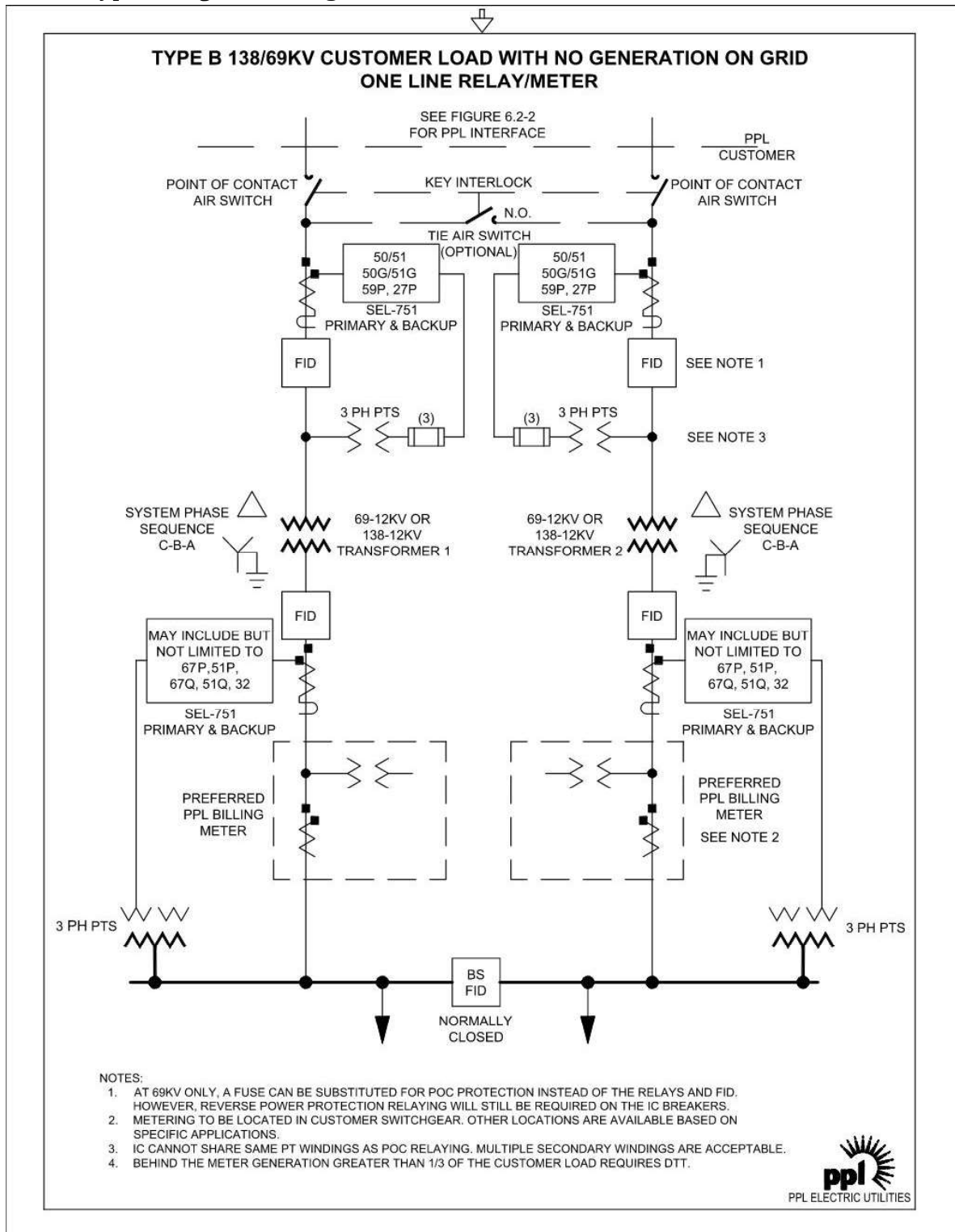

Figure 12.3.4.11-1 – Type "B" Customer Configuration

12.4 Generation Requirements

12.4.1 Scope

The scope of this section is limited to the Protective Relaying and controls for the PPL EU protection of the Generation Facilities. All material and instrumentation shall conform with **Sections 12.1, 12.2, 12.3**. See Section **12.1** for a discussion of the philosophy of POC and IPR protection packages—every customer with generation will require both POC and IPR protection.

The relay cabinet or panel will contain all relays and controls specified by PPL EU for a particular interconnection, with the exception of the Out-of-Step and Synch-Check protection schemes, which may be applied on a per generator basis for multiple generator interconnections.

The protection equipment is installed to protect the PPL EU Transmission System from adverse effects of the generation; for this reason, *control* of this equipment and the associated settings are to remain with PPL EU. PPL EU personnel shall always be allowed access to this equipment.

If there is substantial distance or other equipment between the generation equipment and PPL EU, it may be necessary to have the sensing CTs and VTs located at the point of common coupling (PCC). Also, in this case, the generation operator may desire to have the relaying operate a breaker other than the generation breaker. When the CTs, VTs, or controlled breaker are remote from the IEEE 1547 compliant equipment, then the protection and drawings requirements below need to be met.

All relays will use phase-to-neutral potential (67-volt taps) and phase-current (from WYE connected CTs). Proper phasing and polarities shall be followed as indicated in manufacturers' instruction books. ALL relays are to be connected according to PPL EU phase designations.

All relays shall incorporate isolation devices (i.e., test switches), to isolate all inputs and all outputs of the IPR relaying for testing.

See **Attachment C – PPL Pre-approved POC/IPR Equipment** for a list of currently approved relays and isolation switches.

12.4.2 Specific Protection Scheme Components

12.4.2.1 Background

The functional characteristics designed into protection schemes for Generation Facilities being connected to the existing PPL EU Transmission System are:

- Fast operation by under-voltage protection to disconnect the IC's facility for a supply line fault or isolation prior to the first instantaneous reclosure. This is required to prevent the generation from possibly sustaining the fault and thus causing the line test from the PPL EU remote terminal to be unsuccessful or to minimize the chance of an out-of-phase reclosure.
- Fast operation on overvoltage protection if overexcitation and/or ferro-resonance cause a rapid, severe voltage rise.

The interconnection relay systems shall have the capability to withstand electromagnetic interference (EMI) environments (as per IEEE Std. C37.90.2-latest version) so that the influence of EMI shall not result in a change of state or mis-operation of the interconnection system.

A simple, reliable, fail-safe system is considered important. The main emphasis is to assure disconnection on loss of the PPL EU source line. It is desired that tripping be initiated as directly as possible from the measured supply voltage with minimum reliance on interspersed devices. An AC-powered, non-latching contactor is a suitable device.

NOTE: Under no circumstances are the relays to trip through a PLC (programmable logic controller) or other programmable device. The relays shall trip directly to avoid any additional time delay for an interposing programmable device. Auxiliary relays can be used only if absolutely necessary. The trip signal may be monitored by a PLC or other programmable device to facilitate control functions at the IC facility.

12.4.2.2 Relay Protection – Basic Package

The Protective Relays are intended to provide the same functionality as defined in IEEE 1547, the latest version.

Interconnected Generation Facilities can have an appreciable impact on system voltage levels. Also, with more sophisticated controls it is more probable that larger units (i.e. 500 and 230 kV connected generators and units approaching the minimum load of units connected at 69 and 138 kV) may continue operating if isolated with a portion of the PPL EU Transmission System. There is a need for a precise reactive power or voltage schedule and for a control system which prevents excessive deviation from the developed voltage schedule.

Obtaining selectivity, to prevent false trips, for system faults not on the PPL EU source line takes on greater importance. Unnecessary tripping of these larger units can have a negative impact on the PPL EU Transmission System. High speed reclosing typically will not be used on these supply lines.

Larger units can impact a significant portion of the PPL EU Transmission System, and therefore, a high assurance is required to clear the generator for trips of the PPL EU supply line to which it is connected.

The protective relays shall also include primary and backup line protection functions. Specific relays and type of line protection will be specified at the time of project evaluation and will depend on the voltage of the desired interconnection and the types of line protection already on the line and/or the applicable PPL EU standards.

A typical >200kV installation is shown in **Figure A12.4.2-1**. A typical <200kV installation is shown in **Figure A12.4.2-2**.

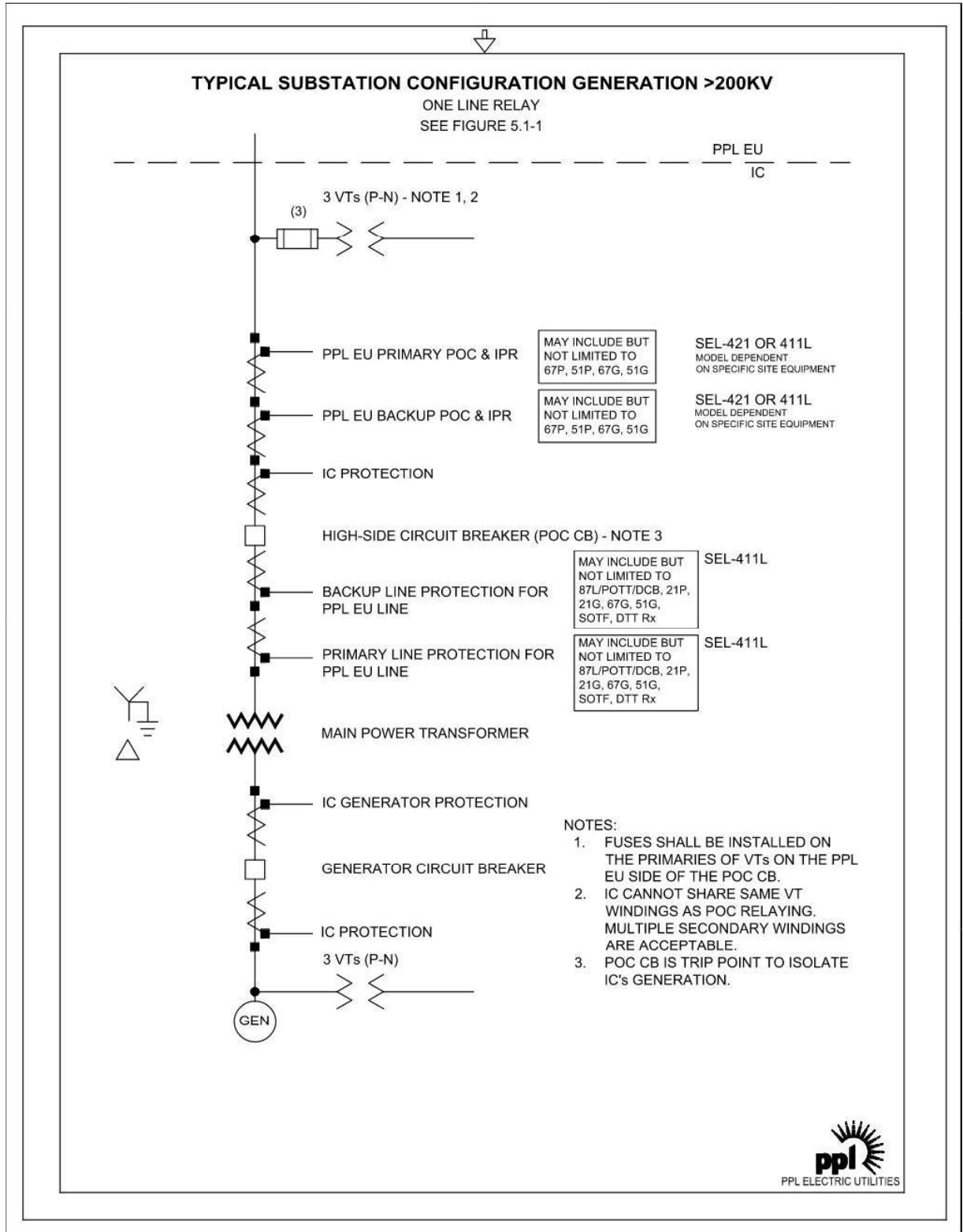

Figure 12.4.2.-1 Typical IC Generation Installation >200kV

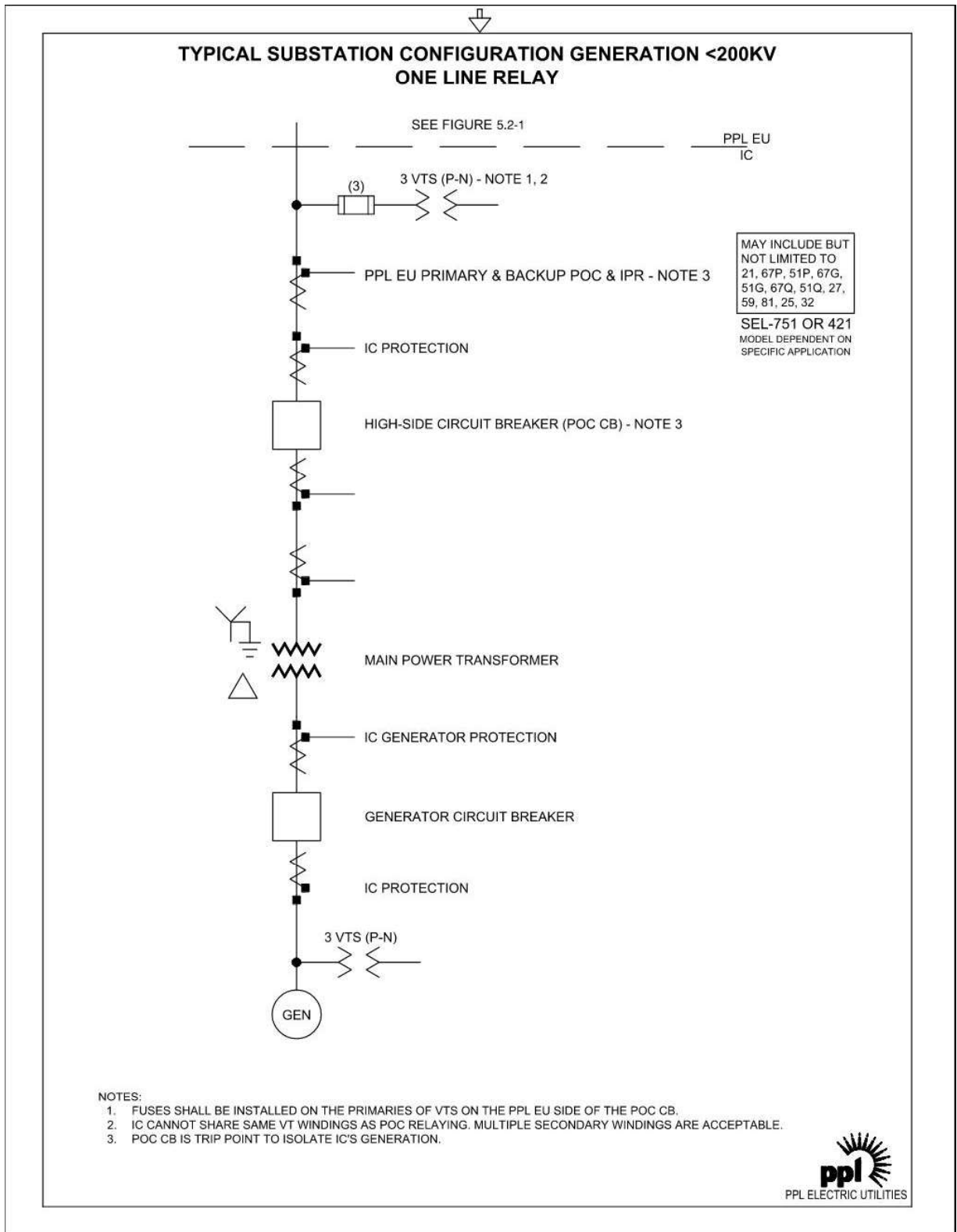

Figure 12.4.2.-2 Typical IC Generation Installation <200kV

12.4.3 Generator Types--Protection and Control Requirements

Synchronous Generators

Synchronous generation facilities will require a dedicated Parallel Generation protection.

Induction Generators

Induction generation facilities will require a dedicated Parallel Generation protection.

If a capacitor is used to serve as the excitation source for an induction generator, the capacitor shall not be capable of remaining on the system with the generator off-line.

Inverter-based Interconnections

Inverter based installations using UL 1741 listed inverters will not be required to provide an additional disconnect switch at the meter location. NOTE: there may be other disconnect switches required by NEC or local electrical inspection requirements.

Below is a list of items that may need to be addressed depending on the specific application.

Inverters convert DC power to AC by means of electronic switching. Switching can be controlled by the AC voltage of the supply system (line-commutated) or by internal electronic circuitry (forced-commutated), or the type PWM (Pulse Width Modulation). Line-commutated inverters are generally not capable of operating independently of the AC supply system and, as such, cannot supply fault current or isolated loads. Forced-commutated and PWM inverters are capable of supplying fault current and may supply load independent of the AC supply system. All inverters will be expected to conform to the ANSI/IEEE 1547 Standard for Interconnecting Distributed Resources with Electric PPL EU Transmission Systems (latest version) and UL Publication 1741-Inverters, Converters, Controllers and Interconnection System Equipment for Use With Distributed Energy Resources (latest version).

Equipment like Solar arrays (photovoltaic), certain wind turbines, and microturbines, for example, generate their power at DC or high frequency AC and use inverters to convert this power to 60 Hz AC at a suitable voltage level.

Units below 10 kW, which are in compliance with IEEE 1547, and UL-1741, can be connected to the PPL EU Transmission System without any other additional protection.

Facilities rated 10 kW up to 2 MW, or locations using multiple inverters will be subject to PPL EU review, and may require additional external protection equipment.

The IEEE 1547 standard is primarily intended to be applied at the Area Electric PPL EU Transmission System (EPS) or the utility DISTRIBUTION system, see IEEE 1547, section 1.3 limitations. Further, ALL of the requirements of this standard are to be met at the PCC (Point of Common Coupling), which on the PPL EU Transmission System is typically the 12.47 kV, 69 kV, or 138 kV connection to the IC's equipment, see IEEE 1547, section 1.2 Purpose, second paragraph.

12.4.3.1 Generation Information Requirements

With the above background information, the following items need to be discussed on all IPR projects:

- These facilities will be required to have both POC (Point of Contact) protection and IPR (Intertie Protection Relay) protection. PPL EU requires the use of a three-phase circuit breaker as the fault interrupting device for all IC installations with generation.
- The IEEE 1547.1 tests and the UL 1741 tests only test the operation of the inverter at THE TERMINALS OF THE INVERTER. However, the application of LARGE PV requires the use of one or more transformers to get from the low voltage inverter output (120 to 600 VAC) to the utility 69 kV or 138 kV supply voltage level. The inverters may not correctly control or maintain the required settings at the PCC as they do not have a direct connection (sensors, CTs, or VTs) to the PCC. See IEEE 1547, section 1.2, second paragraph, which states “The requirements shall be met at the point of common coupling (PCC), although the devices used to meet these requirements can be located elsewhere.” Per IEEE 1547.1 Testing Requirements, section 5.2 “If the EUT senses voltage at a different point than the PCC with the area EPS or at the point of DR connection as specified in IEEE Std 1547, it shall be tested under load in conjunction with any external isolation transformer supplied or required by the EUT manufacturer.” The IC or the inverter vendor needs to provide additional information on this item.
- The IC or the inverter vendor is requested to supply a copy of the UL1741 test report as well as any documentation of the effects or interactions of multiple units operating in parallel on the IEEE settings and operating times.
- The IC or the inverter vendor will need to comment on the capability of the proposed equipment to REGULATE the power factor of the overall facility as measured at the POI per PPL EU requirements. The equipment will need to be able to adjust the var flow with respect to the real power level. Also, since these facilities are typically LINE connected, they will typically be required to ABSORB vars to maintain the correct line voltage at the PCC. While IEEE 1547 section 4.1.1 states “The DR shall not actively regulate at the PCC. The DR shall not cause the area EPS service voltage at other local EPS’s to go outside the requirements of ANSI C84.1-1995, range A.”, the second sentence will typically be the requirement for LINE connected facilities.
- The IC shall supply full electrical specifications for all electrical equipment included in the POC and IPR requirements (as well as inverters), including but not limited to the fault current levels and duration.
- PPL EU employs automatic reclosing on its facilities. The initial reclosure is typically delayed 1.5 seconds. Reclosing times are much faster than the IEEE 1547 anti-island settings of 2 seconds. The IC or the inverter vendor shall provide data or other information on the potential out-of-phase reclosing that could exist with other IC’s rotating equipment connected to this area EPS. PPL EU will typically modify its facilities to include synch-check relaying to avoid out-of-phase reclosing.

- The inverter installation shall be designed such that an interruption to the PPL EU supply line will result in the disconnection of the inverter to the supply system. Since this feature is normally included in the inverter interface, additional Intertie Protective Relaying will not be required for certified systems of 10 kVA or less. This equipment is required to conform to IEEE Standard 1547, latest version, and UL Publication 1741, latest version. In order to verify conformance with this requirement, PPL EU shall be provided with sufficient information on the interface package. Harmonics and distortion of the voltage or current, generated by the generator-inverter combination, shall not exceed PPL EU harmonic distortion requirements, as per IEEE Std. 519, latest version. Under no circumstances will these installations be allowed to inject DC current above the IEEE 1547 limits into the PPL EU Transmission System.
- Generation equipment certified to IEEE 1547 will provide sufficient protection for most installations. Occasionally the generation will have such a large impact that the PPL EU equipment cannot be coordinated with the generation facility, or the generation facility can support operation as an island. Under these circumstances, additional protection beyond that specified in IEEE 1547 in the form of DTT or voltage block closing, or both may be required.

12.4.3.2 POC and IPR Requirements

With the above background information, the following items shall be provided and discussed early in the design process on all POC/IPR projects:

- The IC shall provide a one line with sufficient detail to show all transformer connections, and the location and connection of all equipment.
- The IC facilities will be required to have primary and backup POC (Point of Contact) / IPR (Intertie Protection Relay) protection. PPL EU requires that relay packages be provided, i.e. Primary and Backup, so that continued operation of the Generation Facility will be allowed upon failure of one relay until the failure can be repaired or the relay can be replaced.
- IC generation facilities connected to the PPL EU 500 kV or 230 kV systems shall have bidirectional DTT (Direct Transfer Trip) installed to the PPL EU source Substation; this allows rapid clearing for faults which include a stuck breaker. DTT can also be used to ensure that the IC's generation is quickly disconnected from the PPL EU Transmission System for PPL EU supply line faults and to limit interference with existing PPL EU under-frequency and under-voltage schemes.
- Generation facilities connected at 69 kV or 138 kV will require DTT to be installed to provide fast tripping of the generation facility for supply line faults. Local IPR relaying will provide a backup tripping function if the DTT fails to operate during the fault. The primary method of tripping large generators on loss of the PPL EU supply line is by telephone line-based dual-channel DTT or an equivalent fiber optic-based point-to-point communication circuit. The tripping signal to the IC's facility is initiated by either of the following two schemes at the remote PPL EU supply Substation: (1) the supply line

protective relays (2) opening of the supply line breaker. See the discussion on Behind the Meter Generation in **Section 12.4.3.17**.

- High voltage CTs and VTs will be required for the relaying In some cases, the VTs can be supplied with

12.4.3.3 Current and Voltage Transformers

PPL EU will review the voltage transformer (VT) and current transformer (CT) ratios for all devices required for the IPR relaying package. PPL EU requires WYE-connected VTs and WYE-connected CTs. These VTs and CTs shall be relaying class accuracy and be able to support the connected burden during both normal load and fault conditions. Typically, 200 VA VTs and class C400, multi-ratio CTs will be acceptable for facilities using discrete relays. IC will be responsible for determining instrument transformers are adequately sized. IEEE 1547 compliant equipment using remote mounted CTs and VTs will be required to supply equipment compatible with the IEEE 1547 manufacturer's specifications. Equipment with lower ratings shall be reviewed by PPL EU.

For Generation Facilities which are subject to PJM approval, the IC shall also ensure that the CTs and VTs used to provide PJM SCADA and metering information meet the PJM requirements as discussed in "PJM Manual 01: Control Center and Data Exchange Requirements".

Upon request, PPL EU will supply fault current data at or near the point of interconnection (POI) to facilitate the proper sizing of protective equipment.

Note: CT and VT secondary connections are NOT to be shared with any IC or generation relaying, or revenue metering. For <200kV applications, the PPL EU relay packages may share secondary connections. If potential devices with dual or more secondary windings are used, relay and metering functions may share the same potential device as long as separate secondary windings are assigned to each of the following: IC protection functions, POC and IPR protection functions, and revenue metering functions.

Attention: VTs at 69kV and 138kV, located on the PPL EU side of the POC circuit breaker(s) shall have adequate primary (high voltage) fusing to protect PPL EU Transmission Facilities from equipment failure.

12.4.3.4 Generator Relay Settings

The IC shall submit generation trip relay settings to PPL EU upon request. PPL EU will review and accept the settings to ensure proper coordination of the relays with PPL EU operating practices. The IC must apply generator protective relay settings that will provide adequate generator protection to meet IEEE guidelines and applicable requirements.

12.4.3.5 Breaker Failure Protection and Direct Transfer Trip

Breaker failure protection shall be provided on the 500 kV or 230 kV breakers installed in the IC's facilities, as well as the IC's generator circuit breaker and any other circuit breakers in

between. Failure of any circuit breaker shall initiate the breaker failure scheme to clear the Generation Facilities from the PPL EU Transmission System.

The objective of the breaker failure scheme is to isolate the IC's generation from the PPL EU Transmission System for either of the two conditions below:

- Failure to clear the IC's generation for faults detected in the IC's equipment, or
- Failure to clear the IC's generation from the PPL EU Transmission System upon receipt of a DTT signal from the remote PPL EU supply Substation.

If the generator breaker is selected to isolate the IC's generator, then operation of the breaker failure scheme shall clear the IC's POC breaker, or a breaker located between the IC's generator breaker and the POC breaker. If the POC breaker is the designated breaker to isolate the IC's generator, then operation of the breaker failure scheme shall clear the IC's generator breaker, or a breaker located between the IC's generator breaker and the POC breaker. If an intermediate breaker is designated to isolate the IC's generator, then operation of the breaker failure scheme shall clear the POC breaker or the IC's generator breaker.

Breaker failure protection will consist of both local breaker failure protection schemes (designed to isolate the IC's generation from the PPL EU Transmission System when needed) and breaker failure schemes using a DTT signal to be initiated to remotely trip the PPL EU Substation breaker supplying the IC's facilities.

12.4.3.6 Control Switches

The IC shall provide a PPL EU Control Switch (PCS), located in the POC and IPR cabinet for PPL EU use. This switch will provide the capability to locally disconnect the IC's generation from the PPL EU Transmission System by opening the POC breaker or the designated generator isolation breaker when circumstances require manual disconnection. A standard PPL EU control switch (an example is: General Electric Company Type SB-1, Model 16SB1B2X2) or equivalent (subject to PPL EU approval) with target, sliding contacts, handle, and configuration shall be used for the PCS. See **Attachment B – Details for PPL EU Control Switch** for switch details and wiring information. Alternative suppliers for this equipment will be considered as long as the functional requirements are met.

The PCS shall be a three-position switch with spring return from close to normal and from trip to normal. The "Close" position shall be to the right of "Normal" and the "Trip" position shall be to the left of "Normal." This will maintain compatibility with standard PPL EU controls.

There shall be provision for a PPL EU padlock to be installed on the locked cabinet housing this PCS to prevent unauthorized access to this switch.

NOTE: If the IC uses the POC FID as the Generation isolation circuit breaker, the PCS shall only have trip functions wired.

12.4.3.7 POC Breaker Status

PPL EU shall be able to determine the actual status of the IC's generator (on-line or off-line) before any switching is attempted on the safety switch or Point of Contact air switch. Indicating lamps (driven by circuit breaker auxiliary switches) and a means of sensing actual current flow (CTs and an ammeter) or a physical indication of the breaker position (breaker semaphore) shall be available to the PPL EU switchman to verify that the Generation Facilities are not in parallel operation. Multifunction relays can also be used to provide this status.

12.4.3.8 Generator Isolation Breaker

This breaker is typically the main device used to isolate the Generation Facilities from the PPL EU Transmission System. Usually, this breaker is the POC breaker, but it could be a breaker closer to the generator—this selection is to be discussed early in the design phase. It shall be able to withstand a minimum of 2 per unit (p.u.) voltage across the open contacts. It shall be equipped with breaker failure protection to provide an alternate means of isolation of the IC's generation should the breaker fail to trip. It may be necessary to coordinate the breaker failure relaying with PPL EU protective relaying. SF6 insulated breakers require special consideration since loss of SF6 gas pressure will reduce the breaker's dielectric capability and the ability to interrupt current. Consequently, loss of SF6 gas shall initiate a local alarm, and then trip the breaker before the gas pressure is too low to operate the breaker. The manufacturer's recommendation for the specific breaker will be carefully reviewed to determine if the suggested operation on loss of SF6 gas will be acceptable on the PPL EU Transmission System.

12.4.3.9 Indicating Lamps

Two indicating lights shall be located within 6" of the PCS: A red lamp (labeled CLOSED) to indicate when the designated generator isolation circuit breaker is closed, and a green lamp (labeled OPEN) to indicate when the designated generator isolation circuit breaker is open.

12.4.3.10 Control Systems

The control system shall be a DC system; it will use a battery to supply tripping energy to the generator circuit breaker. This DC source shall be continuously monitored by the (27DC) undervoltage relay which will trip the generator circuit breaker if the DC source voltage falls below 10% of nominal. In general, the DC system shall use normally de-energized relays.

All such installations shall isolate (trip) the generator in such a manner that uncontrolled automatic reclosing of the generator breaker cannot occur for:

- A manual tripping operation, or
- An automatic (protective relay initiated) operation. In such situations, a time-delayed automatic synchro-check or voltage-check supervised operation is required to close the generator breaker (contactor) after the PPL EU source has returned to normal.

Under no circumstances is the generator contactor (breaker) to close immediately upon restoration of the PPL EU source. An automatic reclosing operation of these facilities shall be discussed with PPL EU prior to implementation.

An amber or yellow lamp with a nameplate shall be provided to monitor the DC source.

12.4.3.11 PPL EU Reclosing

The requirement for synchronism-check or voltage supervised reclosing of the generation isolation breaker provides protection of the PPL EU Transmission System and the IC's facilities. Unsupervised reclosing with parallel generation could cause damage to the IC's facilities. It is the IC's responsibility to evaluate the potential effect of PPL EU reclosing practices on the generation system and to provide suitable protection.

PPL EU lines operated at 500 kV and 230 kV utilize the following reclosing schedule:

- 500 kV Lines – One shot reclose at 45 cycles (0.75 seconds).
- 230 kV Lines – Two shots reclose at 90 cycles (1.5 seconds) and 900 cycles (15 seconds).

12.4.3.12 Communication Circuits

Communication circuits between PPL EU and the IC are required for DTT (Direct Transfer Trip)

These communication circuits may be provided via fiber, leased telephone lines, or radio links. In general, fiber communication circuits are the preferred medium, but this type of communication circuit depends on the availability of new or existing PPL EU supply lines with sufficient optical fibers. Leased telephone circuits are acceptable but are sometimes difficult to arrange via the telephone companies serving the PPL EU and IC locations.

The different types of telephone communication circuits are discussed below--any or all may be required for an IC's generation installation.

The IC is responsible to order the necessary telephone communication circuits, if that is the specified communication circuit. PPL EU does not initiate the ordering process with the local telephone companies. See **Attachment A – Telephone Circuit Guidance** for information discussing specific information required to place an order with the local telephone company for the required telephone lines.

All leased telephone circuits for DTT shall be available approximately one month prior to synchronism date.

DTT - If leased telephone lines are specified for a particular installation a digital T1 circuit can be provided. The determination of the type of telephone communication circuit (copper or fiber) to be supplied will be made by the telephone company.

PPL EU will provide specific information on the type and quantity of communication circuits to be provided.

Typical protection requirements for the telephone circuits are listed as follows, but a local telephone company may have additional requirements. All copper phone circuits required by PPL EU (DTT) shall be equipped with telephone company approved high voltage isolating devices. See IEEE 487-2015 latest version, and the local telephone company specific

requirements. Note: these specialized phone circuits tend to be long lead items (on the order of 3-6 months or even longer) and may not be available in all locations.

12.4.3.13 General – CTs, VTs, Indicating Metering, Etc.

For all single-phase and three-phase installations greater than 100 kV, location for the source of relay potentials and currents shall be between the high side of the generation power transformer(s) and the high side FID(s). For all single-phase and three-phase installations up to 100 kV where use of high-side VTs and CTs is uneconomical or impractical, these devices may be located on the low-side of the generation power transformer. However, this configuration shall be reviewed and accepted by PPL EU.

All installations shall include:

- An ammeter (for single-phase installations), or an ammeter and a switch to monitor all three phases (for three-phase installations), or suitable 3-phase digital display.
- A visible semaphore on each of the breakers between the generator and the PPL EU Transmission System to determine the actual status of the breaker (open or close).

To prevent a possible undesirable (out-of-phase) connection of the generation to the PPL EU Transmission System, synchronous generators will require a synchronism check relay (25). Induction generators require a voltage check relay (27). These devices shall be located in the IPR cabinet and connected to prevent closing of the generator circuit breaker, or other breaker as agreed to by PPL EU, for:

- An out-of-phase condition.
- A de-energized line condition (PPL EU supply breaker open).
- A de-energized synchronous generator condition.
- An energized induction generator condition.

When a synchronism or voltage check relay is required, the IC shall install a relay accuracy class VT on the generator side of the generator breaker, or other breaker as agreed to by PPL EU, to supply potential to this relay.

For Generation Facilities which are subject to PJM approval, the IC shall also ensure that the CTs and VTs used to provide PJM SCADA and metering information meet the PJM requirements as discussed in “PJM Manual 01: Control Center and Data Exchange Requirements”.

Attention: VTs at 69kV and 138kV, located on the PPL EU side of the POC circuit breaker shall have adequate high voltage fusing to protect PPL EU Transmission Facilities from equipment failure.

12.4.3.14 Typical Methods of Interconnection

The following typical methods interconnection show the major operating characteristics and protection requirements. Each method gives a general review of the types of parallel

connections expected for interconnection to the PPL EU Transmission System. A summary of these interconnection methods are described below.

- Three-phase, 69 kV or 138 kV radial-line connected.
- Three-phase, 69 kV or 138 kV network-line connected.
- Direct Substation or switchyard connected facilities.
- Behind the Meter Generation (BTMG).

Protection requirements applicable to all methods of interconnection:

- The visible break safety switch shall be lockable in the open position and shall be located between the generator and the PPL EU metering point to provide a visible break.
- When more than one (1) breaker is installed between the generator and the PPL EU Point of Interconnection, the IPR relaying shall trip one of the breakers between the generation and the PPL EU Transmission System. The choice of which breaker to trip will usually be determined by discussion between PPL EU and IC personnel, considering the operation of the IC's facility and PPL EU reclosing practices.
- For all installations, the protective relays shall be microprocessor-based units with multiple functions. These relays provide many of the above functions in one case as well as oscillographic and sequence of events capability. All microprocessor-based relays are to be ordered with suitable ports and communication software to allow setting and transferring of data from a laptop computer.
- For induction and synchronous generators, protection will be required to meet IEEE Std. 1547 requirements. At a minimum, this will require over/under voltage, over/under frequency, directional power, and synch-check functions.
- Inverter-based generators meeting IEEE Std. 1547/UL 1741 requirements are acceptable, up to the 200 kVA limit, without additional protection. However, if there are multiple inverters involved, then additional review will be necessary and may result in additional protection requirements.
- AC-powered shunt trips are not acceptable for tripping/isolating the generator unless an appropriate UPS unit is installed.
- An AC undervoltage trip shall be included on the generation isolation breaker if normal tripping is by a DC shunt trip.

12.4.3.15 Three-phase, 69 kV or 138 kV network or radial-line connected

This method of interconnection, shown in **Figure A12.4.2-2**, covers three-phase inverter, synchronous, and induction generators connected to a radial 69 kV or 138 kV circuit. These installations are characterized as follows:

- Being connected through a three-phase transformer (WYE connected high side, delta connected low side).
- Having a high-side circuit breaker.

- Having a switch (POC switch), lockable in the open position, to block the generator from operation.

Radial Protection Requirements

These interconnections require Direct Transfer Trip. The transfer trip will ensure fast tripping of the generator upon receipt of a trip signal from all remote sources. Accordingly, modifications will be required at the remote PPL EU Substation. Selection of the IC's breaker to be tripped for generator isolation upon receipt of the DTT signal will be made after discussion between PPL EU and the IC.

Network Protection Requirements

This method of interconnection normally requires Direct Transfer Trip from both PPL EU Substations. The transfer trip will ensure fast tripping of the generator upon receipt of a trip signal from all remote sources. Accordingly, modifications will be required at both of the remote PPL EU Substations. Selection of the IC's breaker to be tripped for generator isolation upon receipt of the DTT signal will be made after discussion between PPL EU and the IC.

12.4.3.16 Direct Substation connected facilities

In general, PPL EU facilities operated at 230 kV and above on the PPL EU Transmission System are connected in parallel (or network) operation. ICs with generation connecting at this voltage level will connect via a Transmission or sub-Transmission Substation

Such installations will have the following characteristics:

- The generation will be connected by a ring bus (double breaker) or a breaker-and-a-half termination.
- Due to the normal system configuration, for an outage of a single facility, the generation is not isolated with PPL EU load.

Protection Requirements

In cases where Generation Facilities are connected via a Transmission, they will be expected to install a full complement of primary and backup line protection relaying as required for reliability by NERC, RFC, and PPL EU. Relaying will be specified on a case-by-case basis and shall match or accommodate the existing PPL EU line protection or conform to that applicable PPL EU line protection standard. Similarly, the protective relays and control equipment for bus protection, breaker controls, metering, and data telemetering, shall be selected from the applicable PPL EU line protection standard.

Installations with multiple generators will need to apply out-of-step relaying and synchrocheck relaying on a per generator basis, directly on each generator. In general, it will not be practical to apply this protection in the PPL EU relaying cabinet.

Generally, the PPL EU relaying cabinet will not need to contain special protection schemes to prevent accidental generation isolation on IC load, since such load is not directly connected to 230 kV and above facilities. However, certain special protection schemes may be required on a case-by-case basis to comply with RFC and NERC reliability criteria.

The operating-inspection bus configuration of PPL EU Substations (230-69 kV) includes a bus tie breaker to connect the two load buses. The IC shall be informed of the following policy for this type of configuration:

- When the bus tie breaker is used to carry the load of a line which includes an IC with generation which requires DTT, the IC's generation shall be disconnected from the PPL EU Transmission System until the line load is returned to the normal supply breaker.

12.4.3.17 Behind the Meter Generation (BTMG)

BTMG with Momentary Parallel for less than 5 minutes

This method of interconnection applies to generation installed behind the revenue meter of an End-User's Interconnection Facilities. The generation is allowed to parallel with the PPL EU Transmission System for a limited period of time (not greater than 5 minutes), but not send any power onto the PPL EU Transmission System. The End-User's load must always be larger than the generation.

Note: This type is different from a make-before-break transfer switch. A make-before-break transfer switch is expected to parallel for less than 100 milliseconds, and generally does not have a failure mode that will maintain the parallel operation position of the switch. For applications involving transfer switches, contact PPL EU for approval of the proposed transfer switch.

The following minimum requirements shall be met:

- The IC will be required to supply an IPR cabinet with at least the following protective functions:
 - A synchrocheck relay supervises closing of CB used to parallel IC facilities with PPL EU Transmission System when the generator is operating. The need for synchrocheck supervision will be evaluated on a case-by-case basis and will depend on size of the generator and potential impact of an out-of-phase parallel on the PPL EU Transmission System.
 - An undervoltage relay for each phase, or a single three-phase relay.
 - A sensitive reverse power relay (Connected to measure power into the PPL EU Transmission System at the PPL EU/IC intertie location).
 - A timer activated when the generation is paralleled and connected to trip a breaker to separate the generation from the PPL EU Transmission System. Maximum time will be 5 minutes. Timer logic shall be hardwired (not controlled with an electronic device such as a programmable logic controller).

- PPL EU control switch and indicating lights.
- Ammeter and switch.
- Note: Depending on the exact location, size, and type of generation, additional relays may be required. Intertie relays that initiate tripping of the generator need only be in service when the generator is paralleled with the PPL EU Transmission System.
- Due to the minimal relaying, PPL EU will require a "Fail-Safe" AC-powered undervoltage trip control scheme or a DC powered control shunt trip scheme with a backup AC undervoltage trip.
- The generator will not be allowed to send any power into the PPL EU Transmission System.
- IC shall supply a complete set of drawings and system information for PPL EU review.
- PPL EU will assume operational control of the relay(s), etc., in the IPR cabinet.
- PPL EU will specify the time duration for which the generation will be allowed to operate in parallel with the PPL EU Transmission System.

BTMG with no intentional power flow onto the PPL EU Transmission System

This method of interconnection applies to generation installed behind the revenue meter of an End-User's Interconnection Facilities. The Generation Facilities may parallel with the PPL EU Transmission System; however, it may never send any power to the PPL EU Transmission System. These facilities must contain one or more reverse power relays that will be connected and set to detect any power flow into the PPL EU Transmission System. When reverse flow is detected, a suitable device will be operated to immediately remove the generation from the PPL EU Transmission System.

These installations tend to be part of distributed, or campus style installations, and therefore do not lend themselves to a standard design. The IC is required to submit detailed one-line drawings to discuss which devices will operate, and the locations of the various sensing components (CTs, VTs, and associated relaying). PPL EU will review the proposed design and comment, as necessary.

The device to be used to isolate the generation will be determined through discussions between PPL EU and the IC, depending on the operation of the IC's facility.

Depending on the possible impact of the generation on the PPL EU Transmission System, additional protection functions as previously listed for three-phase, 69 kV or 138 kV radial-line/network-line connections may be required in addition to the reverse power relay.

Protection Requirements

For an IC with BTMG operating in parallel with the PPL EU Transmission System, PPL EU requires both POC and IPR protection packages.

The POC protection package will consist of both primary and backup, phase and ground, time and instantaneous overcurrent relays set to detect IC equipment internal faults and trip a fault interrupting device (FID), which will consist of either a circuit breaker or a circuit switcher with adequate interrupting capability.

The IPR protection package will consist of both primary and backup reverse power (or reverse current) relays with over-voltage, under-voltage, over-frequency, and under-frequency elements. In addition, the IPR protection package may also require the installation of a DTT scheme, applied to separate the IC's generation from the PPL EU Transmission System if the PPL EU supply source(s) is(are) opened for any reason.

If the IC's generation capacity is less than one third ($< 1/3$) of the IC's minimum End-User load, then DTT will most likely not be required. The IC's generator will be unable to support the voltage and load, so the IC's generation protection package will separate the IC's generation from the PPL EU Transmission System.

However, if the IC's generation capacity is greater than or equal to one third ($\geq 1/3$) of the IC's minimum End-User load, then DTT will be required to be installed from the PPL EU source Substation to the IC's location. The DTT scheme will initiate a trip signal to separate the IC's generation from the PPL EU Transmission System upon loss of the PPL EU supply. The intent of a BTMG's DTT is to prevent an unintentional island, where the IC's generation carries the load on the line.

Temporary Installations

Temporary installations are those installations where the generation is rented or installed for specific period and is not permanently connected to the PPL EU Transmission System. This generation is also subject to being removed and replaced with different equipment. This generation is strictly limited to BTMG at an End-User's facilities and is usually limited to less than 200 hours of operation per year.

The following items shall be considered for these applications:

- The IPR relaying shall be installed in such a manner that it will not need to be removed or re-installed with the generation.
- Consideration shall be given to limiting or eliminating the connections between the generator controls (tripping, closing, and auxiliary switches), and the use of a single breaker to isolate multiple generators.
- IEEE 1547 requirements shall be met by the relaying, independent of the generation installed.

The entire design of the facility shall take into consideration the probability of changing out the generation equipment on a yearly basis without the need to make changes to the PPL EU required IPR cabinet.



13 Revision History

Revision	Pages	Sections	Description	Issue Date
Rev 0	All	All	<p>Initial Issue. This document – EU00551257 “Transmission Facility Interconnection Requirements” is a consolidation of the documents previously applicable to Interconnection Customers. All requirements have been reviewed and modified as appropriate as part of this release. The intent is to provide a concise and better organized collection of Transmission Facility Interconnection Requirements.</p> <p>The documents that have been superseded and incorporated herein are:</p> <p>EU00542295 “Transmission Protection & Control Relay and Control Requirements for Interconnection of Transmission Voltage Customer-Owned Facilities (500 kV & 230 kV)”</p> <p>EU00530561 “Relay and Control Requirements for Parallel Operation of Generation (138 kV & 69 kV)”</p> <p>EU00513844 “Transmission Protection & Control Point of Contact Requirements for Customer-Owned Facilities (138 kV & 69 kV)”</p> <p>EU00535115_S001 “69/138 kV IPP Point of Interconnection (POI) Typical Diagrams”</p> <p>EU00535116_S001 “230/500 kV IPP Point of Interconnection (POI) Typical Diagrams”</p> <p>Additionally, the Option to Build Standards have been removed and applicability and guidance has been included in Sections 9.1 and 9.2 of this document (EU00551257).</p>	9/18/2020
Rev 1	Various	Various	<p>General clarifications and improvements from Rev 0 and notable changes identified below.</p> <ul style="list-style-type: none"> • Added and/or clarified definitions for Interconnection Facilities, MOLBAB, Point of Contact, Point of Contact Isolation Device, Point of Contact Fault Interrupting Device, and Point of Interconnection. • Section 5, added statement regarding number of terminals for generator lead lines > 200 kV. • Section 6.2, added statement regarding POI feeds from multiple transmission sources under Single-Line Supply description. • Section 8, added clarity regarding POI location and added reference to Attachment D. Table 8.2 and subsequent language as well as Table 8.3 were added. 	4/5/2023



			<ul style="list-style-type: none">• Section 9.3 was reorganized to better reflect a typical sequential order for grounding system designs. Statement added to ground grid testing section regarding 5 ohm ground grid value as a reference value and that the design must be checked against thresholds in IEEE 80.• Section 9.4, combined surge arrester tables and revised the minimum surge arrester ratings to accommodate a temporarily ungrounded system as the default design condition.• Section 9.6, clarified table 9.6-1 headers and added information to the note regarding applicability of phase-to-phase spacing of POC Isolation Devices.• Section 9.7.1, removed statement that secondary windings are at the IC's option. Clarified language for winding configuration requirements in each customer type. Added Table 9.7-1.• Section 9.7.5, modified title of this section to clarify that this is for Point of Contact Fault Interrupting Devices. Fuse switches are only permitted at 69kV. Circuit switchers are permitted as FIDs for End-User Facilities only.• Section 9.7.9 was added to provide guidance regarding legacy equipment.• Section 9.8, removed redundant requirements now contained in Section 8.• Removed Rev 0 Section 10 (for Protection and Control) since it did not contain any material content, only a reference to Appendix A.• Section 10.1, added direction regarding PTs with multiple secondary windings.• Incorporated Rev 0 Appendix A into main body of document as new Section 12.• Section 12.2.1, CT Ratio revised to match other sections.• Section describing ANSI/IEEE Device numbers was omitted.• Section 12.2.6.2, Radio communication for Customer DTT was omitted.• Section 12.2.9, General update on PPL requirements for customer drawings.• Figure 12.3.2.10-1, Diagram updated for clarity.• Figure 12.3.3.9-1, Diagram updated for clarity.• Figure 12.3.4.11-1, Diagram updated for clarity.• Figure 12.4.2-1 and -2, Diagram updated for clarity and separated for >/< 200kV applications.• Section 12.4, SCADA requirements for generating stations were removed.• Re-formatted Attachment A and added additional ordering guidance for T1 circuits.• Added Attachments C and D.	
--	--	--	---	--



Transmission Facility Interconnection
Requirements

Document #: EU00551257
Revision #: 1
Effective Date: 04/05/2023
Page 97 of 107

			<ul style="list-style-type: none">Moved Rev 0 Attachment C to Attachment E and reformatted. Clarified requirements for specific project milestones and extended applicability to all ICs.	
--	--	--	---	--

Attachment A – Telephone Circuit Guidance

TELEPHONE CIRCUIT ORDERING INFORMATION – FIBER CIRCUITS

The telephone infrastructure at the IC's high voltage site will most likely be fiber optic with related equipment, as most telephone companies are rapidly moving away from copper build-outs. In order to accommodate this you will need to complete the following items, prior to the in service or the energization date of your facility. The following are general guidelines to assist you.

HIGH VOLTAGE SITE INFRASTRUCTURE

1. You will need to contact the local telephone company Outside Facilities Engineer (OFE). ***Be aware that the lead time to establish phone service at high voltage sites may be 3-6 months or longer from initial design to installation.***
2. You may be required to provide some site data to allow the telephone company to calculate the maximum Ground Potential Rise (GPR) voltage and the Zone of Influence (ZOI) at your High Voltage site and enable the telephone company to complete their design. Attached is a SAMPLE of the type of information typically requested by the telephone company.
3. ***With a leased line, fiber optic cable solution, understand that each local telephone company has their own specific requirements for the physical equipment needed at your site. It is best to work with their OFE on the design.***

CIRCUIT ORDERING

1. The telephone company OFE will put you in contact with the proper group to place the circuit order. You will need to provide the following information. Most likely, the circuits for SCADA and DTT will be a T1 speed circuit.
 - Complete 911 address (for example, 123 Main St, etc.) for your site AND the terminating ends of the telephone circuits on the PPL EU system.
 - Contact person information for your site AND the corresponding PPL EU site where the circuit(s) are being terminated.
2. A required in service date. You will need to coordinate the in-service date with various PPL EU groups to make certain the PPL EU facilities are ready to accept the circuits. The PPL EU Substation lead engineer following your project can assist you.
3. When ordering a T1 circuit from the Telco, the Telco equipment shall be set with a framing of ESF and coding set to B8Z0. This will correspond with the configuration of the DTT equipment required to be installed. Any changes to these settings will need to be communicated to PPL EU Substation Engineering.
4. **We specifically request that you provide PPL EU Substation Engineering with the circuit identification and in-service date.**



Power Station Request for Telecommunications Service

Telephone Company Contact

Name:

Address:

Phone:

Fax:

Email:

Customer Contact

Name:

Address:

Phone:

Fax:

Email:

Electric Substation Data:

Substation Name/Address:	
Is Substation new or existing? If existing, provide at least 1 existing telephone number	
Square Foot Area: (Total Size of Ground Grid / Ground Mat)	sq. ft.
Total Expected (line-to-ground) Fault Current: (Specify Amps RMS or Peak)	
Grid Impedance (in ohms) to Remote Earth: (Specify Measured or Calculated)	ohms (if measured use fall of potential method)
X/R Ratio:	
% Earth Return Current in Amps:	
Soil Resistivity:	
Telecommunications Peak Factor: (Determined by Telco)	
Peak Ground Potential Rise: (Determined by Telco)	
Remote Earth Point (300 V) distance from Substation Grid: (Determined by Telco)	

Attachment B - Details for PPL EU Control Switch (PCS)

Below is a typical control switch development showing the required functions. This information is taken from a General Electric type SB-1 switch, but alternative suppliers with the same functionality will be considered.

The switch is to have a PISTOL grip handle, with a target (or flag) indicator, and to be spring-return from the close to the normal position and from the trip to the normal position. The target (or flag) will indicate RED for the Normal After Close position, and GREEN for the Normal After Open position. The positions will be Trip, Normal, Close, from left to right when viewed from the front of the switch. The trip and close position shall be approximately 45 degrees off of vertical, and the normal position will be the vertical position.

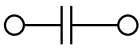
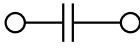
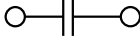
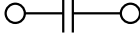
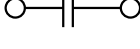
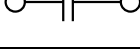
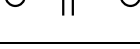
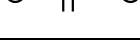
Contact	#	Trip (1)	NAT (2)	NAC (2)	Close (3)
1 1C 	1	X			
2 2C 	2				X
3 3C 	3	X			X
4 4C 	4	X			
5 5C 	5		X	X	
6 6C 	6				
7 7C 	7	X	X		
8 8C 	8	X	X		

FRONT VIEW: ESCUTCHEON ENGRAVING:

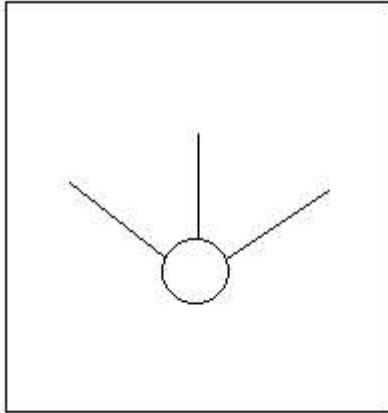

1 TRIP

2

3 CLOSE

NOTE: The Normal After Trip (NAT) and Normal After Close (NAC) position are not engraved.

Control Switch Wiring information:

The PCS shall be wired to **trip but not close** the POC breaker or designated generation isolation breaker for isolation of the IC's generation and to block closing in the "Normal-After Trip" position. The PCS shall be wired to permit closing only when placed in the "Normal-After-Close" position, but it shall not close the breaker directly; it will block closing of the designated generator isolation circuit breaker by the IC's control switch unless the PCS is in the "Normal-After-Close" position.



Attachment C – PPL Pre-approved POC/IPR Equipment

Below table includes all Pre-Approved material associated with Customer Point Of Contact (POC) and Intertie Protective Relaying (IPR) for generator installations. Any other manufacturers/models shall be on a PPL approval basis only.

FUNCTION*	VENDOR	MODEL	COMMENTS
POC/IPR PROTECTION RELAYS	SEL	751	TYPICALLY USED FOR FOR ALL <200kV APPLICATIONS.
POC/IPR PROTECTION RELAYS	SEL	411L	TYPICALLY USED FOR FOR ALL <200kV APPLICATIONS, BASED ON INTERFACE RELAYING.
POC/IPR PROTECTION RELAYS	SEL	421	TYPICALLY USED FOR FOR ALL <200kV APPLICATIONS, BASED ON INTERFACE RELAYING.
DIRECT TRANSFER TRIP (DIRECT FIBER)	SEL	2506	
DIRECT TRANSFER TRIP (DIRECT FIBER)	SEL	2411	
DIRECT TRANSFER TRIP (DIRECT FIBER)	SEL	2440	
DIRECT TRANSFER TRIP (TELECOMMUNICATION)	RFL	GARD 8000	PHONE/T1
CIRCUIT BREAKER CONTROL SWITCH	GE	SB-1	SEE ATTACHMENT B FOR SPECIFIC DETAILS
SLIDING LINK TERMINAL BLOCKS	PHOENIX CONTACT	VARIABLES	SEE EU00551257 FOR SPECIFIC APPLICATION
TEST SWITCHES	ABB	FT-1	

* Note: Specific relaying may be required due to existing conditions outside of this Table.

Attachment D – Interconnection Point Diagrams

Figure 1: Point of Interconnection at a PPL EU Transmission Structure (with OPGW)

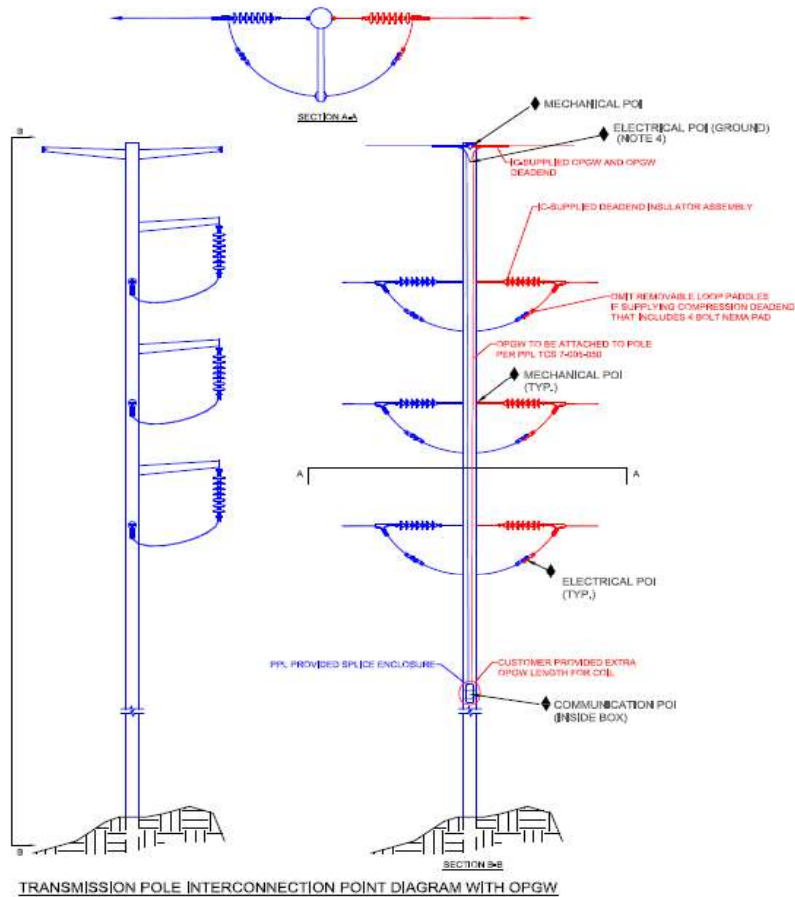

LEGEND

- IC OWNED FACILITIES
- PPL EU OWNED FACILITIES
- ◆ POI
- IC - INTERCONNECTION CUSTOMER
- OPGW - OPTICAL GROUND WIRE (FIBER)
- POI - POINT OF INTERCONNECTION

NOTES

1. THE INTENT OF THIS DIAGRAM IS TO CLEARLY DELINEATE THE OWNERSHIP BOUNDARIES BETWEEN PPL EU AND THE IC. THIS DIAGRAM IS NOT INTENDED TO ILLUSTRATE ACTUAL DESIGN DETAILS. ANY DETAILS ON THIS DIAGRAM THAT MAY ILLUSTRATE ACTUAL DESIGN DETAILS, IN ANY WAY, ARE PURELY COINCIDENTAL.
2. THE TRANSMISSION STRUCTURE ILLUSTRATED IS REPRESENTATIVE OF A TYPICAL TRANSMISSION STRUCTURE. ACTUAL TRANSMISSION STRUCTURE TYPE MAY BE DIFFERENT.
3. SEE PPL EU STANDARD ELECTRICAL ASSEMBLIES FOR MORE INFORMATION. THE NUMBER OF INSULATOR SEGMENTS WILL BE DEPENDENT ON THE LINE VOLTAGE AND BASIC INSULATION LEVEL (BIL) RATINGS.
4. PPL EU AND IC SHALL TERMINATE OPGW INSIDE PPL EU PROVIDED FIBER SPlice BOX IN ACCORDANCE WITH PPL EU STANDARD SPECIFICATIONS.
5. OPGW MUST BE BONDED TO THE TRANSMISSION STRUCTURE IN ACCORDANCE WITH PPL EU STANDARD SPECIFICATIONS.
6. PPL EU SHALL PERFORM END-TO-END FIBER TESTING.

Figure 2: Point of Interconnection at a PPL EU Transmission Structure (with OHGW)

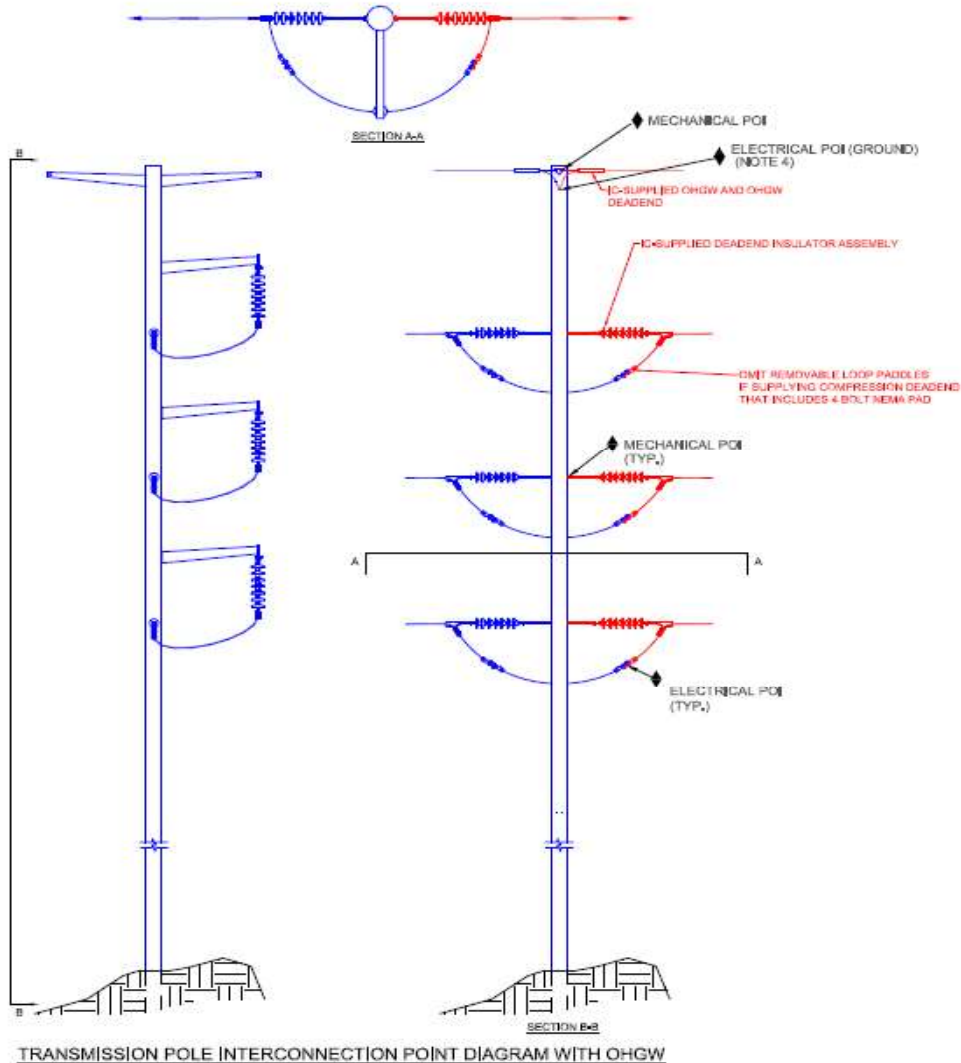

LEGEND

- IC OWNED FACILITIES
- PPL EU OWNED FACILITIES
- ◆ POI
- IC - INTERCONNECTION CUSTOMER
- OHGW - OVERHEAD GROUND WIRE
- POI - POINT OF INTERCONNECTION

NOTES

1. THE INTENT OF THIS DIAGRAM IS TO CLEARLY DELINEATE THE OWNERSHIP BOUNDARIES BETWEEN PPL EU AND THE IC. THIS DIAGRAM IS NOT INTENDED TO ILLUSTRATE ACTUAL DESIGN DETAILS. ANY DETAILS ON THIS DIAGRAM THAT MAY ILLUSTRATE ACTUAL DESIGN DETAILS, IN ANY WAY, ARE PURELY CONcidental.
2. THE TRANSMISSION STRUCTURE ILLUSTRATED IS REPRESENTATIVE OF A TYPICAL TRANSMISSION STRUCTURE. ACTUAL TRANSMISSION STRUCTURE TYPE MAY BE DIFFERENT.
3. SEE PPL EU STANDARD ELECTRICAL ASSEMBLIES FOR MORE INFORMATION. THE NUMBER OF INSULATOR SEGMENTS WILL BE DEPENDENT ON THE LINE VOLTAGE AND BASIC INSULATION LEVEL (BIL) RATINGS.
4. OHGW MUST BE BONDED TO THE TRANSMISSION STRUCTURE IN ACCORDANCE WITH PPL EU STANDARD SPECIFICATIONS.

Figure 3: Point of Interconnection at an IC Substation Deadend Structure (with OPGW)

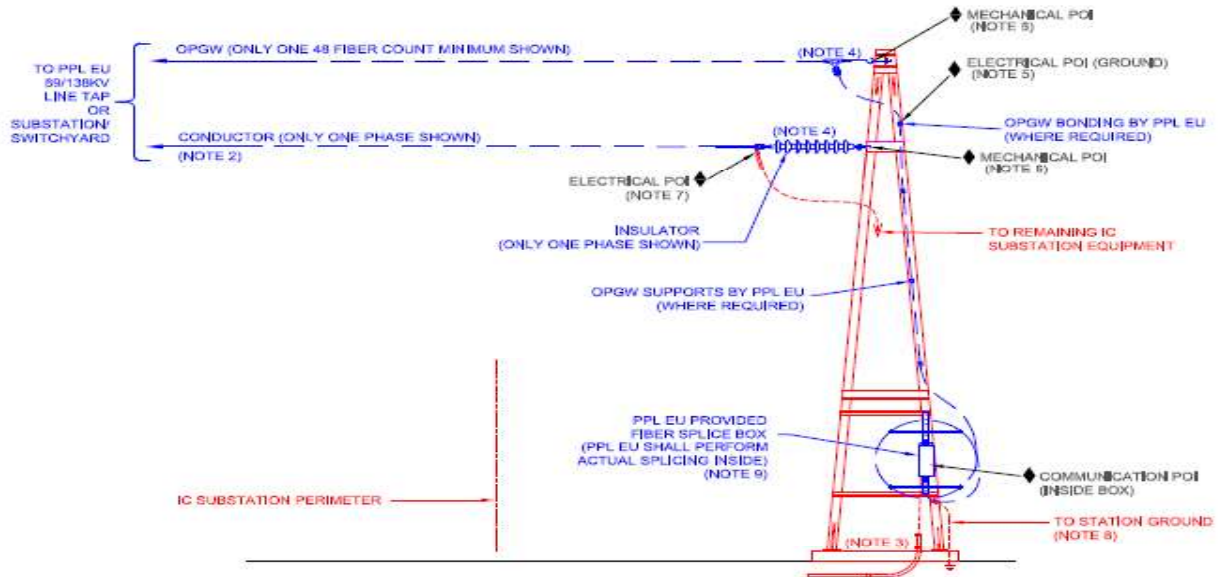

SUBSTATION DEADEND INTERCONNECTION POINT DIAGRAM WITH OPGW

LEGEND

- IC OWNED FACILITIES
- PPL EU OWNED FACILITIES
- ◆ POI
- IC - INTERCONNECTION CUSTOMER
- OPGW - OPTICAL GROUND WIRE (FIBER)
- POI - POINT OF INTERCONNECTION

NOTES

1. THE INTENT OF THIS DIAGRAM IS TO CLEARLY DELINEATE THE OWNERSHIP BOUNDARIES BETWEEN PPL EU AND THE IC. THIS DIAGRAM IS NOT INTENDED TO ILLUSTRATE ACTUAL DESIGN DETAILS. ANY DETAILS ON THIS DIAGRAM THAT MAY ILLUSTRATE ACTUAL DESIGN DETAILS, IN ANY WAY, ARE PURELY COINCIDENTAL.
2. ONLY ONE PHASE CONDUCTOR IS SHOWN FOR CLARITY. MULTIPLE BUNDLED CONDUCTORS (DOUBLE, TRIPLE, ETC.) PER PHASE MAY ALSO EXIST, BUT ARE NOT SHOWN ON THIS DIAGRAM.
3. THE IC DEADEND STRUCTURE ILLUSTRATED IS REPRESENTATIVE OF A TYPICAL DEADEND STRUCTURE. ACTUAL IC DEADEND STRUCTURE TYPE MAY BE DIFFERENT.
4. SEE PPL EU STANDARD ELECTRICAL ASSEMBLIES FOR MORE INFORMATION, THE NUMBER OF INSULATOR SEGMENTS WILL BE DEPENDENT ON THE LINE VOLTAGE AND BASIC INSULATION LEVEL (BIL) RATINGS.
5. PPL EU SHALL FASTEN OPGW AND SUPPORT EXCESS GROUND WIRE DOWN THE IC DEADEND STRUCTURE AND TERMINATE INSIDE PPL EU PROVIDED FIBER SPLICE BOX IN ACCORDANCE WITH PPL EU STANDARD SPECIFICATIONS.
6. PPL EU SHALL PROVIDE AND INSTALL ALL LINE MOUNTING HARDWARE TO CONNECT TO THE IC DEADEND STRUCTURE, THE IC DEADEND STRUCTURE SHALL INCLUDE VANGS IN ACCORDANCE WITH PPL EU STANDARD SPECIFICATIONS.
7. THE IC SHALL PROVIDE AND INSTALL ALL JUMPER LOOP HARDWARE TO CONNECT TO THE PPL EU PHASE CONDUCTOR NEMA PADS.
8. THE IC SHALL GROUND THE OPGW AND DEADEND STRUCTURE IN ACCORDANCE WITH PPL EU STANDARD SPECIFICATIONS.
9. PPL EU SHALL PERFORM END-TO-END FIBER TESTING.

Figure 4: Point of Interconnection at an IC Substation Deadend Structure (with OHGW)

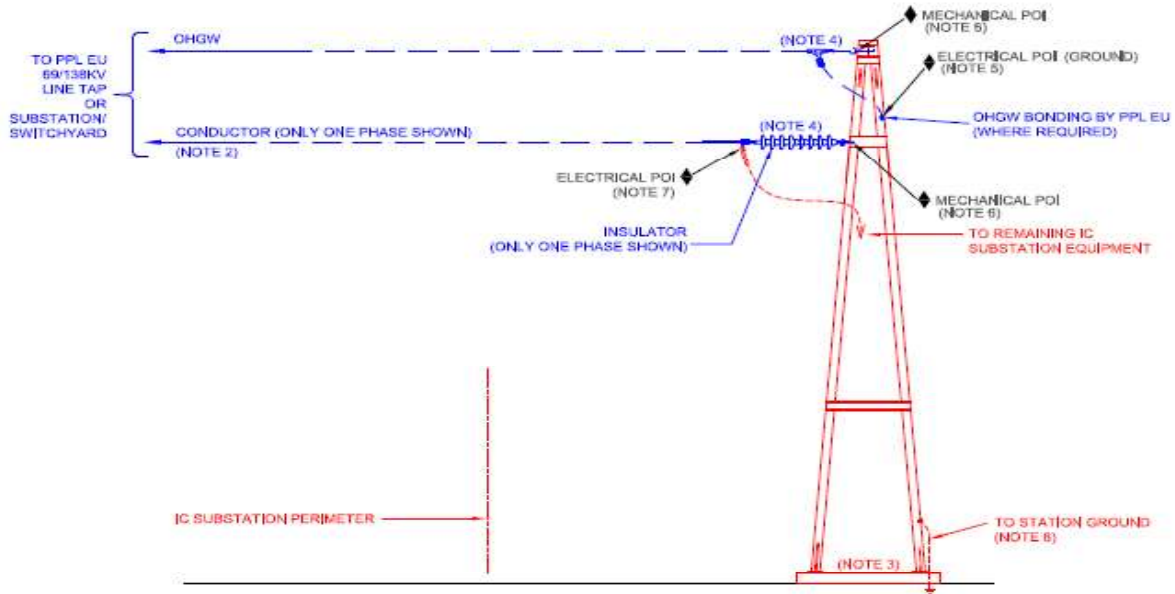

SUBSTATION DEADEND INTERCONNECTION POINT DIAGRAM WITH OHGW

LEGEND

- IC OWNED FACILITIES
- PPL EU OWNED FACILITIES
- ◆ POI
- IC - INTERCONNECTION CUSTOMER
- OHGW - OVERHEAD GROUND WIRE
- POI - POINT OF INTERCONNECTION

NOTES

1. THE INTENT OF THIS DIAGRAM IS TO CLEARLY DELINEATE THE OWNERSHIP BOUNDARIES BETWEEN PPL EU AND THE IC. THIS DIAGRAM IS NOT INTENDED TO ILLUSTRATE ACTUAL DESIGN DETAILS. ANY DETAILS ON THIS DIAGRAM THAT MAY ILLUSTRATE ACTUAL DESIGN DETAILS, IN ANY WAY, ARE PURELY COINCIDENTAL.
2. ONLY ONE PHASE CONDUCTOR IS SHOWN FOR CLARITY. MULTIPLE BUNDLED CONDUCTORS (DOUBLE, TRIPLE, ETC.) PER PHASE MAY ALSO EXIST, BUT ARE NOT SHOWN ON THIS DIAGRAM.
3. THE IC DEADEND STRUCTURE ILLUSTRATED IS REPRESENTATIVE OF A TYPICAL DEADEND STRUCTURE. ACTUAL IC DEADEND STRUCTURE TYPE MAY BE DIFFERENT.
4. SEE PPL EU STANDARD ELECTRICAL ASSEMBLIES FOR MORE INFORMATION. THE NUMBER OF INSULATOR SEGMENTS WILL BE DEPENDENT ON THE LINE VOLTAGE AND BASIC INSULATION LEVEL (BIL) RATINGS.
5. PPL EU SHALL FASTEN OHGW AND PROVIDE EXCESS GROUND WIRE OR JUMPER TO BOND TO THE IC DEADEND STRUCTURE IN ACCORDANCE WITH PPL EU STANDARD SPECIFICATIONS.
6. PPL EU SHALL PROVIDE AND INSTALL ALL LINE MOUNTING HARDWARE TO CONNECT TO THE IC DEADEND STRUCTURE. THE IC DEADEND STRUCTURE SHALL INCLUDE VANGS IN ACCORDANCE WITH PPL EU STANDARD SPECIFICATIONS.
7. THE IC SHALL PROVIDE AND INSTALL ALL JUMPER LOOP HARDWARE TO CONNECT TO THE PPL EU PHASE CONDUCTOR NEMA PADS.
8. THE IC SHALL GROUND THE DEADEND STRUCTURE IN ACCORDANCE WITH PPL EU STANDARD SPECIFICATIONS.

Attachment E – Interconnection Customer Facilities Review and Acceptance Checklist

All applicable items must be reviewed and accepted by PPL EU prior to the identified milestones. The items are in no specific order and may not be all inclusive depending on project specifics.

Engineering and Equipment Procurement

- Site Drawings, including plan and elevation views with location and orientation of proposed IC facilities to the POI
- Single Line Diagram of IC Facilities to POI
- Protection and Control Elementary Drawings, POC/IPR material makes and models
- Switch, interlock schematic and details
- Transmission line dead-end drawings, substation layout specifications
- CT/VT/meter location
- Transformer data sheet and drawings (including kVA, connection, taps, impedance, primary/secondary voltages, phase orientation)
- Draft Land permit application (if permitting PPL EU facilities)
- Executed easements and fee-only land as applicable

Construction Start

- Final IFC drawings for interconnection & customer facilities

Pre-Energization

- Transformer test results
- Metering installation inspection
- Ground resistance test results
- Insulation test results
- Relay test results
- General IC Facility Inspection
- PPL EU Acceptance of IC Facilities & Energization Approval
- Completion of required PPL EU Interconnection Facilities
- Establish when the POC/IPR protection and control equipment is available for testing and setting
- Provide Relay Test with a commissioning plan
- Customer Sequence of Operation/Description of Operation/Operating Instructions
- Supply slide lock bar on substation gate and disconnecting device

Post-Energization

- Final As-Built Drawings, including single line diagram
- Bill of Material (major electrical equipment only)