

Submission of Supplemental Projects for Inclusion in the Local Plan

- **Need Number:** Dayton-2020-006
 - **Process Stage:** Submission of Supplemental Project for inclusion in the Local Plan 3/9/2021
 - **Previously Presented:** Needs Meeting 3/19/2020
Solution Meeting 10/16/2020
 - **Project Driver:** New Customer Delivery Point
 - **Specific Assumption Reference:** Dayton Local Plan Assumptions (Slide 5)
 - **Problem Statement:**
- The Amsterdam-Shelby 138kV transmission line (13827) is approximately 26 miles long and was constructed in 1974 with wood poles.
 - A fault on any portion of this circuit will result in an outage to a large 55MW industrial customer. Depending on system conditions permanent faults on the Shelby side of the line could lead to reduced capacity to serve load for an extended duration.
 - The Amsterdam-Shelby 138kV line has experienced 2 permanent and 4 momentary outages since 2016. The permanent outages were caused by galloping conductors and an auto accident, while the momentary outages were caused by lightning and an animal.
 - The Amsterdam-Shelby 138kV line is critical in providing a 138kV source into the NW area of the DP&L transmission system. In this rural area, there are limited sources and an outage to this source combined with other area outages can lead to operational voltage and loading issues. This contingency is regularly trending in real-time operations and has occurred. Galloping conductors have been problematic in this area causing multiple 69kV outages over the past 2 years causing operational issues to surface.
 - Transmission line equipment issues have been identified along the Amsterdam-New Bremen-St Marys 69kV line (6630) related to vintage cross-arm design and bracing of transmission poles at the base.
 - The 6630 line was constructed in 1970 and is ~8 miles long.
 - This line has experienced 2 permanent and 2 momentary outages since 2016. The majority of the outages were caused by equipment failure.
 - The Village of New Bremen has a peak load of ~20MW of load
 - This corridor serves as a key tie between the Ohio Power and Dayton systems in this area.
 - The Village of Minster is served from two sources, the Covington-Minster-Rossburg 69kV line (6625) and the Amsterdam-Minster 69kV line (6672). During winter storm conditions and with galloping lines in this area, Minster has lost both transmission feeds.
 - The Village of Minster serves ~1,500 customers and has a peak load of ~25MW of load.
 - The 6672 line is ~1.7 miles long and is 1970's cross-arm design and ties into the strongest area source at Amsterdam Sub.
 - The 6672 line has experienced 5 outages, 4 momentary and 1 permanent, since 2016. The majority of the outages were caused by weather, including the permanent outage which was the result of galloping conductors.

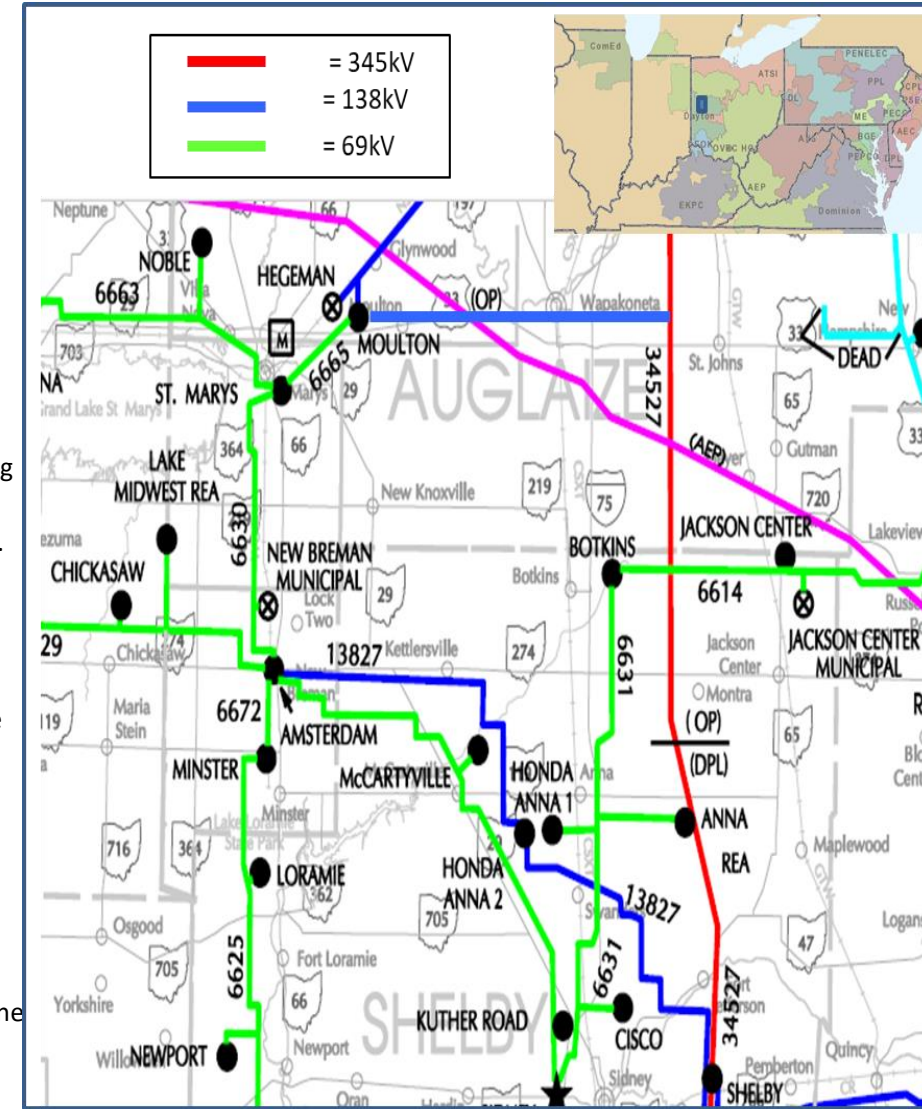
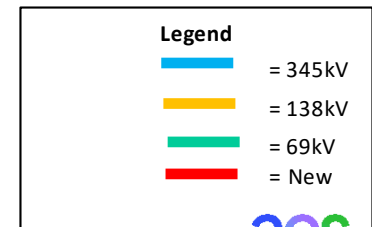
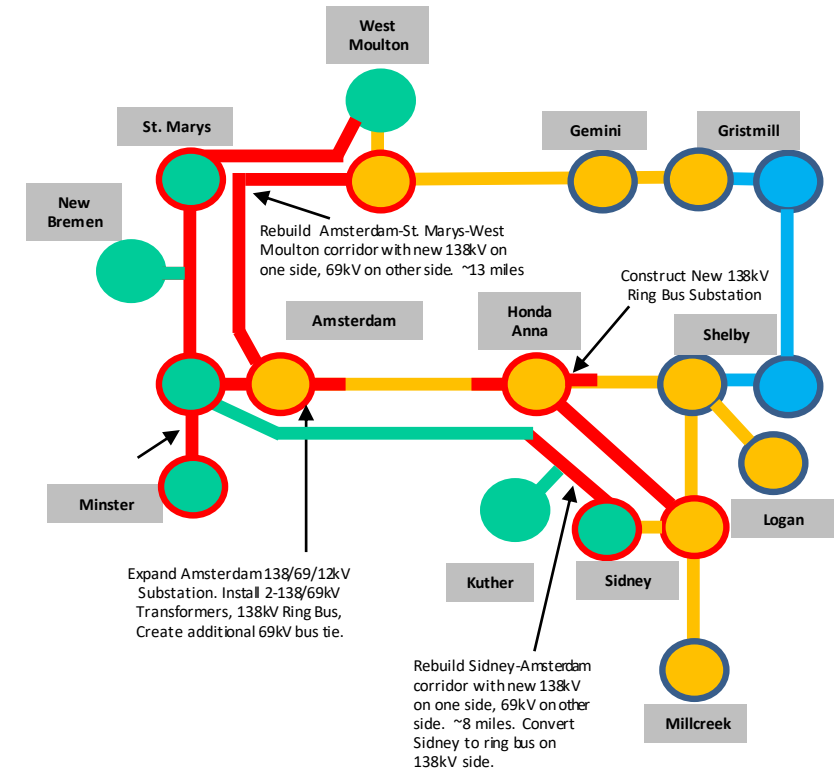

Figure 1 : Area Map

- **Need Number:** Dayton-2020-008
- **Process Stage:** Submission of Supplemental Project for inclusion in the Local Plan 3/9/2021
- **Selected Solution:**
- **Amsterdam-West Moulton 138kV & Sidney-Honda Anna 138kV:** The proposed solution is to rebuild the Amsterdam-St. Marys-West Moulton and Sidney-Amsterdam transmission corridors to double circuit which will help enhance reliability to customers in the North Dayton Area. The project will entail rebuilding existing 69kV transmission line facilities, replacing terminal equipment, and adding new 138kV circuits to each corridor. The rebuild of the Amsterdam-St. Marys-West Moulton corridor and replacement of in-line 69kV switches will be 13 miles and the rebuild of the Sidney-Amsterdam corridor will be 8 miles long stopping near Honda Anna where a single circuit 138kV will be extended to the new substation. At Sidney Substation, a 138kV ring bus will be created which will help alleviate a single outage taking out the source to the Sidney area and provides a diverse additional source to the North Dayton area. The additional sources and rebuild of critical infrastructure will help avoid potential extended outages and improves service to customers in this area. Further these improvements will provide operational flexibility and capacity to handle outage scenarios in the North portion of our service territory which has been prone to multiple and extended outage scenarios during winter ice storms.
- **Estimated Transmission Cost, Amsterdam-St. Marys-West Moulton: \$23.9M, ISD 06/01/2024 (S2398.1)**
- **Estimated Transmission Cost, Sidney-Honda Anna & Sidney Sub: \$17.8M, ISD 12/31/2024 (S2398.2)**
- **Honda Anna Substation:** Construct a new Honda Anna 138kV ring bus substation. This new substation in combination with the other area improvements will increase the reliability of service to the customer and provide greater operational flexibility to the NW system. The additional source into Honda Anna will allow greater flexibility to take system maintenance outages and increases reliability to the currently tapped load. **Estimated Transmission Cost: \$7.9M, ISD 06/01/2024 (S2398.3)**
- **Amsterdam Substation:** This solution will expand the Amsterdam substation to include the new 138kV line and 13827 line in a ring bus arrangement. Also, it will replace the existing Amsterdam transformer and add a second 138/69kV transformer to the substation to ensure redundancy for the 138kV source being added to the area. The 69kV bus would be reconfigured to ensure adequate bus ties and to convert to a more standard design. The existing capacitor will be replaced with two smaller 16MVAR capacitors which will help minimize area voltage changes when the capacitors are switched online. **Estimated Transmission Cost: \$9.3M, ISD 06/01/2024 (S2398.4)**
- **6672 Rebuild:** To address the condition issues on 6672, the solution is to rebuild the 69kV line and associated terminal equipment replacements at Amsterdam and Minster Substations. The new line will help ensure more resilience during winter weather events. **Estimated Transmission Cost: \$2.7M, ISD 6/1/2024 (S2398.5)**
- **West Moulton Substation :** AEP will install an additional 3000A, 63kA circuit breaker to their ring bus being constructed as part of the City of Wapakoneta Project (s1856) **Estimated Transmission Cost: \$3.5M, ISD 06/01/2024 (S2398.6)**
- AEP will also install a pole outside of West Moulton Substation and a single span of line to connect the West Moulton-Amsterdam 138kV circuit. **Estimate Transmission Cost: \$0.25M, ISD 06/01/2024 (S2398.7)**
- **Total Estimated cost :** \$65.35M.
- **Projected In-Service:** 12/31/2024
- **Project Status:** Conceptual
- **Model:** 2020 RTEP – 2025 Summer Case
- **Supplemental Project ID :** S2398.1 -.7



- **Need Number:** Dayton-2020-008
- **Process Stage:** Submission of Supplemental Project for inclusion in the Local Plan 3/9/2021
- **Previously Presented:** Needs Meeting 7/17/2020
Solution Meeting 10/16/2020
- **Project Driver:** New Customer Delivery Point
- **Specific Assumption Reference:** Dayton Local Plan Assumptions (Slide 5)
- **Problem Statement:**
 - Buckeye Power, on behalf of South Central Power, has requested a new transmission delivery point in Fayette County, Ohio.
 - The primary function of this new delivery point will be to serve existing load that is presently being served from another substation roughly 12 miles away.
 - The proposed delivery point is located immediately east of DP&L's Washington Courthouse-Greenfield 69kV (6649) transmission line.
 - Washington Courthouse and Greenfield substations are shown in Figure 1 where the 69kV lines are marked in green and the approximate location of the new delivery point is highlighted with a yellow star on the map.
 - Initial loading of the proposed delivery point is projected to be 3 MW and emergency loading could be up to 5MW.
 - Service to the new delivery point is required by June 2022.

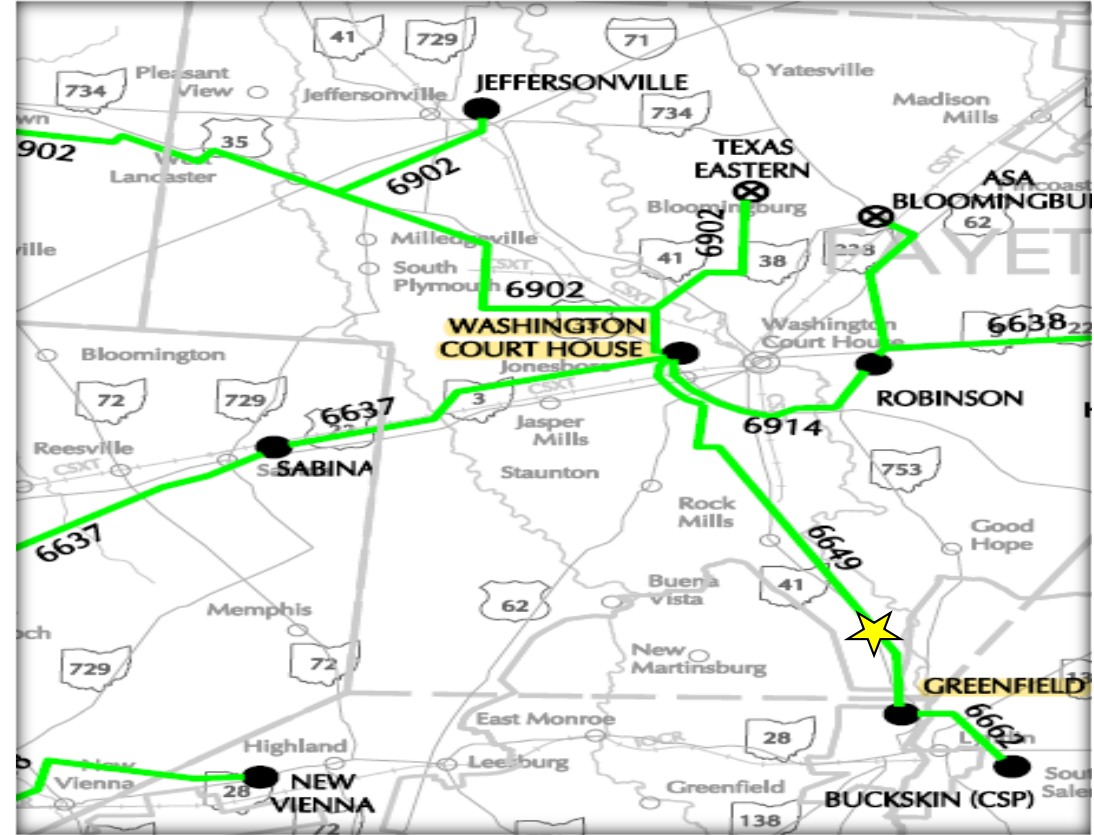
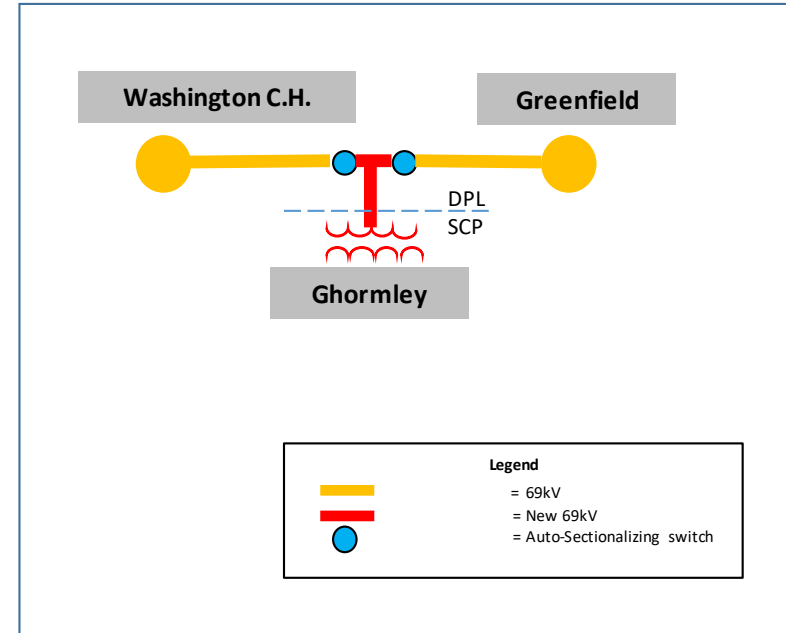
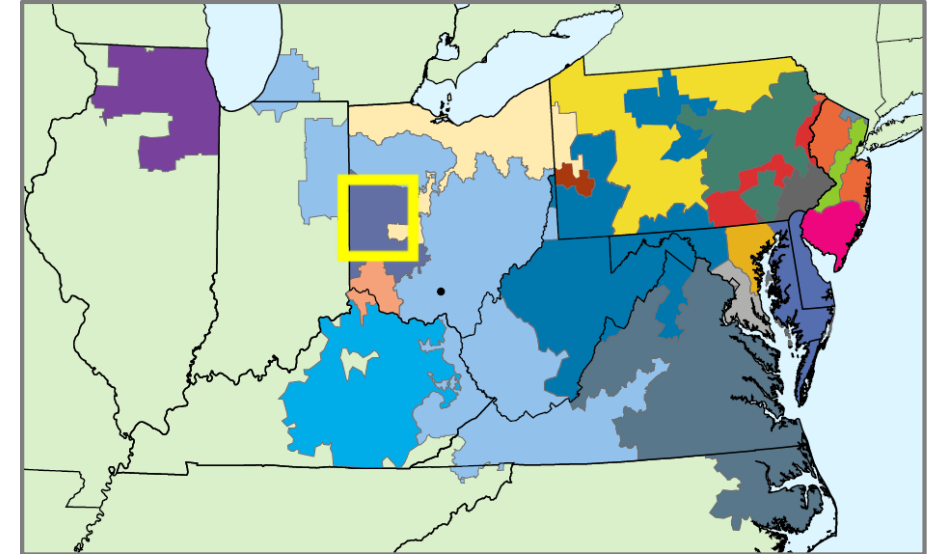

Figure 1 : Area Map

- **Need Number:** Dayton-2020-008
- **Process Stage:** Submission of Supplemental Project for inclusion in the Local Plan 3/9/2021
- **Selected Solution:**
 - The solution to address this need will be to tap the Greenfield-Washington Courthouse 6649 69kV line and to install 3 new poles with a set of 1-way switches on each new structure to serve a new South Central Power Ghormley Delivery Point.
 - The new switch installation will have automatic sectionalizing controls to restore to the Ghormley Delivery Point for faults on either the Washington Courthouse or Greenfield side of the line.
 - **Estimated cost :** \$350k.
 - **Projected In-Service:** 6/1/2022
 - **Project Status:** Conceptual
 - **Model:** 2020 RTEP – 2025 Summer Case
 - **Supplemental Project ID :** s2399



- **Need Number:** Dayton-2020-009
- **Process Stage:** Submission of Supplemental Project for inclusion in the Local Plan
- **Previously Presented:** Needs Meeting 10/16/2020
Solution Meeting 12/18/2020
- **Project Driver:** System Configuration Improvements, Operational Performance
- **Specific Assumption Reference:** Dayton Local Plan Assumptions (Slide 5)
- **Problem Statement:**
- Historically Dayton assumed a 50/50 current split in our ratings methodology.
- Under certain outage conditions, lines or transformers may be isolated on a single element with 100% of the flow through that facility.
- After reviewing industry best practices, DP&L plans to move from a 50/50 current split assumption to a 100/0 current split assumption starting January 1, 2023.
- Modeling single elements derates in the planning model is in implementation and will require contingency change updates in the future, but modeling these specific scenarios in the operations model was not a feasible long-term plan for DP&L.
- Certain terminal equipment changes will be made at DP&L substations to maintain current ratings and other facilities will take the derate from the change in methodology based on reviews of historical loading, contingency loading, and criticality as reviewed by planning and operations.
- The decision to proceed with the changes was driven by the desire to avoid unplanned facility outages due to potential loading issues and the low cost of making terminal equipment upgrades to avoid these scenarios.
- **Model: 2020 RTEP Series, 2025 Summer Case**



- **Need Number:** Dayton-2020-009
- **Process Stage:** Submission of Supplemental Project for inclusion in the Local Plan
- **Selected Solution:**
- **Substation Terminal Equipment Replacements:** Dayton will complete terminal equipment replacements at the substations listed in the bullets below to facilitate the transition to a 100/0 current split methodology. These changes will involve the replacement of breakers, breaker terminal pads, and switches that could become a limiting element once the shift is made in the ratings methodology. The upgrades on these facilities will ensure ratings are kept the same as today.
 - Bath Substation – Replace GL-EE, GL-FF, GL-HH 345kV circuit breakers that terminate Bath-Foster 34598 line
 - Clinton Substation – Replace Breaker terminal pads on HE-EE
 - Greene Substation – Replace circuit breaker terminal pads on GJ-AA, GJ-BB, GJ-CC, GJ-DD, GJ-EE, GJ-FF and disconnect switches
 - Miami Substation - Replace Breaker terminal pads on OB-GG, OB-HH, disconnects, and metering limit
 - Shelby Substation – Replace BC-B and BC-D circuit breakers and the disconnect switches
 - Stuart Substation – Replace Breaker terminal pads on ST-JJ, ST-KK, ST-HH, ST-GG, ST-VV, ST-WW
 - Sugarcreek Substation – Replace RS-BB, RS-DD, RS-EE, RS-FF, RS-HH, RS-JJ breaker terminal pads.
 - West Manchester Substation – Replace MC-6643W and MC-6643W 69kV circuit breakers and disconnect switches
 - Wilmington Substation – Replace HB-2 and HB-7 circuit breakers, disconnect switches, and bus.
- **Transmission Line Derates:** Once the new methodology is put in place starting 1/1/2023, the transmission circuits in the table below will be derated since equipment replacements will be completed. Based on engineering review, there are no anticipated issues from the planned derates.

Equipment replacements

Substation	Line(s)
Bath	34598/34526/34525
Clinton	34509/34522
Greene	34503/34506/34522/34525
Miami	34525
Shelby	BK-S, 34527
Stuart	34509, 34510, 34511, 34553
Sugarcreek	34524
West Manchester	6643
Wilmington	6673

- **Estimated cost :** \$6.8M
- **Projected In-Service:** 12/31/2022
- **Project Status:** Conceptual
- **Model:** 2020 RTEP – 2025 Summer Case
- **Supplemental Project ID :** s2423

Line	SN Before Rating	SN After Rating	SE Before Rating	SE After Rating	WN Before Rating	WN After Rating	WE Before Rating	WE After Rating
x34528 x	1255	1099	1374	1195	1255	1195	1374	1195
x13805 x	196	196	241	241	270	270	301	287
x6666 x	151	126	187	143	201	143	220	143
x6674 x	95	95	117	117	132	132	147	143
x6677 x	151	151	187	187	209	202	234	225
x6905 x	151	143	165	143	151	143	165	143
Overlook Bk-7	200	187	220	216	200	200	220	220
Amsterdam 138/69kV	150	143	165	143	150	143	165	143
Trebein 138/69kV	200	193	220	220	200	200	200	220
Staunton 138/69kV	187	165	216	192	200	200	220	220
Bath 345/138kV	450	450	495	478	450	450	495	478
Miami 345/138kV	450	450	495	478	450	450	495	478
W. Milton 345/138kV	450	440	496	478	450	450	495	478
Sugarcreek 345/138kV N	448	448	493	478	448	448	493	478
Sugarcreek 345/138kV S	450	450	495	478	450	450	495	478

- **Need Number:** Dayton-2020-012
- **Process Stage:** Submission of Supplemental Project for inclusion in the Local Plan 5/21/2021
- **Previously Presented:** Needs Meeting 12/18/2020
Solution Meeting 02/17/2021
- **Project Driver:** Source for underlying distribution
- **Specific Assumption Reference:** Dayton Local Plan Assumptions (Slide 5)
- **Problem Statement:**
 - A large new senior community featuring a mix of residential, and retail is being constructed in the Cornerstone Development located in Centerville, OH. This area, served from Dayton’s Carpenter Substation, has experienced growth in recent years and this load addition of 5MVA will require additional capacity. Dayton must develop a solution to have capacity to serve distribution load in this load center or risk overloading existing equipment and not having sufficient distribution capacity to serve growing load.
 - Carpenter Substation is served via a short 0.1-mile tap from the Alpha-Hempstead 6622 69kV transmission line. Carpenter Substation provides distribution service to the 3,4000 customers served in this area via a single 69/12kV 30MVA transformer. A single outage to the 6622 transmission line or distribution transformer at Carpenter would result in a complete loss of service to the 3400 customers.
 - The current load (24.4 MVA) and reserved emergency switching capacity (3.5 MVA) place the current 69/12kV 30MVA transformer at Carpenter above 90% of its rating during peak times before the 5MVA load addition.
 - Additional circuit ties exist in the area but do not have enough capacity for significant load transfers and would further limit the ability to conduct circuit switching during outages.

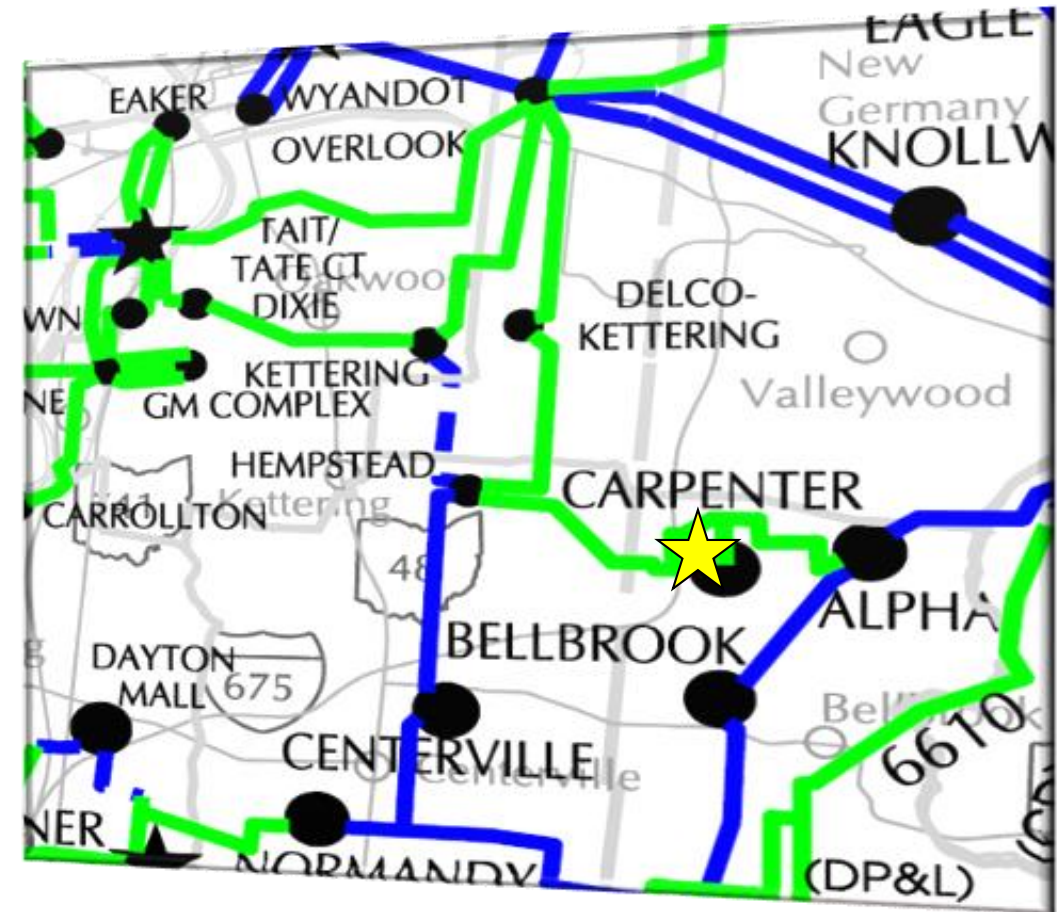
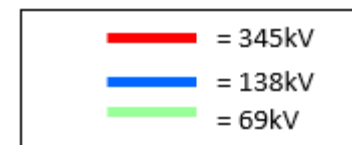
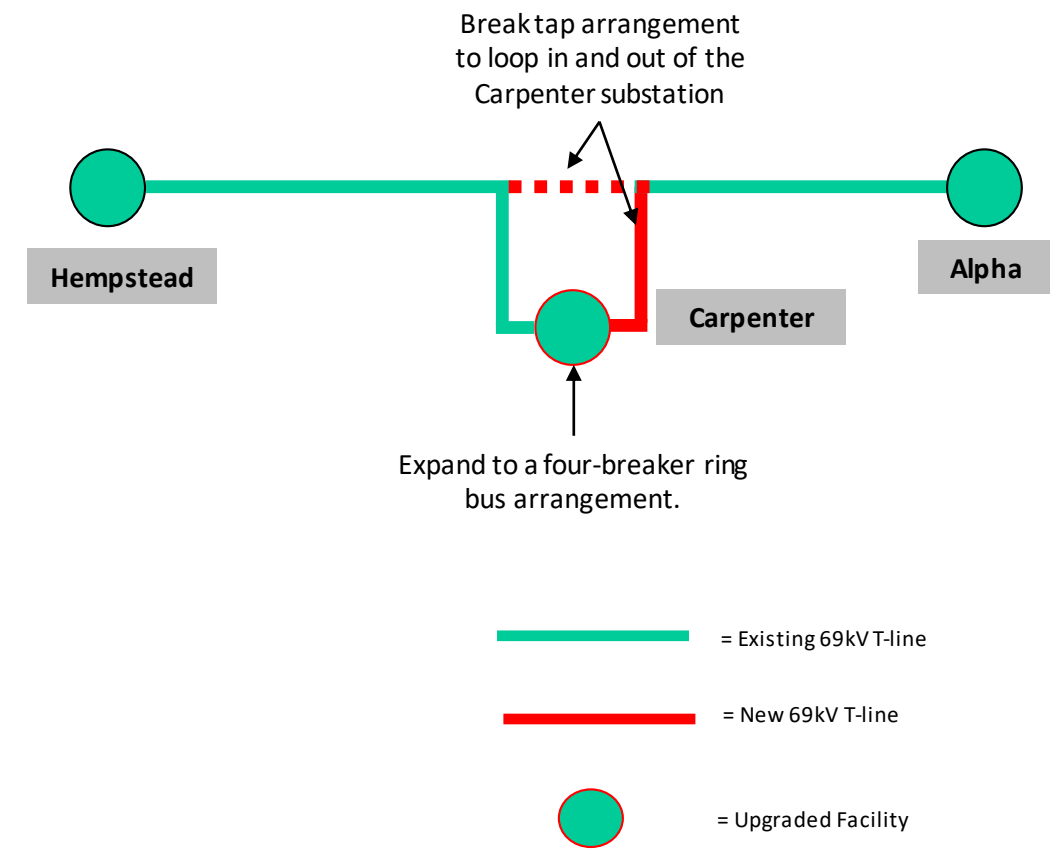

Figure 1 : Area Map



- **Need Number:** Dayton-2020-012
- **Process Stage:** Submission of Supplemental Project for inclusion in the Local Plan 5/21/2021
- **Selected Solution:**
 - 6622 Alpha – Hempstead 69kV: The tap that currently serves the Carpenter Substation off the 6622 line will be converted to a loop in and out of Carpenter Substation with this project. The extension involves the addition of four spans of 69kV line which will terminate the 6622 line into two new breaker positions. The new switch installation will have automatic sectionalizing controls to restore to the Ghormley Delivery Point for faults on either the Washington Courthouse or Greenfield side of the line. **Estimated cost** : \$0.3 M (s2462.1)
 - Carpenter Substation: Carpenter Substation will be expanded into a four-breaker ring bus substation to terminate the new looped feed configuration and will terminate a new 69/12kV transformer that will provide capacity to the growing load center. The new ring bus will reduce exposure to line outages and will also provide switching flexibility for maintenance outages. **Estimated cost** : \$3.2 M (s2462.2)
 - **Total Estimated cost** : \$3.5 million.
 - **Projected In-Service:** 12/31/2021
 - **Project Status:** Conceptual
 - **Model:** 2020 RTEP – 2025 Summer Case
 - **Supplemental Project ID** : s2462.1 and s2462.2



Need Number: Dayton-2020-010

Process Stage: Submission of Supplemental Project for inclusion in the Local Plan

Previously Presented: Needs Meeting 11/20/2020
Solution Meeting 02/17/2021

Project Driver: Requested Customer Upgrade, Operational Performance

Specific Assumption Reference: Dayton Local Plan Assumptions (Slide 5)

Problem Statement:

- Buckeye Power, on behalf of Pioneer Rural Electric Cooperative, has requested reliability upgrades on the Staunton-KTH 69kV 6657 line located in Miami and Champaign Counties.
- The 6657 line is a radial 17-mile 69kV wood pole line connecting DPL's Staunton Substation to Pioneer's KTH delivery point.
 - The line was constructed primarily in the 1960's and is approximately 17 miles long.
 - The line has experienced 2 permanent and 3 momentary outages since 2016. Most outages were caused by lightning.
 - The line serves approximately 19MW of load between East Casstown, St. Paris, and KTH substations.
 - Loss of the 6657 line could lead to extended customer outages for customers served via East Casstown, St. Paris, and KTH due to the current radial configuration and limited switching options.
- The KTH delivery point served at the end of the radial 6657 line provides service to KTH a large auto parts manufacturer and the largest employer in Champaign County.

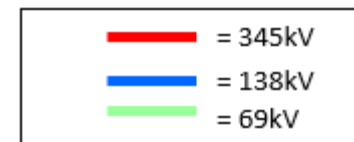
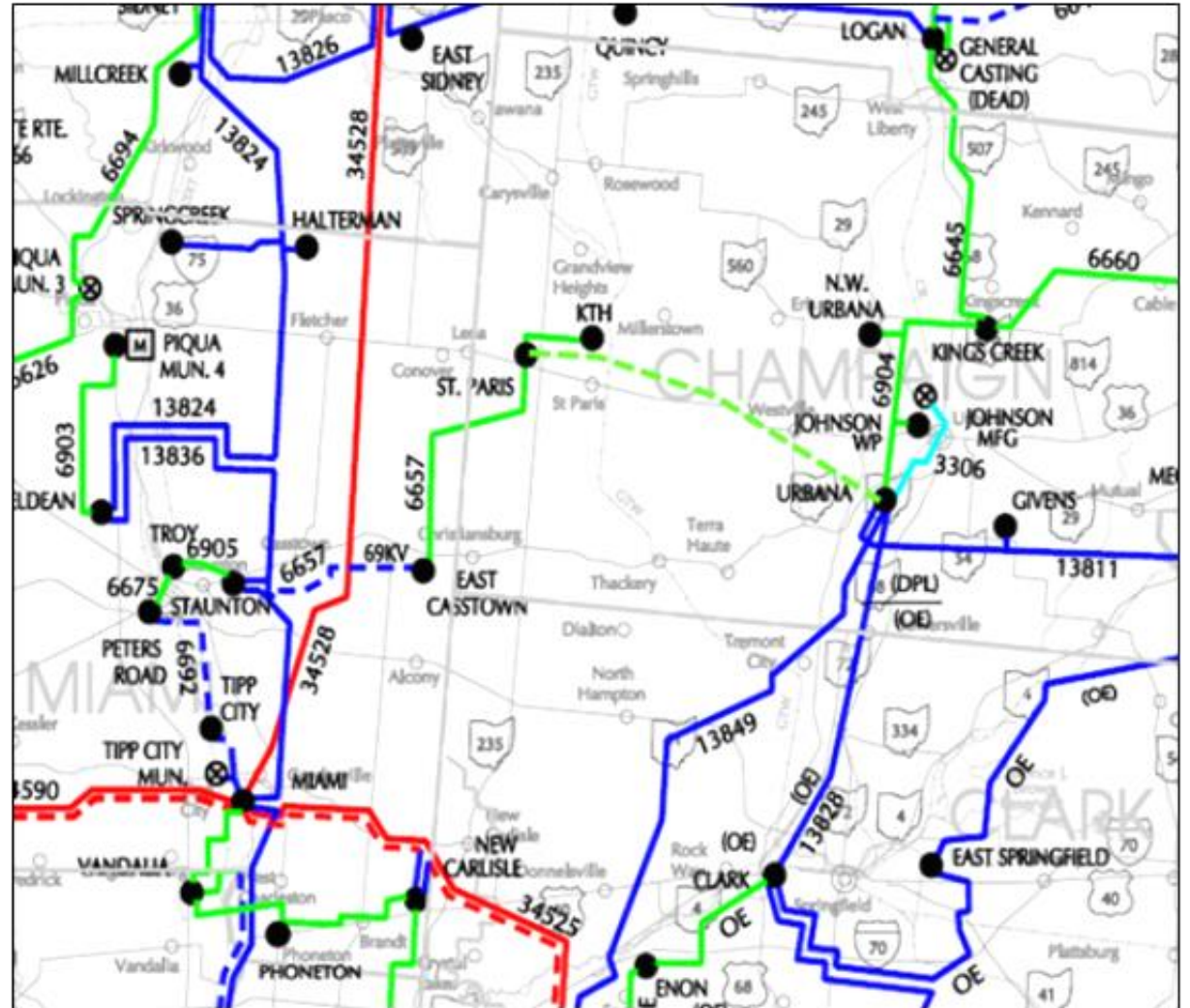

Need Number: Dayton-2020-010

Process Stage: Submission of Supplemental Project for inclusion in the Local Plan 5/24/2021

Selected Solution:

- **St. Paris – Urbana 69kV Line & KTH Alternate Delivery:** Construct a new 12.6-mile single circuit 69kV line utilizing 1351 AAC conductor. (Ratings: SN-151, SE-187) **Estimated cost** : \$13.65 M (s2461.1)
 - **Second KTH Delivery:** Provide a second delivery to KTH, who is a large auto parts manufacturer and Champaign County’s largest employer. Establish a new 69kV three-way MOAB switch along the St. Paris – Urbana 69kV line. **Estimated cost** : \$0.55 M (s2461.2)
 - **Urbana Substation:** Extend the 69kV west bus and install four new 69kV circuit breakers. The new line will terminate into a single 69kV circuit breaker off the existing east bus and relocate the capacitor to a new 69kV circuit breaker off the west bus. The 138/69kV transformer will be relocated to a new double bus double breaker string that will serve as a second bus tie at the substation. This additional bus tie breaker position will provide additional operational flexibility to take maintenance outages at the substation and keep the transformer source connected to the 69kV load center. **Estimated cost** : \$3.5 M (s2461.3)
 - **Casstown Switching Enhancement:** Replace the 65703 line disconnect switch toward St. Paris with a new three-way MOAB switch to eliminate the Casstown hard tap configuration. With the new source being added, the Casstown load will now be able to be served from the Urbana Source for permanent outages on the Staunton source. **Estimated cost** : \$0.55 M (s2461.4)
 - **St. Paris Substation:** Construct a new four breaker 69kV ring bus configuration to terminate the new 69kV transmission line from Urbana. The new ring bus will expand the existing substation to ensure a two-way source to load at St. Paris and provides switching flexibility for maintenance of equipment at St. Paris **Estimated cost** : \$2.8 M (s2461.5)
- **Total Estimated cost** : \$21.05 million.
 - **Projected In-Service:** 12/31/2023
 - **Project Status:** Conceptual
 - **Model:** 2020 RTEP – 2025 Summer Case
 - **Supplemental Project ID** : s2461.1-5

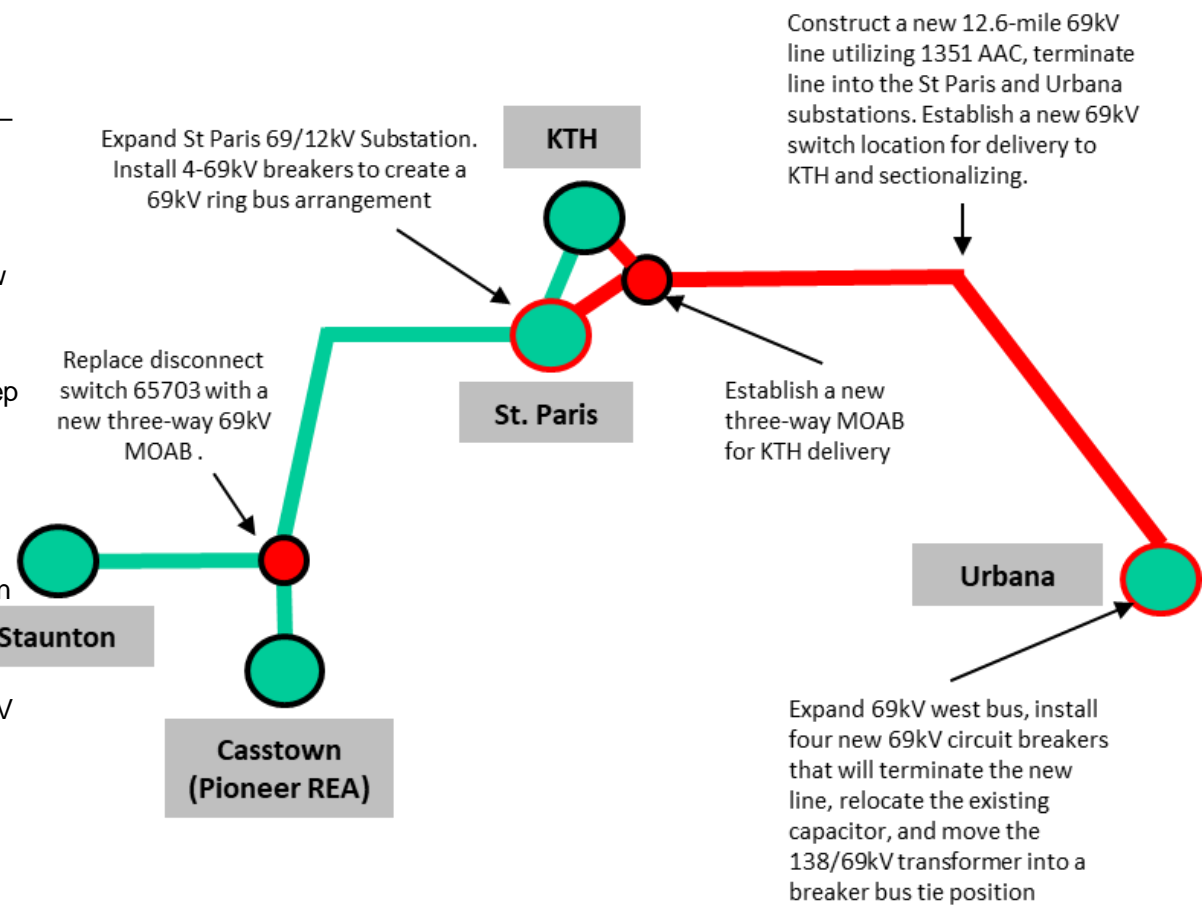

Need Number: Dayton-2020-005

Process Stage: Submission of Supplemental Project for inclusion in the Local Plan 7/12/2021

Previously Presented: Need Meeting 03/19/2020

Solution Meeting 04/16/2021

Supplemental Project Driver(s): Requested customer upgrade, Operational performance

Specific Assumption Reference: Dayton Local Plan Assumptions (Slide 5)

Problem Statement:

The NW portion of the Dayton transmission system has experienced several real-time performance events over the last 5 years as a result of aging infrastructure and legacy system design.

- The Coldwater to Rossburg 69kV line (6684) is ~28 miles long and was built in 1967 with wood poles.
 - The line provides transmission and distribution service to 4 tapped substations including 1 Dayton delivery point and 3 cooperative delivery points. The line serves approximately 3,500 customers representing approximately 30 MW of peak load.
 - This line has experienced 8 permanent outages and 23 momentary outages in the last 3 years. The most common outage cause was equipment failures, particularly on the Macedon tap and between Sharpsburg and Rose Hill.
 - DP&L has a related project in the vicinity, s0327, which would help provide a source into the NW system on the Coldwater -Rossburg 6684 line.
- The Celina-Coldwater-Rockford 69kV line (6688) is ~23 miles long and was constructed in 1990 with wood poles and crossarm design.
 - The 6688 line provides service to 2 delivery points, serving approximately 1,900 customers and 12 MW of peak load.
 - This line has experienced 10 permanent and 12 momentary outages since 2016, with the primary causes being equipment failure and weather.
 - Dayton has a normally open 33kV tie (3339) with Ohio Power at Rockford Sub that is built to 69kV standards. This is an out of phase tie point and can only be closed if the 12kV Rockford bus is de-energized and 3339 line is energized from Ohio Power. Since this is a normally open point, the Rockford load is radial under most operating conditions since a manual process must take place to switch the load to the Ohio Power source if there is an issue with the Celina-Coldwater-Rockford 6688 69kV line.
 - The Rockford Substation is one of the most remote areas on the Dayton system and lacks nearby sources.
- The Amsterdam-Coldwater 69kV line (6629) is ~17 miles long and was constructed in 1991 with wood poles and crossarm design.
 - The line provides transmission and distribution service to 3 tapped substations including 1 Dayton delivery point and 2 cooperative delivery points. The line serves approximately 3,500 customers representing approximately 18 MW of peak load.
 - This line has experienced 6 permanent outages and 8 momentary outages since 2016. The most common outage causes were equipment failures and weather.
- DP&L provides 69kV service to the City of Celina from a very small 69kV switching station. This legacy design has a single point of failure that has become problematic for equipment maintenance and outages.
 - The peak load for the City of Celina is ~43 MW.
 - A bus or line fault on Celina's system interrupts both of the 69kV deliveries to Celina.
 - Due to the size of the switching station, there is very limited ability to expand or improve the configuration.

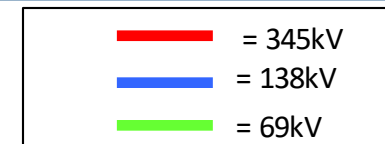
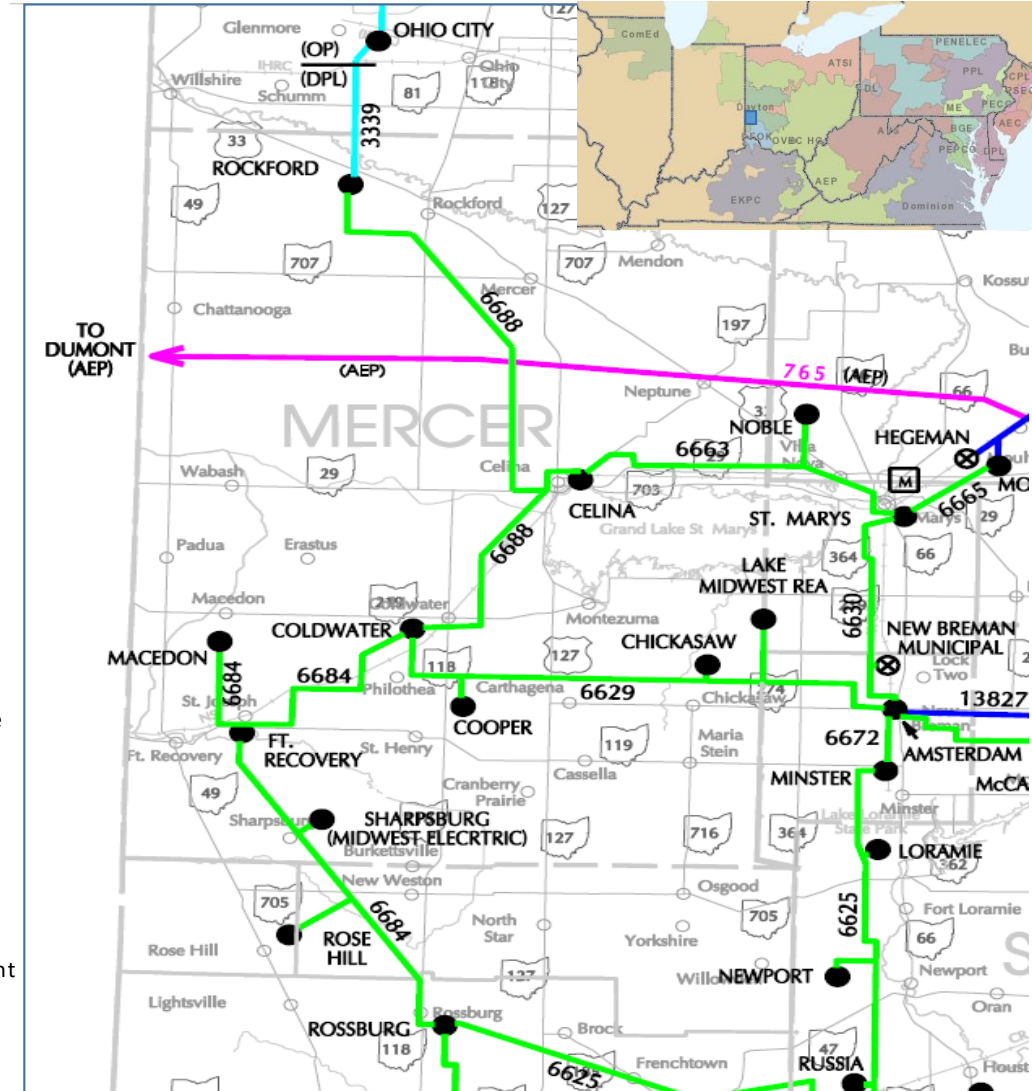

Need Number: Dayton-2020-005

Process Stage: Submission of Supplemental Project for inclusion in the Local Plan 7/12/2021

Selected Solution:

Rockford Substation: In coordination with AEP, DP&L will retire the Rockford 69/34.5kV transformer and construct a new 69kV three breaker ring configuration to close in this normally open tie at 69kV in the future. (S2521.1)

Estimated Transmission Cost: \$3.6M, ISD 12/01/2025

Celina – Coldwater – Rockford 69kV: Rebuild 2.5 miles of the existing 69kV line to double circuit and construct of 1.0 mile of new 69kV line to reroute the Celina – Coldwater - Rockford 69kV extension into the relocated Celina 69kV substation. (S2521.2)

Estimated Transmission Cost: \$6.3M, ISD 12/01/2025

Celina Substation: Retire the existing Celina 69kV substation due to condition and the limitations to expand at the current location. Establish a new 69kV breaker and one-half configuration and two new 69kV capacitor banks at a new substation located on the western edge of Celina. The associated breaker and one-half configuration will reduce the total line exposure, eliminate the three-terminal line arrangement, and provide localize reactive compensation to the Celina load. (S2521.3)

Estimated Transmission Cost: \$10.2M, ISD 12/01/2025

Chickasaw Circuit Breaker (6629): Circuit breakers will be installed at Chickasaw Substation to decrease the exposure on the Amsterdam - Coldwater 69kV 6629 line to improve reliability. (S2521.4)

Estimated Transmission Cost: \$5.0M, ISD 12/31/2025

Ft. Recovery Sub & 6684: 69kV circuit breakers will be installed at Ft. Recovery Substation to decrease the exposure on the line to improve reliability. The tap to Macedon will be brought into a breaker position within Ft. Recovery which will further decrease exposure on the system. This will require rebuilding approximately 0.15 miles of 69kV line as double circuit into the sub. The capacitor proposed as part of s0327 will be installed at Ft. Recovery as 2-15MVAR cap banks. The Ft. Recovery-Jay line and transformer (s0327, s0328) will be delayed until 12/31/2025. (S2521.5)

Estimated Transmission Cost: \$3.5M, ISD 12/31/2025

Sharpsburg, Rosehill, Cooper, & Lake Sectionalizing

New automatic 69kV MOABs switches with supervisory control will be installed at each delivery point to reduce local area interruptions during outage conditions on their associated circuits. (S2521.6)

Estimated Transmission Cost: \$2.5M, ISD 12/31/2023

Total Estimated Transmission Cost: \$31.1M

Project Status: Conceptual

Model: 2020 RTEP – 2025 Summer Case

Supplemental Project ID : s2521.1-.6

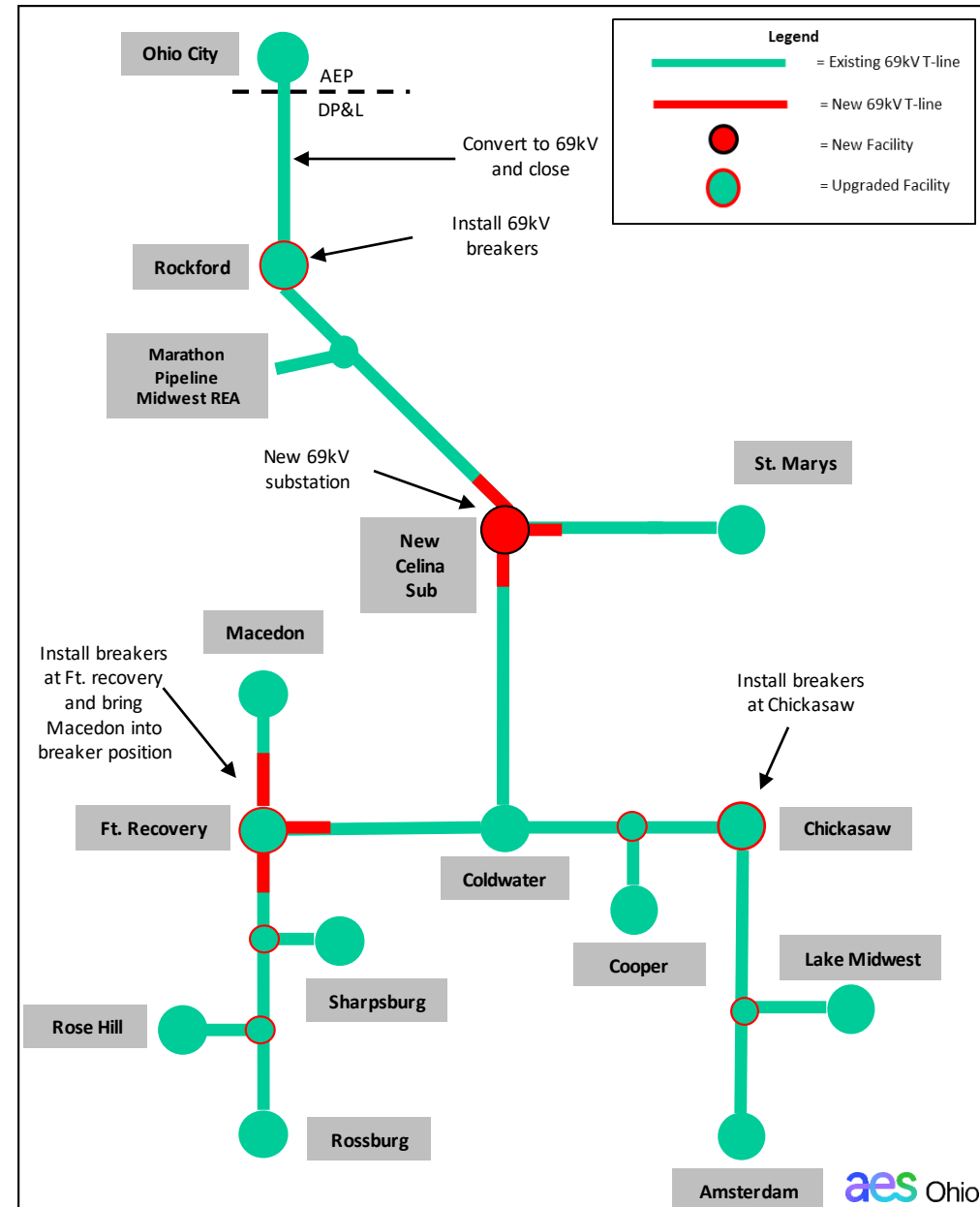

Need Number: Dayton-2020-007

Process Stage: Submission of Supplemental Project for inclusion in the Local Plan 9/7/2021

Previously Presented: Need Meeting 06/19/2020
Solutions Meeting 03/19/2021

Supplemental Project Driver(s): System Configuration Improvements, Operational Performance

Specific Assumption Reference(s): DP&L 2020 RTEP Assumptions, Slide 5

Problem Statement:

- The Bellefontaine-Blue Jacket-Indian Lake 6648 69kV transmission line is a 16 mile three-terminal line located in Logan County, Ohio. The line features wooden cross-arm and post construction designs.
- The 6648 line provides service to customers served at 7 different substations: Indian Lake (DP&L), Huntsville (DP&L), Harrison (Logan REA), HBD Thermoid (DP&L), AGC Automotive (DP&L), Bellefontaine (DP&L), and Blue Jacket (DP&L).
 - A fault on 6648 results in at least a momentary outage on 9 distribution transformers, 35MW of load, and possible sustained outages to the multitude of customers served from the line.
 - Also, an outage on 6648 between the Blue Jacket tap and Harrison (Logan REA) will make the remaining circuit radial that provides service to Honda Transmission (Logan REA) and 10 other points of delivery served from the 6631 line in this configuration.
- The 6648 line has experienced 1 permanent and 3 momentary outages since 2017. The permanent outage was caused by a tree outside of the right of way and the momentary outages were caused by lightning, an issue on the distribution underbuild, and a failed piece of equipment during switching.
- The 6648 line serves approximately 35MW of load and has 16 miles of exposure (560MW-mile), although the line has performed well, there is significant exposure on this circuit that must be reduced to ensure long-term reliability.
- Immediately east of Indian Lake substation, the 6648 line crosses a low-lying area for approximately 0.75 miles. For several months of the year, structures are in standing water.
- Circuit 6906 is a radial line 2.0 mile long radial line connecting Indian Lake to a large industrial load (23 MW).

Model: 2020 RTEP Series, 2025 Summer Case

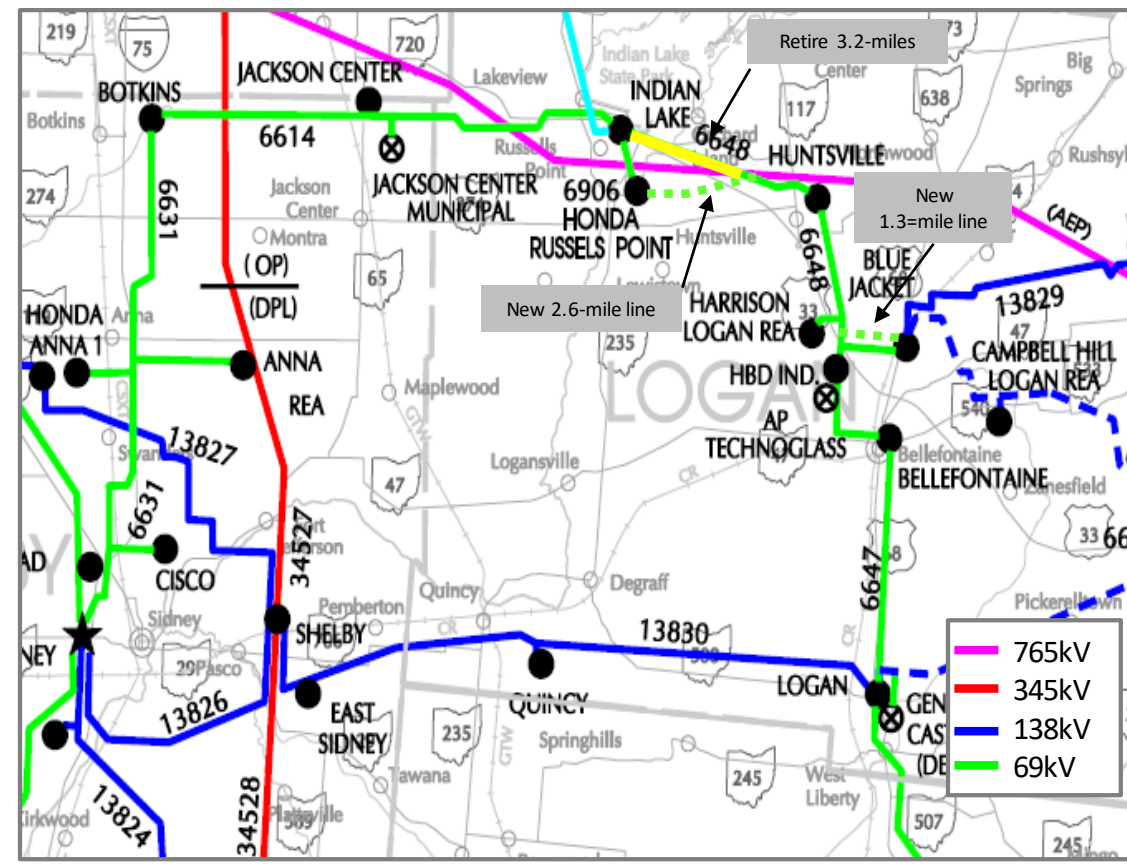
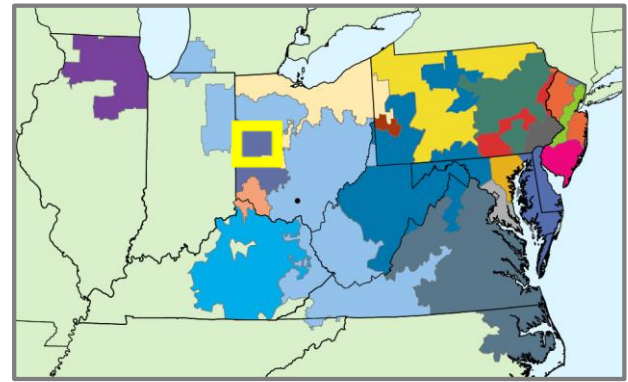

Need Number: Dayton-2020-007

Process Stage: Submission of Supplemental Project for inclusion in the Local Plan 9/7/2021

Proposed Solution:

Indian Lake – Russells Point (HTM) – Blue Jacket: Eliminate the radial configuration currently serving the Honda Russells Point facility by rebuilding and rerouting the Indian Lake 69kV. This project will retire approximately 3.2 miles of the existing 6648 69kV transmission circuit that traverses a floodplain and build a new 2.6-mile single circuit 1351 AAC 69kV line extension from the Honda Russells Point that will loop the radial load and decrease line exposure. **Estimated Transmission Cost: \$4.6M, ISD 12/01/2024 (\$2473.1)**

New Russells Point Substation: Establish a new 69kV substation configured in a four breaker 69kV ring bus arrangement to loop the radial load, reduce line exposure, and reconfigure the area into a more flexible transmission arrangement. **Estimated Transmission Cost: \$3.5M, ISD 12/01/2024 (\$2473.2)**

Blue Jacket Tap: Eliminate the three-terminal line arrangement by extending a new single circuit 69kV 1351 AAC line and looping it in and out of the Blue Jacket substation. The elimination of the tap arrangement will reduce total circuit exposure by 60% and help minimize the impact of line outages by tripping less equipment and will significantly improve the operational flexibility in the area by having two distinct outlets coming out of Blue Jacket to the west. **Estimated Transmission Cost: \$1.4M, ISD 12/01/2024 (\$2473.3)**

Blue Jacket Substation: The 69kV portion of the Blue Jacket Substation will be expanded with three new 69kV breakers to accommodate the new 69kV line termination eliminating the three terminal line configuration. **Estimated Transmission Cost: \$6.4M (\$2473.4)**

Harrison Tap: The switches outside of the Harrison REA Delivery Point will be replaced with a new three-way MOAB with supervisory control to maintain switching flexibility once the Blue Jacket Tap switches are removed. This will ensure Harrison can be picked up in the event of an outage from Russells Point, Blue Jacket, or the DP&L system can separate from Harrison if there are issues on the Logan REA System. **Estimated Transmission Cost: \$0.55M, ISD 12/01/2024 (\$2473.5)**

Huntsville Tap: Install a new 3-way MOAB switch to increase operator flexibility to restore load during contingency conditions. **Estimated Transmission Cost: \$0.55M, ISD 12/01/2024 (\$2473.6)**

Total Transmission Cost: \$17M, ISD 12/01/2024

Projected In-Service: 12/1/2024

Project Status: Conceptual

Model: 2020 RTEP – 2025 Summer Case

Supplemental Project ID: S2473.1-.6

Dayton Transmission Zone M-3 Process Russells Point, Ohio

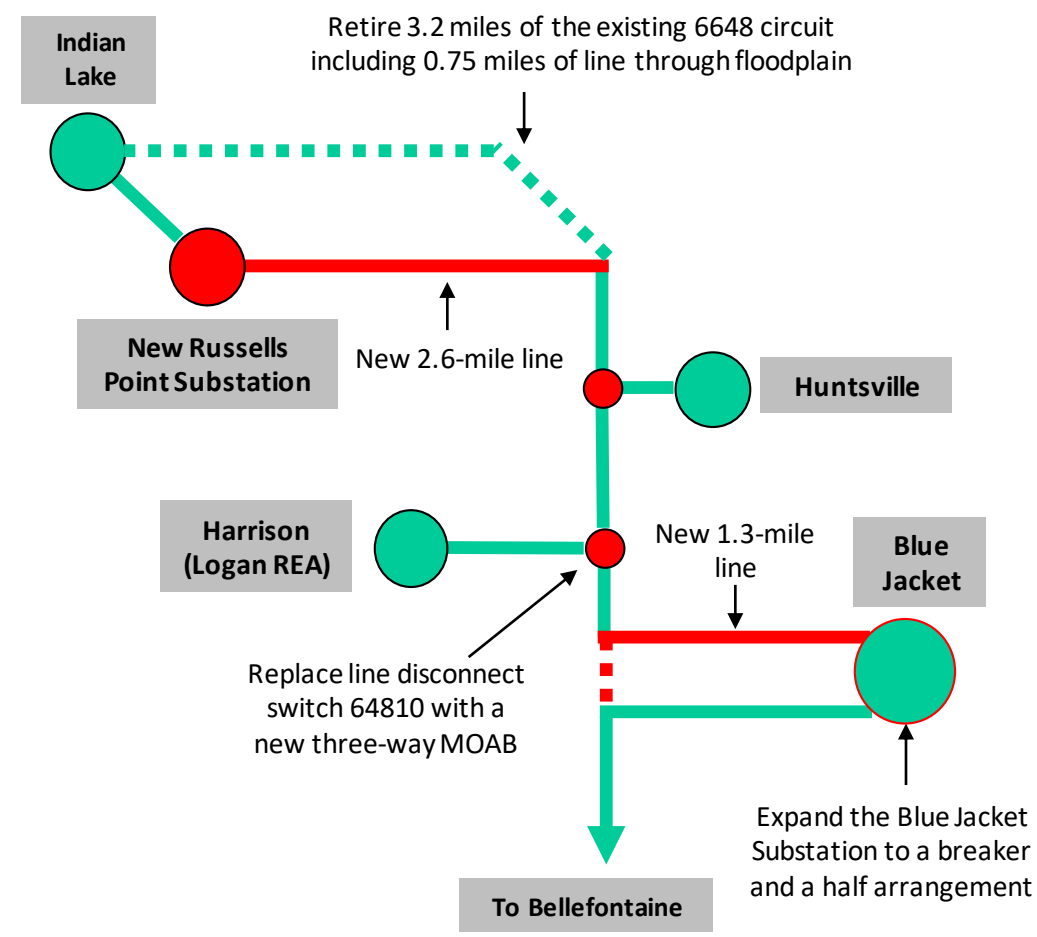

Legend	
	= Existing 69kV T-line
	= New 69kV T-line
	= New Facility
	= Upgraded Facility

Revision History

3/9/2021 – V1 – Added S2398.1-.7 and S2399

3/12/2021 – V2 – Corrected V1 posting date from 2020 to 2021

4/20/2021 – V3 – Added S2423

5/24/2021 – V4 – Added Slides #8-9, S2462.1-.2

5/25/2021 – V5 – Added Slides #10-11, S2461.1-.5

7/12/2021 – V6 – Added Slides #12-13, S2521.1-.6

9/8/2021 – V7 – Added Slides #14-15, S2473.1-.6

10/19/021 – V8 – Slide #3, correct the s# from 2389 to 2398