

PJM Manual 11:

Energy & Ancillary Services Market Operations

Revision: 131

Effective Date: September 1, 2024

Prepared By
Day-Ahead and Real-Time Market Operations

PJM © 2024



Table of Contents

Table of Exhibits	5
Approval	6
Current Revision	7
Introduction	8
About PJM Manuals	8
About This Manual	8
Using This Manual.....	9
Section 1: Overview of Energy & Ancillary Services Market Operations	11
1.1 PJM Responsibilities	12
1.2 PJM Market Participants Responsibilities.....	13
Section 2: Overview of the PJM Energy Markets.....	16
2.1 Overview of PJM Energy Markets	17
2.2 Definition of Locational Marginal Price.....	20
2.3 Energy Market Business Rules	21
2.4 Real-time Market Operations	55
2.5 Real-time Clearing Engines	55
2.6 PJM State Estimator.....	63
2.7 Locational Pricing Calculator (LPC)	63
2.8 The Calculation of Locational Marginal Prices (LMPs) During Emergency Procedures.....	69
2.9 Shortage Pricing.....	70
2.10 PJM Real-time Price Verification Procedure.....	71
2.11 Price-Bounding Violations.....	73
2.12 Calculation of Ramp Limited Desired MWh	73
2.13 Section Retired.....	75
2.14 Balancing Operating Reserve Cost Analysis	75

2.15 Maximum Emergency Generation in Day-ahead Market.....	77
2.16 Minimum Capacity Emergency in Day-ahead Market	77
2.17 Applying Transmission Constraint Penalty Factors in the Market Clearing Engine.....	78
2.18 Applying Stability Limits in the Market Clearing Engine	80
2.19 Notification of a Performance Assessment Interval	80
2.20 Interface Prices	81
Section 3: Overview of the PJM Regulation Market.....	82
3.1 Overview of the PJM Regulation Market	82
3.2 PJM Regulation Market Business Rules	83
Section 4: Overview of the PJM Reserve Market.....	101
4.1 Overview of the PJM Reserve Markets	101
4.2 PJM Reserve Market Offer Business Rules	103
4.3 Reserve Requirement Determination	112
4.4 Reserve Market Clearing	118
4.5 Event Performance	128
4.6 Reserve Obligations	131
4.7 Bilateral Reserve Transactions	132
4.8 Reserve Settlements	132
Section 4b: Section Retired	134
4b.1 Section Retired.....	134
4b.2 Section Retired.....	134
Section 5: Market Clearing Processes and Tools	135
5.1 PJM Scheduling Process	135
5.2 Scheduling Tools.....	137
Section 6: Section Retired	149

Section 7: External Transaction Scheduling	150
7.1 Net Interchange Cap	150
7.2 Overview of the PJM-MISO Coordinated Transaction Scheduling	151
7.3 PJM-MISO Coordinated Transaction Scheduling Business Rules.....	151
Section 8: Posting OASIS Information	154
Section 9: Hourly Scheduling	155
9.1 Hourly Schedule Adjustments	155
9.2 Self-Schedule Adjustments.....	159
Section 10: Overview of the Demand Resource Participation.....	160
10.1 Overview of Demand Resource Participation	160
10.2 Demand Resource Registration Requirements.....	162
10.3 Economic DR Energy Market Participation.....	174
10.4 Demand Resource Metering and Settlement Data Requirements	180
10.5 Aggregation for Economic, Pre-Emergency and Emergency Demand Resources.....	192
10.6 Interval Meter Equipment and Load Data Requirements	194
10.7 Use of Sub-meter Load Data to Support Demand Response Regulation Compliance	195
Section 11: Section Retired	197
11.1 Section Retired.....	197
11.2 Section Retired.....	197
Section 12: Overview of the Price Responsive Demand	198
12.1 Overview of Price Responsive Demand	198
12.2 Price Responsive Demand Business Rules.....	199
Attachment A: Interchange Energy Schedule Curtailment Order..	201
Attachment B: Pumped Storage Modeling	202
Attachment C: Deleted	204



Attachment D: Verification of Offers greater than \$1,000/MWh that were not eligible to set LMP 205

Revision History 207



Table of Exhibits

Exhibit 1: Energy Market Daily	140
Exhibit 2: Settlement Subsystems	142
Exhibit 3: Download Data from Markets Database.....	144
Exhibit 4: Energy Market Data Flow	144



Approval

Approval Date: 12/20/2023
Effective Date: 09/01/2024

Joe Ciabattoni, Sr. Manager

Day-Ahead Market Operations

Brian Chmielewski, Sr. Manager

Real-Time Market Operations

Current Revision

Revision 131 (09/01/2024):

- Conforming changes with addition of Tariff/OA definitions for Synchronous Condensing Costs
 - Section 4.2.5.3: Added clarifying language to conform with Tariff/OA definitions
 - Section 4.4.4: Added clarifying language to conform with Tariff/OA definitions

~~Revision 130 (03/20/2024):~~

- ~~Addition of Interface Prices section (2.20)~~

Introduction

Welcome to the PJM Manual for Energy & Ancillary Services Market Operations. In this Introduction, you will find the following information:

- What you can expect from the PJM Manuals in general (see “About PJM Manuals”).
- What you can expect from this PJM Manual (see “About This Manual”).
- How to use this Manual (see “Using This Manual”).

About PJM Manuals

The PJM Manuals are the instructions, rules, procedures, and guidelines established by PJM for the operation, planning, and accounting requirements of the PJM RTO and the PJM Energy Market. The Manuals are grouped under the following categories:

- Transmission
- PJM Energy Market
- Regional Transmission Planning Process
- Reserve
- Accounting and Billing
- PJM administrative services

For a complete list of all PJM Manuals, go to the Library section on PJM.com.

About This Manual

The PJM Manual for Energy & Ancillary Services Market Operations is one of a series of manuals within the PJM Energy Market Manuals. This manual focuses on the Day-ahead and Real-time scheduling activities that are performed by the PJM staff and the PJM Members. The manual describes the rules and procedures that are followed to schedule resources.

The PJM Manual for Energy & Ancillary Services Market Operations consists of twelve (12) sections. The sections are listed in the table of contents beginning on page 2.

Intended Audience

The intended audience of the PJM Manual for Energy & Ancillary Services Market Operations is:

- *PJM Members* - Any participants requesting to purchase or sell energy to or from the PJM Interchange Energy Market or Ancillary Service Markets and any participant that schedules bilateral sales or purchases.

- *PJM operations staff* - The PJM operations staff that processes the market information and develops the resource schedule.
- *PJM dispatchers* - The PJM dispatchers that process PJM Member requests, make hourly schedule adjustments, and post information in the OASIS.
- *Local Control Center dispatchers* - The Local Control Center dispatchers that submit hourly schedule changes.
- *Local Control Center operations support staff* - The Local Control Center operations support staff that support the Day-ahead and Real-time information requirements.

References

The References to other documents that provide background or additional detail directly related to the PJM Manual for Energy & Ancillary Services Market Operations are:

- PJM ExSchedule User Guide
- PJM Manual for [Transmission Operations\(M-03\)](#)
- PJM Manual for [Financial Transmission Rights \(M-06\)](#)
- PJM Manual for [Pre-Scheduling Operations \(M-10\)](#)
- PJM Manual for [Balancing Operations \(M-12\)](#)
- PJM Manual for [Emergency Operations \(M-13\)](#)
- PJM Manual for [Generator Operational Requirements \(M-14D\)](#)
- PJM Manual for [PJM Capacity Market \(M-18\)](#)
- PJM Manual for [Load Forecasting and Analysis \(M-19\)](#)
- PJM Manual for [Operating Agreement Accounting \(M-28\)](#)
- PJM Manual for [Training and Certification Requirements \(M-40\)](#)

Using This Manual

PJM believes that explaining concepts is just as important as presenting procedures. This philosophy is reflected in the way the material in this Manual is organized. Each section begins with an overview. Then, details, procedures or references to procedures found in other PJM Manuals are presented. The following provides an orientation to the Manual's structure.

What Will Be Found In This Manual

- A table of contents that lists three (3) levels of subheadings within each of the sections.
- An approval page that lists the required approvals and a brief outline of the current revision.
- Sections containing the specific guidelines, requirements, or procedures including PJM actions and Market Participant actions.

- Attachments that include additional supporting documents, forms, or tables in this PJM Manual.
- A section at the end detailing all previous revisions of the PJM Manual.

Section 1: Overview of Energy & Ancillary Services Market Operations

Welcome to the Overview of Energy & Ancillary Services Market Operations of the PJM Manual for Energy & Ancillary Services Market Operations. In this section you will find the following information:

- A description of the scope and purpose of scheduling (see “*Scope & Purpose of Energy & Ancillary Services Market Operations*”).
- A list of the PJM responsibilities (see “*PJM Responsibilities*”).
- A list of the market participants’ scheduling responsibilities (see “*PJM Market Participant Responsibilities*”).

Scope & Purpose of Energy & Ancillary Services Market Operations

Operation of the PJM RTO markets involves many activities that are performed by different operating and technical personnel. These activities occur in parallel on a continuous basis, 24 hours a day and can be grouped into three overlapping time frames:

- pre-scheduling operations
- scheduling operations and the Day-ahead Energy Market
- dispatching and the Real-time Energy Market

In the PJM Manual for Energy & Ancillary Services Market Operations we focus mainly on the activities that take place one day prior to the Operating Day including the activities associated with the Day-ahead Energy Market and in Real-time associated with the Real-time Energy Market and Ancillary Service Markets.

Generation resources, regardless of fuel type, fall into one of two categories, Capacity Resources or Energy Resources. If available, all Generation Capacity Resources that have a Reliability Pricing Model (RPM) or Fixed Resource Requirement (FRR) Commitment must submit offer data into the Day-ahead Market and may elect either to Self-Schedule or offer the resource to PJM for scheduling as a PJM RTO-Scheduled Resource. In this section we focus primarily on the PJM Day-ahead Energy Market and the Reliability Assessment and Commitment (RAC) run process that takes place after the Day-ahead Energy Market is closed.

Scheduling by PJM includes the Day-ahead Energy Market, the RAC run process and the Real-time Energy Market. The Day-ahead Energy Market bid/offer period closes at 11:00 on the day before the Operating Day and the Day-ahead Market results are posted by 13:30 or as soon as practicable thereafter on the day before the Operating Day. The RAC run process occurs throughout the day before the Operating Day. The Real-time Energy Market performs unit commitment and dispatch during the Operating Day. During the scheduling process, PJM:

- Clears the Day-ahead Energy and Reserve Markets using least-cost security constrained resource commitment and dispatch that simultaneously optimizes energy and reserves.

- Determines a plan to reliably serve the hourly energy and reserve requirements of the PJM RTO by minimizing the cost to provide additional operating reserves above what was scheduled in the Day-ahead Market if required.
- Performs Real-time unit commitment and dispatch throughout the Operating Day as required.

PJM Members submit their bids according to either actual cost or offer price as designated by the Operating Agreement of PJM Interconnection, L.L.C. for each generation resource.

In this Manual, Locational Marginal Price (LMP) is defined as the marginal price for energy at the location where the energy is delivered or received. For accounting purposes, LMP is expressed in dollars per megawatt-hour (\$/MWh). In performing this LMP calculation, the cost of serving an increment of load at each bus from each resource associated with an eligible energy offer is calculated as the sum of the following three components of LMP: System Energy Price, Congestion Price, and Loss Price. In this Manual, unless otherwise specified, the terms “LMP” or “Locational Marginal Price” refer to the total LMP value including all three components. For information on the concept of LMPs, please refer to Section 2 of this Manual.

1.1 PJM Responsibilities

In the Day-ahead Market, PJM determines the minimum production cost of satisfying the demand bids, decrement bids, operating reserves, and other ancillary services requirements of the market buyers, including the reliability requirements of the PJM RTO. In addition to the Day-ahead Market scheduling process, PJM also schedules resources to:

- Satisfy the reserve requirements of the PJM RTO by minimizing the cost to provide additional operating reserves above what was scheduled in the Day-ahead Market, if required.
- Provide other ancillary services requirements of the market buyers.
- Satisfy all other reliability requirements of the PJM RTO. Specifically, PJM’s responsibilities to support scheduling activities for all PJM Members include:
 - Develop the Day-ahead Market financial schedules based upon participant-supplied bids, offers and bilateral transaction schedules using least-cost security constrained resource commitment and dispatch analysis.
 - Post the following information after the Day-ahead Market clears:
 - Schedules for Next Day by participant (generation & demand),
 - Transaction Schedules,
 - Day-ahead LMPs, Day-ahead Congestion Prices, & Day-ahead Loss Prices,
 - Day-ahead Binding Transmission Constraints,
 - Day-ahead Net Tie Schedules,
 - Day-ahead Reactive 500 kV Interface Indicator Limits,

- PJM Load Forecast,
 - Aggregate Demand Bids,
 - PJM Day-ahead Reserve commitments.
- Meet the PJM Forecasted load and reserves not covered by the Day-ahead demand bids, Self-Scheduled Resources or Bilateral Transactions, including scheduling generation to relieve expected transmission constraints.

In addition to resource scheduling PJM is also responsible to:

- Maintain data and information related to generation facilities in the PJM RTO as may be necessary to conduct the scheduling and dispatch of the PJM Interchange Energy Market and PJM RTO.
- Post the updated forecast of PJM Load and of the location and duration of any expected transmission congestion between areas in the PJM RTO.
- Revise schedule of resources to reflect updated projections of load, changing Bulk Electric System conditions, availability of and constraints of limited energy and other resources.
- Notify PJM stakeholders of any new closed loop interface implementation as far in advance as possible with a target notice of five (5) days prior to the next Financial Transmission Rights (FTR) auction close. Notification is communicated through posting on www.pjm.com – OASIS System Information and e-mail to the MIC and OC email distribution lists. Exceptions to this are limited to estimated short duration planned, emergency or maintenance outages, (e.g., < ten (10) days) to set price, or to allow Demand Response (DR) to set price if a transmission limitation exists as defined in the PJM Tariff and Manuals. The posting will include the interface name, effective date, estimated termination date (if applicable), whether included in Day-ahead model, whether included in the FTR model, conditions when use is applicable, general description, interface definition/branch names and directions, whether it will set price for DR, generation, or both and any revision history. PJM will post an interface definition with network model map-able branch names in CSV or XLS format. In addition PJM will provide notice when PJM is studying if a new closed loop interface may be defined and any information regarding the modeling of such prospective closed loop interface.

1.2 PJM Market Participants Responsibilities

Only PJM Members are eligible to submit offers and purchase energy or related services in the Day-ahead Energy Market and in the Real-time Energy Market. PJM Members include Market Buyers and Market Sellers.

1.2.1 Market Buyers

There are two general types of Market Buyers:

- *Metered Market Buyer* – A Metered Market Buyer is a buyer that is purchasing energy from the PJM Interchange Energy Market for consumption by end-users inside the PJM RTO. A

Metered Market Buyer may be further classified as a Generating Market Buyer. A Generating Market Buyer is a Metered Market Buyer that owns or has contractual rights to the output of generation resources that are capable of serving the Market Buyer's load in the PJM RTO or selling energy-related services in the PJM Interchange Energy Market or elsewhere.

- The scheduling responsibilities of a Metered Market Buyer are to:
 - Submit forecasts of customer loads for the next Operating Day.
 - Submit economic load management agreements to PJM.
 - Submit Bilateral Transactions for delivery within the PJM RTO, regardless of whether the generation is located inside or outside the PJM RTO.
- *Unmetered Market Buyer* – An Unmetered Market Buyer is a Market Buyer that is making purchases of energy from the PJM Interchange Energy Market for consumption by metered end-users or end-users that are located outside the PJM RTO.
 - The scheduling responsibilities of an Unmetered Market Buyer are to:
 - Submit optional requests to purchase specified amounts of energy for each hour of the Operating Day during which it intends to purchase from the PJM Day-ahead Energy Market, along with Dispatch Rates (i.e. price-sensitive Demand Bids) above which it does not desire to purchase, if desired.
 - Purchase a transmission capacity reservation in order to receive generation from the PJM Interchange Energy Market if the energy is being delivered to end-users that are located outside the PJM RTO.

By definition, all Market Buyers become Market Sellers upon approval of their applications and therefore carry the responsibilities of Market Sellers outlined below.

1.2.2 Market Sellers

A Market Seller is a PJM Member that demonstrates to PJM that it meets the standards for the issuance of an order mandating the provision of transmission service under Section 211 of the Federal Power Act, submits an application to PJM that is approved in accordance to the procedures specified in PJM Manual 33: Administrative Services for the PJM Interconnection Operating Agreement.

The scheduling responsibilities of a market seller include:

- Submit hourly schedules for Self-Scheduled Resource increments.
- Submit a forecast of the availability for the next seven days for each Generation Capacity Resource committed to RPM or FRR.
- Submit Offer Data for Generation Capacity Resources committed to RPM or FRR for the supply of energy to the PJM Day-ahead Energy Market for the next day whether Self-Scheduled or PJM scheduled.

- Submit schedules for bilateral sales to entities outside the PJM RTO from within the PJM RTO.
- Submit optional offers for the supply of energy, capacity, and other ancillary services from Energy Resources into the Day-ahead Energy Market or the Real-time Energy Market for the next operating day only.

1.2.3 Load Serving Entities

A Load Serving Entity (LSE) is any entity that has been granted authority or has an obligation pursuant to state or local law, regulation, or franchise to sell electric energy to end-users that are located within the PJM RTO. An LSE may be a Market Buyer or a Market Seller, as described above.

1.2.4 Curtailment Service Providers

A Curtailment Service Provider is a Member or Special Member, which acting on behalf of itself or one or more other Members or non-Members, participates in the PJM Interchange Energy Market by causing a reduction in demand.

Section 2: Overview of the PJM Energy Markets

Welcome to the Overview of the PJM Energy Markets section of the PJM Manual for Energy & Ancillary Services Market Operations. In this section you will find the following information:

- An overview description of the PJM Energy Markets (see “Overview of PJM Energy Markets”).
- The definition of Locational Marginal Price (see “Definition of Locational Marginal Price”).
- A list of the Energy Market Business Rules applicable to Market Buyers and Market Sellers (see “PJM Energy Market Business Rules”).
- A description of the PJM Real-time Locational Marginal Price calculation process (see “Real-time Locational Marginal Price (LMP) Calculations”).
- A description of the various Real-time Market Clearing Engines that optimize the various products on a 5-minute basis (see “Real-time Market Clearing Engines”).
- A description of the PJM State Estimator and its use in Real-time market Operations (see “PJM State Estimator”).
- A description of the Locational Pricing Calculator, including its function and purpose (see “Locational Pricing Calculator (LPC”).
- The process to calculate LMPs during Emergency Procedures (see “The Calculation of Locational Marginal Prices (LMPs) During Emergency Procedures”).
- The process to calculate LMPs during Reserve Shortages (see “The Calculation of Locational Marginal Prices (LMPs) During Reserve Shortages”).
- A description of the PJM Real-time Locational Marginal Price verification procedure (see “PJM Real-time Locational marginal Price Verification Procedure”).
- A description of the process to validate Locational Marginal Prices (see Price-Bounding Violations”).
- A description of the calculation of Ramp-Limited Desired MWh used to determine whether a unit is following PJM dispatch instructions (see “Calculation of Ramp Limited Desired MWh”).
- A description of how Locational Marginal Prices (LMPs) are calculated and how they are used in market settlements (see “Use of Locational Marginal Prices in Market Settlements”).
- A description of the analysis performed to determine eligibility for Balancing Operating Reserves (see “Balancing Operating Reserve Cost Analysis”).
- A description of when a Maximum Generation Warning can be issued in the Day-ahead Market (see “Maximum Emergency Generation in Day-ahead Market”).
- A description of when a Minimum Generation Warning can be issued in the Day-ahead Market (see “Minimum Capacity Emergency Generation in Day-ahead Market”).

- A description of how Transmission Constraint Penalty Factors are used in Market Clearing Engines (see “Applying Transmission Constraint Penalty Factors in Market Clearing Engines”).
- A description of the process to apply active stability limitations impacting generation resources (see “Applying Stability Limits in the Market Clearing Engine”).

2.1 Overview of PJM Energy Markets

The PJM Energy Markets consists of two markets, a Day-ahead Market and a Real-time Balancing Market. In general, both markets follow a two-step process to perform dispatch and pricing of the system. First, security-constrained economic dispatch of the system is performed, referred to as the dispatch run. Second, the calculation of Locational Marginal Prices is performed separately and subsequent to the dispatch run, referred to as the pricing run. The objective of both the dispatch run and the pricing run is to serve load and meet reserve requirements at the least cost while evaluating the same transmission constraints.

In the pricing run, however, Integer Relaxation is performed to allow Eligible Fast-Start Resources that are online in the dispatch run, to set price as well as to incorporate their associated commitment costs. Integer Relaxation allows Eligible Fast-Start Resources that generally do not have wide dispatchable ranges to be fully dispatchable between zero and their Economic Maximum. Resources cannot be committed in the pricing run if they were not committed in the dispatch run. This in turn allows the optimization problem in the pricing run to use a fraction of a committed Eligible Fast-Start Resource’s output, including an amount less than the resource’s offered economic minimum output, in the determination of Locational Marginal Prices.

2.1.1 Fast-Start Capable Resources

Fast-Start Resources are generation or Economic Load Response Participant Resources that are capable of operating with a notification time plus startup time of one hour or less and a Minimum Run Time of one hour or less or minimum down time of one hour or less. The following unit types are deemed capable of operating as Fast Start Resources by default:

- Fuel Cells
- CTs
- Diesels
- Hydro
- Battery
- Solar
- Landfill
- Wind
- Hybrid Resource

- Economic Load Response

2.1.2 Fast-Start Capable Adjustment Process

The Market Seller of a resource not considered a Fast-Start Resource may seek approval to be considered a Fast-Start Resource by submitting a written request to PJM and the Market Monitoring Unit (MMU). The request must include documentation to support the resource's capability of operating with a notification time plus startup time of one hour or less and a Minimum Run Time of one hour or less or Minimum Down Time of one hour or less based on its operating characteristics, such as historical operating data showing the ability to provide energy upon an hour's notice.

PJM, the Market Seller, and the MMU will review the information and documentation in support of the request in an open and transparent manner. Market Sellers must submit the request, and supporting documentation, by April 15. PJM will determine, with the advice and input of the MMU, whether the resource will be considered Fast-Start capable and provide written notification to the Market Seller of the determination no later than May 31. If the request is granted, the resource will be considered a Fast-Start Resource as of June 1 of that calendar year. If the request is denied, PJM will include a written explanation for the denial. Requests and questions may be submitted by Market Participants to FastStartCapable@pjm.com.

If a Fast-Start Resource persistently fails to provide energy or load reduction consistent with the required offer parameters defined in Section 2.1.1 PJM may deem, in consultation with the MMU, that the resource is no longer considered a Fast-Start Resource. In that event, written notification, including a written explanation, will be provided by PJM to the Market Seller. A resource may regain Fast-Start Resource status based on the adjustment process outlined above.

2.1.3 Eligible Fast-Start Resources

A Fast-Start Resource shall be an Eligible Fast-Start Resource when the following apply:

1. A generation resource is committed on an offer with a notification time plus startup time of one hour or less and a Minimum Run Time of one hour or less.
2. An Economic Load Response Participant resource is committed on an offer with a notification time of one hour or less and a Minimum Down Time of one hour or less.
3. The resource shall not be any of the following:
 - a. Self-scheduled for Energy in a given interval;
 - b. A pumped storage hydropower unit scheduled by PJM pursuant to the hydro optimization tool in the Day-ahead Energy Market;
 - c. A pseudo-tied resource that does not provide all of their output to PJM; or
 - d. A dynamically scheduled resource.

Only Eligible Fast-Start Resources shall have Integer Relaxation applied in the calculation of Locational Marginal Prices in the pricing run.

2.1.4 Day-ahead Energy Market

The Day-ahead Energy Market is a forward market in which hourly clearing prices are calculated for each hour of the next operating day based on generation offers, demand bids, increment offers, decrement bids and bilateral transaction schedules submitted into the Day-ahead Energy Market.

The Day-ahead Energy Market enables participants to purchase and sell energy at binding Day-ahead LMPs.

- It also allows transmission customers to schedule bilateral transactions at binding Day-ahead congestion charges based on the differences in the Congestion Prices between the transaction source and sink.
- Load Serving Entities (LSEs) may submit hourly demand schedules, including any price sensitive demand, for the amount of demand that they wish to lock-in at Day-ahead prices.
- Any generator that is a PJM generation capacity resource that has a Reliability Pricing Model (RPM) or Fixed Resource Requirement (FRR) Resource Commitment must submit a bid schedule into the Day-ahead Energy Market even if it is self-scheduled or unavailable due to outage. Other generators have the option to bid into the Day-ahead Energy Market.
- Transmission customers may submit fixed, dispatchable or 'up to' congestion bid bilateral transaction schedules into the Day-ahead Energy Market and may specify whether they are willing to pay congestion charges or wish to be curtailed if congestion occurs in the Real-time Energy Market.
- Curtailment Service Providers (CSPs) may submit demand reduction bids.

After the daily quote period closes, PJM calculates the Day-ahead schedule based on the bids, offers and schedules submitted, using the scheduling programs described throughout Section 5 of this Manual, based on least-cost, security constrained resource commitment and dispatch for each hour of the next operating day. The Day-ahead scheduling process incorporates PJM reliability requirements and reserve obligations into the analysis. The resulting Day-ahead hourly schedules, generated by the dispatch run, and Day-ahead LMPs, generated by the pricing run, represent binding financial commitments to the market participants.

The Day-ahead Market settlement is calculated for each Day-ahead Settlement Interval (hourly interval) based on scheduled hourly quantities resulting from the dispatch run and on Day-ahead hourly prices resulting from the pricing run.

2.1.5 Real-time Energy Market

The Real-time Energy Market uses the Real-time Security Constrained Economic Dispatch (RT SCED) program, known as the dispatch run, to determine the least cost solution to balance

supply and demand. The dispatch run considers resource offers, forecasted system conditions, and other inputs in its calculations. For more information regarding the RT SCED program, please refer to Section 2.5 of this Manual. Generators and Demand Resources may alter their bids for use in the Real-time Energy Market as defined in Section 9.1 of this Manual during the following periods:

- During the Generation Rebidding Period which is defined from the time PJM posts the results of the Day-ahead Energy Market until 14:15.
- Starting at 18:30 (typically after the Reliability Assessment and Commitment (RAC) Run is completed) and up to sixty-five (65) minutes prior to the start of the operating hour.

Real-time LMPs and Regulation and Reserve Clearing Prices are calculated every five (5) minutes by the Locational Price Calculator (LPC) program, in a process referred to as the pricing run, and are based on forecasted system conditions and the latest approved RT SCED program solution. For more information regarding LPC, Real-time LMPs and Regulation and Reserve Clearing Prices, refer to Section 2.7 of this Manual.

The balancing settlement is calculated for each Real-time Settlement Interval (five (5) minute interval) based on actual five (5) minute Revenue Data for Settlement MW quantity deviations from Day-ahead scheduled quantities resulting from the dispatch run and on the applicable Real-time prices resulting from the pricing run.

2.2 Definition of Locational Marginal Price

Locational Marginal Price (LMP) is defined as the marginal price for energy at the location where the energy is delivered or received and is based on forecasted system conditions and the latest approved Real-time security constrained economic dispatch program solution. LMP is expressed in dollars per megawatt-hour (\$/MWh). LMP is a pricing approach that addresses Transmission System congestion and loss costs, as well as energy costs. Therefore, each spot market energy customer pays an energy price that includes the full marginal cost of delivering an increment of energy to the purchaser's location.

- When there is transmission congestion in PJM, the PJM dispatcher dispatches one or more of the generating units out of economic merit order to keep transmission flows within limits. There may be many resources that are dispatched to relieve the congestion. The LMP reflects the cost of re-dispatch for out-of-merit resources and cost of delivering energy to that location.
- LMPs are calculated at all injections, withdrawals, EHV's (nominal voltage of 500 KV and above), Interfaces, and various aggregations of these points.
- LMPs are calculated in both the Real-time Energy Market and Day-ahead Energy Market.
 - The Day-ahead LMP is calculated based on the security-constrained economic dispatch for the Day-ahead Market as described in Section 5.2.6 of this Manual.

- The Real-time LMP is calculated based on the approved security constrained economic dispatch solution for the target dispatch interval as described in Section 2.7 of this Manual.
- The LMP calculation determines the full marginal cost of serving an increment of load at each bus from each resource associated with an eligible energy offer as the sum of three (3) separate components of LMP. In performing this LMP calculation, the cost of serving an increment of load at each bus from each resource associated with an eligible energy offer is calculated as the sum of the following three components of Locational Marginal Price:
 - System Energy Price – This is the price at which the Market Seller has offered to supply an additional increment of energy from a generation resource or decrease an increment of energy being consumed by a Demand Resource. The System Energy Price may include a portion of the defined reserve penalty factors should a reserve shortage exist.
 - Congestion Price – This is the effect on transmission congestion costs (whether positive or negative) associated with increasing the output of a generation resource or decreasing the consumption by a Demand Resource, based on the effect of increased generation from or consumption by the resource on transmission line loadings. As further described in Section 2.17 of this Manual, the Congestion Price is set to the specified transmission constraint penalty factor in the event a transmission constraint cannot be controlled below the penalty factor value. The Congestion Price may include a portion of the defined reserve penalty factors should a reserve shortage exist.
 - Loss Price – This is the effect on transmission loss costs (whether positive or negative) associated with increasing the output of a generation resource or decreasing the consumption by a Demand Resource, based on the effect of increased generation from or consumption by the resource on transmission losses.
- The energy offer or offers that can serve an additional increment of load at a bus at the lowest cost, calculated in this manner, shall determine the Locational Marginal Price at that bus.

For full details on how LMPs are utilized in Markets Settlements please refer to Manual 28: Operating Agreement Accounting.

2.3 Energy Market Business Rules

2.3.1 Bidding & Operations Time Line

The Day-ahead scheduling/bidding timeline for PJM Energy Markets consists of the following time frames:

- **11:00** — Day-ahead Market bid period closes. All bids and offers must be submitted to PJM. At 11:00 PJM begins to run the Day-ahead Market Clearing Engine to determine the hourly commitment schedules and the LMPs for the Day-ahead Market. The Day-ahead

clearing results in the resource commitment profile that satisfies the fixed demand, cleared price-sensitive demand bids, cleared demand reduction bids, and PJM Day-ahead Reserve objectives, while minimizing the total production cost (subject to certain limitations) for energy and reserves. This commitment analysis also includes external bilateral transaction schedules and external resource offers into the PJM Day-ahead Market.

- **Prior to 13:30** – PJM posts the Day-ahead hourly schedules and LMPs in the Markets Gateway System. PJM also makes these results available in downloadable files, via the Markets Gateway System, or a dedicated communication link.
- **After Day-ahead Results posting up until 14:15** — PJM opens the Real-time Energy Market offer period. During this time, market participants can submit revised resource offers. However if the market participant self-scheduled their unit in the Day-ahead Market, they cannot change the unit status to economic in the rebid period.
- **14:15 –The Real-time Energy Market offer period closed.** PJM performs a second resource commitment known as the Reliability Assessment and Commitment (RAC) Run, which includes the updated offers, updated resource availability information and updated PJM load forecast information and load forecast deviation. The focus of this commitment is reliability and the objective is to minimize startup and no load costs for any additional resources that are committed.
- **14:15-Operating Day** — PJM may perform additional resource commitment runs, as necessary, based on updated PJM load forecasts and updated resource availability information. PJM sends out individual generation schedules updates to specific generation owners only, as required.
- **18:30-Operating Day** – Starting at 18:30 (typically after the Reliability Assessment and Commitment Run completes) and up to sixty-five (65) minutes prior to the operating hour, revised resource offers may be submitted to PJM.

2.3.2 Market Buyers

The following business rules apply to Market Buyers:

- Up-to congestion bids, increment offers, and decrement bids shall be supported in the Day-ahead Market only.
- A Market Buyer that is not an LSE or purchasing on behalf of an LSE is not required to purchase transmission service for purchases from the PJM Market to cover deviation from its sales in the Day-ahead Market.
- If a Market Buyer submits no Day-ahead bid information, then a zero MW quantity is assumed.
- Participants can submit PRD Curves per business rules in Section 12 of this Manual.

2.3.2.1 Fixed and Price Sensitive Demand Bid Business Rules

- The list of transmission zones, aggregates, and single buses at which demand bids are accepted is defined by PJM.
- Each Market Participant's profile (which is defined by PJM) shall specify the transmission zones or aggregates for which that participant is eligible to submit demand bids.
- Market Buyers may submit hourly demand quantities for which it commits to purchase energy at Day-ahead prices for consumption in the next Operating Day. Quantity bids must specify MW quantity and location (transmission zone, aggregate, or single bus).
- Demand bids are assumed to exclude losses (transmission zone losses and share of 500 kV losses).
- Price sensitive demand bids shall specify MW quantity, location (transmission zone, aggregate, or single bus), and the price at which the demand shall be curtailed.
- Price sensitive demand bids are accepted in single bid blocks only (One (1) Megawatt point with a corresponding price point only).
- Price sensitive demand bids may be submitted with a bid price of no greater than \$2,000/MWh plus the sum of the applicable Primary Reserve and Synchronized Reserve Penalty Factors from the first step of the demand curve not to exceed \$3,700/MWh.
- PJM shall apply Demand Bid screening to all Demand Bids submitted in the Day-ahead Energy Market for each LSE, separately by Zone. PJM automatically rejects a LSE's Demand Bids if the total MW volume of such bids exceeds the LSE's Demand Bid limit for any hour in such Operating Day.
- On a daily basis, PJM updates and posts each LSE's Demand Bid Limit in each applicable Zone. Such Demand Bid Limit applies to all Demand Bids submitted by that LSE for each future Operating Day for which it submits bids.
- The Demand Bid Limit is calculated using the following equation:

$$\text{Demand Bid Limit} =$$

*greater of (Zonal Peak Demand Reference Point * 1.3), or (Zonal Peak Demand Reference Point + 10MW)*

Where:

Zonal Peak Demand Reference Point	for each Zone: the product of (a) LSE's Recent Load Share, multiplied by (b) Peak Daily Load Forecast.
LSE's Recent Load Share	is the LSE's highest share of Network Load in each Zone for any hour over the previous seven (7) Operating Days.
Peak Daily Load Forecast	is PJM's highest available peak load forecast for each applicable Zone that is calculated on a daily basis.

- PJM may allow a LSE to submit bids in excess of its Demand Bid Limit when circumstances exist that cause, or are reasonably expected to cause, a LSE's actual load to exceed its Demand Bid Limit on a given Operating Day. Examples of such circumstances include, but are not limited to, changes in load commitments due to state sponsored auctions, mergers and acquisitions between PJM Members, and sales and divestitures between PJM Members.
- A LSE whose Demand Bids are rejected as a result of Demand Bid screening may change the Demand Bids to reduce the total megawatt volume to a level that does not exceed the Demand Bid Limit. Re-submissions must occur prior to Market closing for the Operating Day.
- Price-sensitive demand can set LMP in the Day-ahead Market.

2.3.2.2 Increment and Decrement (Virtual) Bid Business Rules

- Market Buyers and Market Sellers may submit increment offers or decrement bids at any hub, node at which physical generation or load is settled, Residual Metered Load node and interface point not described in Tariff Attachment K – Appendix, Section 2.6(A)(b). The eligible bidding locations are posted at <https://www.pjm.com/markets-and-operations/energy.aspx>.
- Energy market transactions, except generation resource offers and price sensitive demand bids, may be submitted with an energy bid/offer price of no greater than \$2,000/MWh.
- PJM may require that a Market Participant shall not submit in excess of 3000 virtual bid/offer segments in the Day-ahead Energy Market, when PJM determines that such limit is required to avoid or mitigate significant system performance problems related to the volume of virtual bids.

2.3.2.3 Up-to Congestion Transaction Business Rules

- 'Up-to' congestion bids shall be no greater than \$50/MWh, and no less than -\$50/MWh. Any 'Up-to' congestion transaction that bids higher than \$50/MWh or less than -\$50/MWh will be rejected.
- PJM will maintain an up-to date list of source/sink combinations that will be available for 'Up-to' congestion bidding. The eligible 'Up-to' bidding locations are posted at <https://www.pjm.com/markets-and-operations/energy.aspx>.
- 'Up-to' congestion bids are cleared based on the total LMP price difference between the source and the sink.
- PJM may require that a Market Participant shall not submit in excess of 3000 'Up-to' congestion transactions in the Day-ahead Energy Market, when PJM determines that such limit is required to avoid or mitigate significant system performance problems related to the volume of transactions.

2.3.2.4 Electric Distribution Company (EDC) Activities

- For the Day-ahead Market, the Electric Distribution Company (EDC) shall specify the transmission zone, bus distributions, and aggregate bus distributions as a daily distribution. The default distribution for a transmission zone for the Day-ahead Market is the state estimator distribution for that zone for each corresponding hour of the Operating Day one week prior (i.e. if operating hour is Monday at 08:00, the default distribution is from 08:00 on Monday of the previous week). The default distribution for a residual metered load aggregate for the Day-ahead Market is the final Real-time distribution factors for the residual metered load aggregate for each corresponding hour of the Operating Day one week prior. See PJM Manual 28: Operating Agreement Accounting, Section 3 for additional details on residual metered load aggregates.
- The EDC may update the default distribution factors for a transmission zone only after the state estimator populates the default.
- EDCs shall submit a forecast of demand within their transmission zone. This is for reliability purposes only (and does not, therefore, require a binding bid).

2.3.3 Market Sellers

The following business rules apply to Market Sellers whether or not the resource is a Capacity Resource:

- Market Sellers can choose to self-schedule their generation into the Day-ahead Market or submit an offer into the Day-ahead Market and allow PJM to schedule their generation.
 - Hybrid Resources and resources enrolled in the Energy Storage Resource (ESR) participation model may self-schedule only. When self-scheduling ESR or Hybrid Resources with a storage component, Market Sellers must specify the hourly mode of operation as described in Sections 2.3.4B and 2.3.4C of this Manual and an operating range as described in Section 2.3.3.2 of this Manual.

- Self-scheduled generation shall submit an hourly operating range and can offer an associated price/MW pair for consideration in dispatch.
- Generation owners planning to run generation resources scheduled in the Day-ahead Market are required to call the PJM Control Center at least twenty (20) minutes prior to bringing the resource online. Generation owners of self-scheduled generation resources must also provide at least twenty (20) minutes notice.
 - Hybrid Resources and resources enrolled in the ESR participation model with greater than ten (10) Megawatts must contact the PJM Control Center prior to changing its mode of operation with at least twenty (20) minutes notice.
- Generation resources that are scheduled in the Day-ahead Market have a financial obligation to sell their output in Real-time.
 - Combustion Turbines that are scheduled in the Day-ahead Market and then not called on in Real-time by PJM may be eligible for Credits for Canceled Pool- Scheduled Resources as defined in Section 5.2.4 of PJM Manual 28: Operating Agreement Accounting.
- Generation resources that are committed by PJM in advance of the Day-ahead Energy Market will be offer capped and committed on the applicable available schedule at the time of the commitment. The cost-based schedule made available must follow the Generation Owner's Fuel Cost Policy as defined in PJM Manual 15: Cost Development Guidelines.
- If a generation resource is scheduled in the Day-ahead Market and wishes to deviate from that schedule (i.e. not run), the generation owner should contact the PJM Master Coordinator to determine if this course of action is possible. The PJM Master Coordinator will either:
 - Determine that the generation resource is not needed for reliability purposes for the Operating Day and therefore, the generation owner can decide not to run the resource and no forced outage is incurred. The generation owner is responsible for all deviation and operating reserve charges.
 - Determine that the resource is needed for reliability purposes and therefore, will inform the generation owner. The generation owner may still elect to not run the resource, but a forced outage for the duration of the scheduled operation of the resource is generated. The generation owner is responsible for all deviation and operating reserve charges.
- The timing guideline for notifying PJM of deviations for pool scheduled resources is the sum of the resource's notification time plus the time to start. If this sum totals to zero, then the minimum notification time is forty-five (45) minutes prior to the scheduled operation of the resource. This allows PJM adequate time for determining if the resource is needed for reliability.

The following bullets describe the treatment of generation offers made into the Day-ahead and Real-time Energy Markets:

- Energy resources (i.e. non-Capacity Resources) may offer into the Day-ahead Market or Real-time Market.
- If an Energy resource does not submit offer data, then the offer is assumed to be a zero MW quantity.
- A generator offer that is accepted for the Day-ahead Market automatically carries over into the Real-time market, unless superseded by a subsequent update.
- Any generator that was not selected in the Day-ahead Market may choose to self-schedule during the Rebid Period.
- Market Sellers with Market-based Rate Authority may elect to offer their generation resources as price-based resources. PJM must be notified of this election so that Markets Gateway can be configured to accept price-based offers for the selected resource. Once a Market Seller elects to offer a resource as a price-based resource, they may not change it back to a cost-based resource.

2.3.3.1 Capacity Resource Offer Rules:

- Generators that are Capacity Resources and have an RPM or FRR commitment for the next Operating Day shall submit offers into the Day-ahead Market, even if they are unavailable due to forced, planned, or maintenance outages.
- Generators that are Capacity Resources and have an RPM or FRR commitment for the next Operating Day and are self-scheduling shall submit offer data in the event that they are called upon during emergency procedures. Such offers shall be based on the ICAP equivalent of the cleared UCAP capacity commitment.
- Generation Capacity Resources that have an RPM or FRR commitment shall submit a schedule of availability for the next seven (7) days and may submit non-binding offer prices for the days beyond the next Operating Day.
- Generation Capacity Resources that have notification or startup times that exceed twenty-four (24) hours must submit binding price-based offer prices for the next seven (7) days.
- The set of offer data last submitted for each Generation Capacity Resource shall remain in effect for each day until specifically superseded by subsequent offers; however, cost-based incremental energy offers above \$1,000/MWh shall be capped at \$1,000/MWh when automatically carried forward to subsequent Operating Days.
- If a Generation Capacity Resource is not scheduled in the Day-ahead Market, it may revise its offer and submit into the Real-time Market or it may self-schedule the resource.
- Generation Capacity Resources that have notification plus startup times that exceed twenty-four (24) hours and have been called on by PJM dispatch in advance of the close of the Day-ahead Market bid period for the desired Operating Day must modify their notification and startup time prior to the close of the market bid period for that day in order to create the possibility for the unit to be committed in the Day-ahead Market.
- Intermittent Generation Resources, Hybrid Resources and Capacity Storage Resources that are committed Capacity Resources shall meet the must offer requirement by either

self-scheduling (Availability = Must Run) or may allow the Day-ahead Market to schedule by offering the unit as a dispatchable resource (Availability = Economic) equal to the level defined below.

- Intermittent Generation Resources meet their must offer requirement by offering Economic Maximum MW equal to or greater than their hourly forecast. If the Market Seller develops or procures forecast with different confidence levels, the Market Seller must use the one closest to the median value (e.g. P50). Forecasts can be adjusted to account for expected equipment availability. If the Market Seller does not have a forecast or has technical issues developing or receiving a forecast, the PJM developed forecast is available.
- Hybrid Resources and resources enrolled in the ESR participation model shall meet the must offer requirement by self-scheduling only.
- The hourly Day-ahead self-scheduled values for Intermittent Resources, Hybrid Resources and Capacity Storage Resources may vary hour to hour from the capacity obligation value.
- Hydropower resources fall under the Intermittent Generation Resource category. Hydropower resources that are committed Capacity Resources, shall meet the must offer requirement by self-scheduling (Availability = Must Run).
- Pumped Storage Hydropower resources that are committed Capacity resources, shall meet the must offer requirement by either self-scheduling or may allow the Day-ahead Market to schedule by using the pumped storage optimization model, referred to in Attachment B of this Manual. They may also use the Energy Storage (ESR) Participation Model referred to in Section 2.3.4 of this Manual.

2.3.3.2 Generator Schedules

- Generation schedules are collections of generator parameter operating limits and offer data. There are three (3) types of schedules that can be submitted:
 - Cost-based schedule: Cost-based schedules must comply with limits placed on certain parameters as defined in Section 2.3.4 of this Manual. In addition, generation resource cost-based energy offers must be developed in accordance with Manual 15: Cost Development Guidelines and PJM's governing documents.
 - Price-based Parameter Limited Schedule (PLS): Price-based PLS schedules must comply with limits placed on certain parameters as defined in Section 2.3.4 of this Manual. Price-based PLS energy offers may be market-based.
 - Price-based schedule (non-PLS): Non-PLS Price-based schedules are not subject to the parameter limits defined in Section 2.3.4 of this Manual and may submit market-based energy offers.
 - Note: For purposes of this Manual, price-based is used interchangeably with market-based.
- Each Generation Capacity Resource with an RPM or FRR commitment must make available into the Day-ahead and Real-time Markets:
 - At least one cost-based schedule

- Price-based units must also make available a price-based Parameter Limited Schedule (PLS).
- All price-based units have the option of submitting a second price schedule that is not parameter limited.
- Each Energy Resource that offers into the Day-ahead and Real-time Markets must make available:
 - At least one cost-based schedule
 - Price-based units must also make available a price-based schedule and/or a price-based Parameter Limited Schedule (PLS).
- A generator offer for a generating unit with combined cycle capability shall make available either the schedules for the CTs or the schedule for the combined cycle unit, not both. Only CTs may submit weather curves, which specify MW limits for CTs as a function of temperature.
 - Forecast points shall consist of a daytime temperature and a nighttime temperature.
 - There are separate weather curves for economic MW and for emergency MW.
- Each CT is assigned to a weather point, which is entered by the Operating Company. As generating units change ownership it may be necessary to add weather points. The default for the weather points is the PJM temperature forecast.

Operating Limit Business Rules

- The priority of generator offer operating limits are as follows: (1) Unit Hourly MW limits (Markets Gateway>Generator>Unit>Hourly), (2) Daily Unit Schedule Limits (Markets Gateway>Generator> Schedules>Detail), and (3) Unit limits (Markets Gateway>Unit>Detail). Daily unit schedule MW limits can be overridden by unit hourly MW limits. Weather curves for CTs apply to both unit limits and schedule limits.
- Certain Operating Limit parameters are subject to limitations as defined in Section 2.3.4 of this Manual.
- ESR model participants use economic/emergency minimum/maximum charge and discharge limits to represent their operating range to PJM. In the context of the ESR participant model, any references to economic and emergency limits can be translated to generator limits, under the three (3) different operating modes, as follows:

	Charge Mode	Discharge Mode	Continuous Mode
Emergency Maximum	Emergency Minimum Charge	Emergency Maximum Discharge	Emergency Maximum Discharge
Economic Maximum	Charge Minimum	Discharge Maximum	Discharge Maximum
Economic Minimum	Charge Maximum	Discharge Minimum	Charge Maximum

Emergency Minimum	Emergency Maximum Charge	Emergency Minimum Discharge	Emergency Maximum Charge
-------------------	--------------------------	-----------------------------	--------------------------

- A unit bid includes a ramp rate, which is the MW/Minute increase or decrease of a unit being offered for economic dispatch. The ramp rate shall be based on the actual capability of the unit given the confines of the PJM software and shall not be used to withhold a portion of the capacity or ramping capability of a unit from the market. Hourly ramp rates must be updated regularly to account for latest ambient conditions.
- Hourly differentiated segmented ramp rates allow Generation Resources to reflect their ramping capability with greater granularity compared to a single ramp rate or daily segmented ramp rates. Generation Resources with discontinuities in their operating rate (e.g. duct burners, peak firing) should use hourly differentiated segmented ramp rates to reflect such operating modes.
- A unit bid includes an Economic Maximum point, which is the highest output on its bid curve that the unit is offering for economic dispatch. The Economic Maximum represents the highest unrestricted level of MW that the operating company will operate the unit, under its offer, for economic dispatch. The Economic Maximum point shall be based on the actual capability of the unit to operate on its bid curve and shall not be used to withhold a portion of the capacity of a unit from the Day-ahead Market.
- Reduction of the Economic Maximum Megawatt constitutes withholding in the Day-ahead Energy Market, if:
 - The Economic Maximum Megawatt is higher in the bid for the Real-time Energy Market than in the bid for the Day-ahead Market, or;
 - There is no physical reason to designate a lower Economic Maximum for the Day-ahead Market bid than in the bid for the Real-time Market.
- The consequence of withholding a unit's capacity by reduction of the Economic Maximum Megawatt is:
 - The unit will be given an outage ticket which reflects a derating equal to the positive difference in the Economic Maximum output designated in the bid for the Real-time Market and in the bid for the Day-ahead Market.
- CT's are permitted to provide an Economic Minimum less than the physical economic minimum value of the unit.
- When a unit or part of a unit is designated as Maximum Emergency (ME), this means that the referenced output levels may require extraordinary procedures and that the designated MW is available to PJM only when PJM requests Maximum Emergency Generation. Designation of a unit or a portion of a unit as ME should be based on the real operating characteristics of the unit and not be used to withhold all or a portion of the capacity of a unit from the Day-ahead Market.
- Designation of all or part of a unit's capacity as ME constitutes withholding in the Day-ahead Market, if:
 - The capacity is not designated as ME in the bid for the Real-time Market, or;

- There is no physical reason to designate the unit as ME.
- The consequence of withholding a unit's capacity under ME is:
 - The unit will be given an outage ticket which reflects a de-rating equal to the positive difference in capacity designated Maximum Emergency in the bid for the Day-ahead Market and capacity designated Maximum Emergency in the bid for the Real-time Market.

Generation Offer Business Rules

- Generation offers may consist of startup, no-load and incremental energy offer.
- Market Sellers can select the 'Switch to Cost Schedule' flag in Markets Gateway (Detail Updates tab) beginning on the day prior to the Operating Day until 11:00 and again starting at 18:30 through sixty-five (65) minutes prior to the operating hour. Selecting this flag will make the price-based schedule(s) unavailable for the remainder of the Operating Day selected and will ensure any future commitments for the Operating Day are made on an available cost-based schedule. Once the Switch to Cost Schedule option is selected, the Market Seller will not have the option to resume using the price-based schedule for the remainder of the Operating Day.
- Any hourly updates made to the Offer Updates or Detail Updates pages of Markets Gateway supersede the daily values on the Offer and/or Detail pages. Hourly updates made on the Offer Updates or Detail Updates pages are not carried over into the next Operating Day.
 - Refer to Section 2.3.4.6 of this Manual regarding updating the Minimum Run Time parameter in Markets Gateway for a combined cycle pseudo model block(s) when one or more pseudo modeled combined cycle blocks are not dispatched in Real-time.

Startup and No-load Business Rules:

- A price-based unit has the option to choose to submit cost-based startup and no-load fees. A price-based unit that chooses the cost-based option may specify the startup and no-load fees for each hour and update those values in Real-time in accordance with the rules defined in Section 9.1 of this Manual. A priced-based unit that chooses the price based option is able to change the startup and no-load fees twice a year.
- The choice between using cost-based and price-based startup and no-load fees can be made twice a year during the open enrollment window (on or before 11:00 hours March 31 for the period April 1 through September 30 and on or before 11:00 hours September 30 for the period October 1 through March 31). Period 1 is defined as the period of time beginning April 1 and ending September 30. Period 2 is defined as the period of time beginning October 1 and ending March 31. If a priced based unit chooses the cost-based startup and no-load fees option, the decision cannot be changed until the next open enrollment period takes place.
 - Hybrid Resources or resources enrolled in the ESR participation model cannot have startup and no load costs entered.

Incremental Energy Offer Business Rules:

- Generation resource cost-based incremental energy offers may exceed \$1,000/MWh, but may not exceed \$2,000/MWh for the purpose of dispatch and calculating LMP.
- Cost-based incremental energy offers greater than \$1,000/MWh, and less than \$2,000/MWh, must be verified prior to being used in dispatch and the calculation of LMP as described in Section 2.3.6.2 of this Manual.
- Any cost-based offers greater than \$1,000/MWh, which were not verified in time to set LMP, or any cost-based offers greater than \$2,000/MWh may be eligible to receive credit for Operating Reserves. Market Sellers must submit all relevant documentation demonstrating the calculation of costs greater than \$1,000/MWh to PJM and the MMU in accordance with Attachment D of this Manual.
- Generation resource market-based incremental energy offers may not exceed \$1,000/MWh unless the cost-based incremental energy offer is greater than \$1,000/MWh. If this is true, then the market-based incremental energy offer is capped at the lesser of the cost-based incremental energy offer or \$2,000/MWh. In instances where the price-based incremental energy offer exceeds \$1,000/MWh:
 - A reference cost-based schedule with which to compare the price-based schedule must be specified. The reference cost-based schedule should have the same fuel type as the price-based schedule.
 - The price-based schedule and the reference cost-based schedule must have the same offer slope selection and identical MW break points on their incremental energy offers in order to facilitate validation of the price-based offer.
 - The incremental energy offer price for each segment on the price-based schedule must be less than or equal to the incremental energy offer price of the corresponding segment on the reference cost-based offer.
 - The startup and no-load fees on the price-based offer must be less than or equal to those on the reference cost-based offer.
 - Any price-based incremental energy offers submitted above \$1,000/MWh will be capped at \$1,000/MWh if the above requirements are not met.
 - If, after validation, subsequent changes are made to the reference cost-based schedule that result in the price-based offer being out of compliance, any segments of the price-based incremental energy offer above \$1,000/MWh will be capped at \$1,000/MWh.
 - The maximum number of MW/Price segments that can be submitted per hour is twenty (20).

2.3.3.3 Aggregated Unit Business Rules

- Generating units that are connected to the system at the same electrical location may be aggregated and offered into the PJM market as a single unit.

- The aggregated unit must be offered into the PJM markets as a single unit with only one set of offer data, including startup, no load and incremental energy costs. This rule applies to all energy and ancillary service markets into which the unit is offered.
- Revenue quality meter data must be submitted to Power Meter on the basis of the aggregated unit.
- Real-time meter data is required for each physical unit in order to support the PJM state estimator model and to allow energy settlement on an individual unit level.
- Balancing Operating Reserve deviations for aggregated units are calculated based on the five (5) minute aggregated unit output as defined in PJM Manual 28: Operating Agreement Accounting.
- Balancing Operating Reserve Generator deviations for units deemed to be “not following dispatch” that occur at a single bus will be able to offset one another.
- A “single bus” will be any unit located at the same site and that has the identical electrical impacts on the transmission system. Units are deemed to have identical electrical impacts on the transmission system if they meet the following criteria:
 - Units that have identical distribution factors to the system.
 - Units that are on the same low side of the bus (i.e. connected at same voltage level).
- In the case of units on buses with a bus-tie breaker, if the bus-tie breaker was open less than 5% of the hours in the previous three (3) years, supplier netting of units will be allowed across this bus-tie breaker.
- PJM will maintain a list of units that are deemed to have identical electrical impacts on the transmission system to be used for Balancing Operating Settlement. PJM will review the list on an annual basis. Generators will be reviewed as needed during any new generation activation or reconfiguration process as defined in Section 7 of PJM Manual 14D: Generator Operational Requirements.
- Unit parameters do not have to be identical for the units’ deviation MW to offset one another.
- If multiple units are deemed “not following dispatch” at a single bus, the deviation MW and direction of each unit at that bus will be summed to determine the deviation MW at that bus.
- Units at a “single bus” must be owned or marketed by a single PJM Market Participant.
- Unit modeling changes in the PJM Markets Gateway system (unit type, aggregation level, for example), not including changes based on physical changes at the plant, can be made at the beginning of each quarter.
- Per the PJM Manual for Operating Agreement Accounting (M28), for settlement purposes, PJM determines the resource’s five (5) minute RT SCED LMP Desired MWh based on its dispatch rate, offer data, and minimum and maximum energy limits for that five (5) minute interval. For steam units, the lesser of the Day-ahead scheduled and Real-time economic minimum limits, and the greater of the Day-ahead scheduled and Real-time economic

maximum limits, are used. For CT's, operating at PJM direction, the actual Real-time output is used as the RT SCED LMP Desired MWh value.

2.3.3A External Market Sellers

An External Resource is a generation resource that is located outside the metered boundaries of PJM. External resources that are committed Capacity Resources must bid into the PJM Day-ahead Market as generation resources.

For an External Resource to be offered into the Day-ahead Market a valid generator offer, as detailed in Section 2.3.3 of this Manual, is submitted in the Markets Gateway system and a valid energy schedule is submitted in the ExSchedule system.

External Market sellers report the following data for resource-specific offers, reported on the business day before the next Operating Day, up to seven (7) days in advance:

- Specific generation resource. If the resource is submitted at least thirty (30) days before the bid date, see PJM Manual 10: Pre-Scheduling Operations.
- Minimum and maximum energy for each hour.
- Minimum and maximum generation for each hour.
- Minimum and maximum run times.
- Resource availability for each hour.
- Availability of regulation upper and lower energy limits for each hour.
- Response and constraint data.
- Whether or not to use startup and no-load fees.

The Network Customer may request Network External Designated transmission service for the delivery of a designated network resource. Requests for service are subject to Available Transmission Capability (ATC) and other PJM [Regional Practices](#).

A valid NERC eTag is required for all hours that the external resource will be bid into PJM. The firm OASIS reservation assigned to the external resource shall be linked to the tag.

2.3.3A.1 External Resource Day-ahead Market Requirements

As specified in Section 2.3.1 of this Manual, all bids must be received by 11:00 (EPT). From 11:00 to 13:30 (EPT), the bids are evaluated. Results are posted in the Markets Gateway system by 13:30 (EPT). External Market Sellers are required to check the Markets Gateway system to see if the bid has been accepted.

For bids accepted in the Day-ahead Market, External Market Sellers must submit adjustments to the hourly profile of their tag in order to avoid balancing market MW deviations.

2.3.3A.2 External Resource Reliability Assessment and Commitment Run Requirements

If the unit is accepted in the Reliability Assessment and Commitment (RAC) Run, External Market Sellers must submit a NERC eTag that matches the hourly energy profile.

If the bid is not accepted in the Day-ahead Market the External Market Seller may choose to either modify an already existing tag to zero (0) MW, or take no action.

If the External Market Seller wishes to schedule the resource as a self-scheduled/must run resource they may choose to do so and must submit an eTag. The External Market Seller must also notify the PJM Generation Dispatcher that the resource is being self-scheduled into PJM as a contract.

2.3.3A.3 External Resource Real-time Market Requirements

If the bid is not accepted in the Day-ahead Market or Real-time Market, but is requested during the Operating Day, the PJM Generation Dispatcher will notify the External Market Seller who will then submit an eTag to match the request. This tag is subject to all scheduling timing requirements and PJM interchange ramp limits.

2.3.3.4 Public Distribution Microgrid Generators

All existing Energy & Ancillary Services Market Business Rules apply to a Public Distribution Microgrid (PDM) Generator operating in grid-connected mode. Additional business rules apply to a Public Distribution Microgrid Generator operating in island mode:

- If the Public Distribution Microgrid load is reported to PJM as wholesale load when the PDM is islanded, the corresponding Public Distribution Microgrid Generator(s) should update their availability in Markets Gateway to Must Run for corresponding intervals in order to reflect the islanded condition.
- If the Public Distribution Microgrid load is not reported to PJM as wholesale load when the PDM is islanded, the corresponding Public Distribution Microgrid Generator(s) should make themselves unavailable for all PJM markets for the corresponding intervals to reflect the islanded condition.
- When the PDM is in island mode, an operator of a Public Distribution Microgrid Generator shall de-assign it from any existing Ancillary Services commitments (performance will be assessed as normal), and shall ensure it is not assigned for ancillary services for future intervals unless it is certain it will not be islanded in those intervals.

Definitions and additional business rules for Public Distribution Microgrids can be found in PJM Manual 14D, Appendix B: Public Distribution Microgrid Business Rules and PJM Manual 14D, Appendix C: Voluntary Guideline on Public Distribution Microgrid Operations.

2.3.4 Minimum Generator Operating Parameters – Parameter Limited Schedules

Market Sellers of Capacity Resources are required to submit, per Section 2.3.3.2 of this Manual, as follows:

- For Price Based Units: (1) at least one cost-based schedule that is parameter limited, (2) a price-based Parameter Limited Schedule.
- For Cost Based Units: (1) at least one cost-based schedule that is parameter limited.

Certain parameters on cost-based and price-based PLS schedules are subject to defined limits. The following subsections provide details regarding which parameters are limited, the process to request exceptions to the limits, and the circumstances when such Parameter Limited Schedules are considered during commitment and dispatch.

2.3.4.1 Parameter Limits

Different limits may be applied to certain schedule parameters depending on a resource's Capacity commitment type and the applicable Delivery Year.

- All Capacity Resources are subject to unit specific operating limits for the following parameters:
 - Turn Down Ratio
 - Minimum Down Time
 - Minimum Run Time
 - Maximum Daily Starts
 - Maximum Weekly Starts
 - Maximum Run Time
 - Start-Up Time
 - Notification Time
- PJM determines unit-specific parameter limits for each Capacity Resource based on the operating design characteristics and other constraints of that resource. The resource's unit-specific parameter limits will apply for that resource unless it is operating pursuant to an exception from those limits as described in Section 2.3.4.2 of this Manual.

2.3.4.2 Unit Specific Parameter Adjustments

- Market Sellers that do not believe their individual resources can meet the unit-specific parameter limits determined by PJM due to actual operating constraints, can request that PJM establish adjusted unit-specific parameter limits for those resources. The Market Seller may request adjusted unit-specific parameter limits by providing all the necessary data, information and documentation to PJM in order to justify and support the adjusted limits through the Unit Specific Parameter Adjustment Process PJM [SharePoint](#) website by no later than the February 28 immediately preceding the first Delivery Year for which the adjusted unit-specific parameter limits are requested to commence. Technical information

must be provided about the operational limits that support the requested adjustment. PJM shall notify the Market Seller if its request was approved or denied by no later than April 15. The effective date of approved adjustments shall be no earlier than June 1 of the first applicable Delivery Year. PJM will consult with the MMU and consider any input received in its determination of a resource's unit-specific parameter limits.

- Once PJM has made a determination of the unit-specific parameter limited schedule values for a Generation Capacity Resource, those values will remain applicable to the resource until such time as PJM determines that a change is needed based on changed operational capabilities of the resource.
- The operational limitations that support adjusted unit-specific parameter limits shall be (a) a physical operational limitation based on operating design characteristics of the resource or (b) other actual physical constraints that are not based on the characteristics of the resource, including contractual limitations. Economic constraints are not taken into consideration in the determination of the unit-specific parameter limits. Contractual limits may only be considered a physical constraint and not an economic constraint when based on a natural gas pipeline transportation contract that is for the best available service offered by the pipeline and available to the Market Seller rather than a lower cost option that provides less flexible service. For example, if a pipeline offers hourly nominations and/or no notice service, the resource's operational parameters will be based on those more flexible services that are available even if a less flexible service is procured.
- Only actual physical operational limitations, fuel contractual constraints, environmental limitations and other actual constraints on a resource will be considered for adjustment requests. The following list is not an exhaustive list, but provides examples of the types of information and documentation PJM would request to support adjusted unit-specific parameter limits requests:
 - Start-Up Time Adjustments – Original Equipment Manufacturer (OEM) backup documentation, control room data, start-up/loading curves and a detailed start-up sequence listing the required steps along with the time required to perform each step.
 - Maximum Daily/Weekly Starts Adjustments – OEM backup documentation and/or detailed start-up and shutdown sequences that show why the default start parameters cannot be physically met.
 - Minimum Run Time Adjustments – OEM backup documentation for physical resource constraints that requires the unit to be operated for the requested time period.
 - Minimum Down Time Adjustments - OEM backup documentation and a detailed shut down sequence listing the required steps to bring the resource into a ready for start-up condition along with the time required to perform each step.
 - Notification Time Adjustments – A detailed sequence of events of the tasks required prior to start-up along with the time required to perform each step. In addition gas pipeline contracts may be submitted for review.
 - Turn Down Ratio Adjustments – OEM backup documentation describing the equipment limitation. Requests for adjustments to this parameter based on emissions

permit limitations and related concerns will require inclusion of the applicable Air Permit as well as emissions data for justification.

2.3.4.3 Parameter Limited Schedule Exceptions

- There are three (3) different types of exceptions to the Parameter Limited Schedule Matrix default values:
 - Temporary Exception – A one-time exception lasting for thirty (30) days or less during the twelve month period from June 1 to May 31.
 - Period Exception – Lasting for at least thirty-one (31) days but no more than one year during the twelve month period from June 1 to May 31.
 - Persistent Exception – Lasting for at least one year.
- Pursuant to Section II.B of Attachment M – Appendix of the Tariff, Period and Persistent Exception requests must be sent to Parameters.Exceptions@pjm.com by no later than February 28 immediately preceding the twelve month period from June 1 to May 31 during which the exception is requested to commence.
- All Market Sellers that wish to submit a Parameter-Limited Schedule for resources with physical operational limitations that prevent the resources from meeting the minimum parameters may submit a request for an exception via Markets Gateway for evaluation.
- Each Market Seller seeking an exception must supply the required historical resource operating data in support of the Period or Persistent Exception and if the exception requested is based on new physical operational limits for the resource for which historical operating data is unavailable, the generation resource may also submit technical information about the physical operational limits for Period Exceptions of the resource to support the requested parameters.
- Physical operational limitations for Period or Persistent Exceptions may include but are not limited to, metallurgical restrictions due to age and long term degradation; physical design modifications, operating permit limitations, operating limits imposed by federal, state or local regulatory requirements or insurance carrier requirements, consent decrees, manufacturer technical bulletins, or environmental permit limitations under non-emergency conditions.
- Each Market Seller requesting a Period or Persistent Exception based on new physical operational limitations for a resource may submit the technical information, required due to the unavailability of historical operating data, supporting the requested parameters, which must be based on the definition of physical operational limitations for Period or Persistent Exceptions of the resource.
- Each Temporary, Period or Persistent Exception request will indicate the expected duration of the requested exception including the date on which the requested exception period will end. If physical conditions at the unit change such that the exception is no longer required, the Market Seller is obligated to inform PJM and the MMU and the exception will be reviewed to determine if the exception continues to be appropriate.

- If a request for a period or Persistent Exception is received by February 28, the MMU will review the exception and provide the Market Seller and PJM with a determination in writing whether the request raises market power concerns by April 1, and PJM shall provide its determination whether the request is approved or denied by no later than April 15. Should PJM require additional technical expertise in order to evaluate the exception request, PJM will engage the services of a consultant with the required expertise. A generation resource shall notify the MMU and PJM when the temporary exception commences and terminates and provide to the MMU and PJM within three (3) days following such commencement documentation explaining in detail the reasons for the Temporary Exception, that includes:
 - Unit Name.
 - Parameter Limit Requested.
 - Reason for Temporary Exception Request.
 - eDart ticket.
 - Justification for Temporary Exception Request, including required resource operating data in support of the exception.
 - Date on which the exception period will end.
- If PJM does not receive a complete exception request, and the resource did not clear in the Day-ahead Energy Market, the resource schedule will be returned to its previous parameter limits.
- Physical operational limitations for Temporary Exceptions may include, but are not limited to, short term equipment failures, short term fuel quality problems such as excessive moisture in coal fired units, or environmental permit limitations under non-emergency conditions.
- Market Sellers may use exceptions to reflect physical operational limitations (e.g., operational flow orders) on natural gas pipelines and local natural gas distribution companies (LDC). These exceptions will be reviewed by PJM and the MMU and approved by PJM, in accordance with the applicable provisions of the Tariff and Operating Agreement.
- A temporary exception may only be requested one-time for the same physical and actual constraint per occurrence since an operational constraint that may periodically exist more than once should be the subject of a period exception request rather than multiple temporary exception requests.
- The Market Seller shall notify the Office of the Interconnection and the MMU in writing of any updates to the physical condition of the unit and shall notify the Office of Interconnection and the MMU in writing of an early termination of a temporary exception due to changed physical conditions by no later than on Business Day prior to the early termination date.
- A Market Seller shall provide supporting documentation demonstrating the actual termination date of the physical and actual parameter limitation that prompted the need for

the temporary exception to the Office of Interconnection and the MMU within one Business Day of the termination of such condition.

- In addition, physical operational limitations for Temporary Exceptions may include any physical operational limitation for period exceptions that arises during the annual period from June 1 to May 31 to which period exceptions apply.
- Market sellers may indicate to PJM and the MMU those resources with the ability to operate on multiple fuels. Multiple-fuel resources may submit a Parameter Limited Schedule associated with each fuel type. All Parameter Limited Schedules must be submitted via Markets Gateway seven (7) days prior to the beginning of each period beginning June 1. Any exceptions required for any of the Parameter Limited Schedules submitted for multiple-fuel resources will be required to be submitted and approved via the exception process, by the applicable deadlines.
- Market Sellers shall notify, in writing, the MMU and PJM of a material change to the facts relied upon by the MMU and/or PJM to support a Temporary, Period or Persistent Exception. The MMU will provide written notice of any change to its determination regarding the exception request within fifteen (15) days of receipt of such notice to PJM and the Market Seller. PJM will notify the Market Seller and MMU in writing, by no later than twenty (20) days after receipt of the Market Seller's notice, whether it is revoking or confirming its approval of the exception request.
 - If PJM determines that its approval of the exception should be revoked or terminated for Capacity Resources without approved adjusted unit-specific values, the unit-specific values determined by PJM shall apply and for Capacity Resources with approved adjusted unit-specific values, the adjusted unit-specific values shall apply. PJM shall notify the Market Seller three (3) business days before such revocation.

2.3.4.4 Retired

2.3.4.5 Consideration of Price-based Parameter-Limited Schedules in Commitment and Dispatch

Generation Capacity Resources shall be eligible for commitment on Parameter-Limited Schedules:

- In the event that PJM: (i) declares a Maximum Generation Emergency; (ii) issues a Maximum Generation Emergency Alert, Hot Weather Alert, Cold Weather Alert; or (iii) schedules resources based on the anticipation of a Maximum Generation Emergency, Maximum Generation Emergency Alert, Hot Weather Alert or Cold Weather Alert for all or any part of such Operating Day; generation resources will be committed on the more economic schedule of their price based Parameter Limited Schedule and price based schedule.
- Under the above circumstance, if a Market Seller fails the Three Pivotal Supplier test in the Energy Markets, the Seller's resources will be committed on the schedule with the least

cost among the cost-based schedule, price-based schedule and price-based Parameter Limited Schedule.

2.3.4.6 Minimum Run Time for Pseudo Modeled Combined Cycle Units

The approved combined cycle Minimum Run Time unit specific parameter includes the time necessary for start-up of the unit's steam turbine. Submitted cost-based and price-based PLS offers must be at least as flexible as the approved parameter limits for the resource, and if one or more of a pseudo modeled combined cycle block(s) is not dispatched in the Real-time with associated pseudo model block(s), Market Sellers must update the Minimum Run Time parameter of the second and any subsequent pseudo modeled blocks in Markets Gateway to remove the associated steam turbine start-up time that is included in the parameter limit. Such update must occur if and when the subsequent units are dispatched, if not before.

2.3.4A Internal and External Bilateral Transactions

The following business rules apply to Transmission Customers:

- Transmission customers may submit external bilateral transaction schedules and may indicate willingness to pay congestion charges into either the Day-ahead Market or Real-time Market. In the Day-ahead Market, a transaction shall indicate willingness to pay congestion charges by submitting the transaction as an 'Up-To' congestion bid. Refer to Section 2.3.2.3 of this Manual for business rules pertaining to Up-To Congestion transactions.
- Internal bilateral transactions may be designated as Day-ahead or Real-time Market in PJM InSchedule.

The following business rules apply to any generator within the PJM metered boundary and are pseudo-tied into the MISO Balancing Authority:

- The Day-ahead Pseudo-Tie Transaction may only be submitted by Market Participants whose generator is within the PJM metered boundary and are pseudo-tied into the MISO Balancing Authority.
- The eligible source of the Day-ahead Pseudo-Tie Transaction is the generator location and the eligible sink is the MISO interface.
- The Market Participant may submit the Day-ahead Pseudo-Tie Transaction at each eligible location up to the transmission service reservation associated with the Pseudo-Tie.
- Day-ahead Pseudo-Tie Transaction bids shall be no greater than \$50/MWh and no less than -\$50/MWh. Any Day-ahead Pseudo-Tie Transaction that bids higher than \$50/MWh or less than -\$50/MWh will be rejected.
- Day-ahead Pseudo-Tie Transaction bids shall be supported in the Day-ahead Market only.
- Day-ahead Pseudo-Tie Transaction bids are cleared based on the total LMP price difference between the source and the sink.

2.3.4B Energy Storage Resource (ESR) Participation Model

An Energy Storage Resource (ESR) is a resource capable of receiving electric energy from the grid and storing it for later injection to the grid that participates in the PJM Energy, Capacity and/or Ancillary Services Markets as a Market Participant.

The Energy Storage Resource participation model is an optional model for ESRs to schedule their operation into PJM Markets. Energy Storage Resources participating in the model make their own commitment decisions in Energy and can be dispatchable within their specified operating limits. Energy Storage Resources that elect to be in the ESR participation model cannot also elect to be optimized by PJM in the pumped storage hydro optimizer.

ESR Participation Model Election (i.e. Opt In/Opt Out)

- Resources must opt into the Energy Storage Resource Participation Model by sending a request to Member Relations at custsvc@pjm.com.
- Once a resource opts in for ESR participation, the opt-in status remains until an opt-out request is received.
- Existing resources must send opt-in requests no later than September 30 for the upcoming January 1 to December 31 participation months.
- Resources within the new resource queue process must send an opt in request no later than three (3) months in advance of their initial start in the Energy Markets.
- An opt out request for an existing resource must be sent to Member Relations at custsvc@pjm.com no later than September 30 to remove the resource for the upcoming January 1 to December 31 participation months.

ESR Mode Designation

ESR model participants are not optimized for commitment decisions in Day-ahead and Real-time because they are managed directly by participants through specification of the four modes of operation:

- Continuous mode – shall mean the mode of operation of an Energy Storage Resource model participant that includes both negative and positive MW quantities (i.e., the Energy Storage Resource model participant is capable of continually and immediately transitioning from withdrawing MW quantities from the grid to injecting MW quantities onto the grid). ESR model participants operating in Continuous Mode cannot specify a ramp rate as it is assumed to be unlimited. Continuous mode requires the Maximum Discharge Limit to be greater than or equal to zero and the Maximum Charge Limit to be less than or equal to zero.

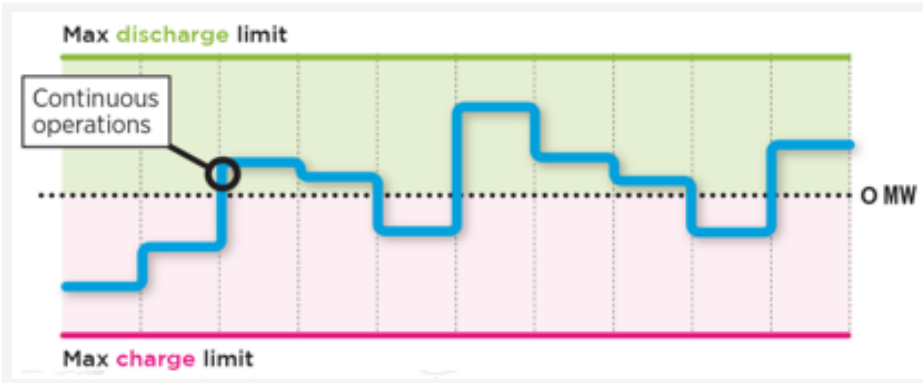

- Charge mode - shall mean the mode of operation of an Energy Storage Resource model participant that only includes negative MW quantities (i.e., the Energy Storage Resource model participant is only withdrawing MWs from the grid). Charge Mode requires that the Energy Storage Resource model participant's Minimum Charge Limit and the Maximum Charge Limit be less than or equal to zero, and the Energy Storage Resource model participant is required to define a ramp rate.

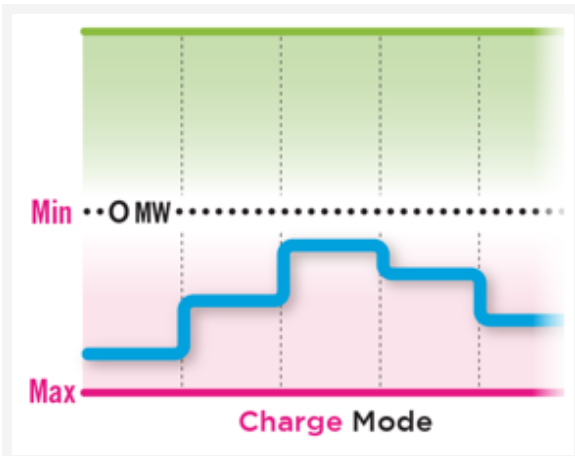

- Discharge mode - shall mean the mode of operation of an Energy Storage Resource model participant that only includes positive MW quantities (i.e., the Energy Storage Resource model participant is only injecting MWs onto the grid). Discharge Mode requires the Minimum Discharge Limit and the Maximum Discharge Limit to be greater than or equal to zero. A ramp rate is required in this operating mode.

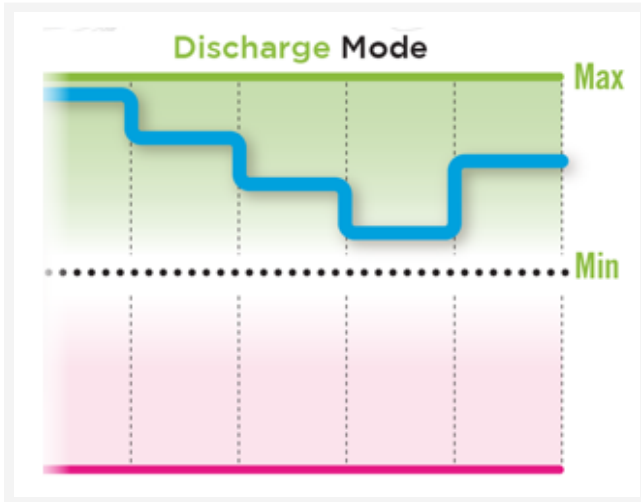

- Unavailable - Indicates that the resource is not available for Energy.

These modes are to be used by both the Day-ahead and Real-time Markets. These modes are to be submitted by the Market Participant on an hourly basis through Markets Gateway by 11:00 the day before the Operating Day for Day-ahead and sixty-five (65) minutes before the operating hour for Real-time.

2.3.4C Mixed Technology Facility

This section describes how a Mixed Technology Facility can provide energy and ancillary services in the PJM marketplace.

Mixed Technology Facility is a facility that features multiple and distinct generation technology types behind the same point of interconnection. Individual technology types are referred to as components. There are alternate ways that the components of a Mixed Technology Facility can participate in PJM Markets, as either (1) Co-Located Resources, where the components are modeled and dispatched as two or more separate resources; or (2) integrated Hybrid Resource, where components are modeled and dispatched as a single integrated resource. However, a Mixed Technology Facility which features significant interactions between the generation and/or storage components are required to participate in markets as a single Hybrid Resource.

Co-Located Resources participate in the Capacity, Energy and/or Ancillary Services market(s) individually as separate resources and follow the relevant business rules for each modeled resource accordingly. Hybrid Resources participate in accordance with Section 2.3.4C.1 below.

Mixed Technology Facility that is eligible to participate in capacity and energy markets as either a Hybrid Resource or as multiple Co-Located Resources, the modeling classification chosen for the energy market and capacity market participation must match for the applicable Delivery Year.

For a Mixed Technology Facility that has no components that participate in the Capacity market, and that is eligible to participate in the energy markets as either a Hybrid Resource or as multiple Co-Located Resources, the modeling classification can be changed once per calendar year with notice to PJM by no later than May 30 for the upcoming January 1 to December 31 participation months. An annual modeling classification change provides adequate flexibility to accommodate the business interests of the owners of such resources, while providing a stable basis from which to administer market outcomes. Once a modeling status is chosen, it remains until another request is received. For an energy-only Mixed Technology Facility within the new resource queue process, the modeling choice must be made no later than six (6) months in advance of its initial start in the Energy markets. Six months provides sufficient time for the modeling choice to be reflected in PJM’s EMS, markets system, and settlement systems.

2.3.4C.1 Hybrid Resource

A Hybrid Resource is an Energy Resource or a Generation Capacity Resource composed of more than one component behind the same Point of Interconnection operating in the Capacity, Energy, and/or Ancillary Service market(s) as a single integrated resource, whereby each component is a separate generation and/or storage technology type. A Hybrid Resource forms all or part of a Mixed Technology Facility. A Closed-Loop Hybrid Resource is a Hybrid Resource without a storage component, or that is physically or contractually incapable of charging from the grid. An Open-Loop Hybrid Resource is a Hybrid Resource with a storage component that is physically or contractually capable of charging its storage component from the grid. For a Hybrid Resource that has no components that participate in the Capacity market, and that is eligible to participate in the energy markets as either a Closed-Loop or Open-Loop Hybrid Resource, the modeling classification timeline is the same as a Mixed Technology Facility.

A Hybrid Resource consisting solely of inverter-based components with at least one storage component is eligible to participate in Energy and Ancillary Services markets using a similar approach as the Energy Storage Resource participation model described immediately above section 2.3.4B. A Hybrid Resource consisting solely of non-storage inverter-based components is eligible to participate in Energy and Ancillary Services markets using a similar energy market participation model as used by wind resources. The operational modes are used as shown below in table 1. A Hybrid Resource does not have “ancillary-only mode” and “regulation only mode”. Closed-Loop Hybrid Resources that lack the Charge Maximum and Minimum parameters cannot submit offers for negative megawatts and do not have charge mode. Open-Loop Hybrid Resources must indicate to PJM the intervals in which the battery is idle (i.e., its output capability is solely a function of available non- storage energy) as Intermittent Mode.

Table 1. Hybrid Resource Operation Modes

Mode	Hybrid Resource Type	
	Open-Loop Hybrid Resource	Closed-Loop Hybrid Resource
Continuous	Yes	N/A

Discharge	Yes	Yes
Charge	Yes	N/A
Intermittent	Same as Discharge	Same as Discharge

2.3.5 Curtailment Service Providers

The business rules that apply to Curtailment Service Providers are set forth in Section 10.2.2 of this Manual.

2.3.6 PJM Activities

The following business rules apply to PJM activities:

- PJM shall post on the Markets Gateway System, the PJM load forecast, total bid demand, and Day-ahead Reserve objective for each hour of the next Operating Day by 13:30 at the completion of the Day-ahead scheduling process.
- PJM shall post forecasts of total hourly demand for the next four (4) days and peak demand for the subsequent three (3) days.
- PJM shall post hourly LMP, Congestion Price, and Loss Price values for the next Operating Day at the completion of the Day-ahead scheduling process by 13:30.
- PJM shall post the schedule of demand, supply, and bilateral transactions for private viewing by Market Participants.
- PJM may perform supplemental resource commitments after the Day-ahead schedule is posted in order to maintain reliable operation. Such supplemental commitments are based on minimizing startup and no-load costs.
- During the various resource commitment analyses, PJM may limit its dependence on Combustion Turbines (CTs) to provide reserves in order to maintain reliable operational standards. Such limits shall be based on past performance of these resources.
- PJM Market Operators will commit in the Day-ahead Market any generation resources that were scheduled by PJM dispatch in advance of the Day-ahead Market and are still required for the Operating Day and therefore not cancelled. The scheduled hours for the pre-committed generation resource in the Day-ahead Market will at least include the hours where PJM dispatch has scheduled the resource as well as any additional hours where the resource was deemed to be economic as a result of the Day-ahead Energy Market solution.

2.3.6.1 Market Power Mitigation

PJM tests for the concentration of local market power under transmission constrained conditions and applies measures to mitigate such power when detected. If transmission limits are identified during the Day-ahead scheduling process or during Real-time operations, the appropriate generators (those for which the owner fails the Three-Pivotal Supplier Test (“TPS Test”) as detailed in Section 6.4.1 paragraphs (e) and (f) of the PJM Operating Agreement) are offer-

capped. Resources remain eligible to set LMP when offer-capped. Both pool-scheduled and self-scheduled resources are eligible for offer capping. The Three-Pivotal Supplier Test is performed in IT SCED, further described in in Section 2.5 of this Manual, as part of the dispatch run. Offer capping, as described below, is based on the results of the Three Pivotal Supplier Test.

Offer-capping is applied as follows:

- Resources are offer-capped at lesser of their cost-based or price-based schedules, including startup and no-load components. Specific details regarding determination of cost-based offers may be found in PJM Manual 15: Cost Development Guidelines and Section 6.4.2 of the PJM Operating Agreement.
- For resources scheduled in the Day-ahead Market, the offer caps are applied at the time of commitment and apply for the length of time the unit is scheduled in the Day-ahead Market at the schedule that results in the lowest overall system production cost, in accordance with Section 6.4.1(a) of the Operating Agreement.
 - If the incremental energy offer, no load cost or startup cost for any portion of the offer capped hours is updated subsequent to the Day-ahead commitment, the offer caps are recalculated for each hour that was updated and apply at the schedule that results in the lowest dispatch cost for each updated hour, in accordance with Section 6.4.1(g) of the Operating Agreement; however, once the resource is dispatched on a cost-based offer, it remains on a cost-based offer regardless of the determination of the cheapest schedule.
- For resources scheduled in the Real-time Market, the offer caps are applied at the time of commitment and apply at the schedule which results in the lowest dispatch cost, in accordance with Section 6.4.1(g) of the Operating Agreement.
 - If the incremental energy offer, no load cost or startup cost for any portion of the offer capped hours are updated subsequent to the Real-time commitment, the offer caps will be recalculated for each hour that is updated and will apply at the schedule that results in the lowest dispatch cost for each updated hour in accordance with Section 6.4.1(g) of the Operating Agreement; however, once the resource is dispatched on a cost-based offer, it will remain on a cost-based offer regardless of the determination of the cheapest schedule.
- Non-CT resources, as well as CTs that are committed in the Day-ahead Market and are expected to run in the Real-time Market without additional notification from PJM Dispatch, that are offer-capped in the Day-ahead Market are offer-capped for those same hours in the Real-time Market and at the same schedule.
- Pool-scheduled CTs that are committed in the Day-ahead Market and are not expected to run in Real-time unless notified by PJM Dispatch and are offer-capped in the Day-ahead Market and are re-evaluated for market power at the time of commitment in the Real-time Market. Such resources are offer-capped in accordance with the results of the TPS Test that is conducted at the time of the Real-time commitment.

- Pool-scheduled resources brought on-line for economics prior to constrained conditions are not offer-capped at the time of commitment.
- Resources whose owners passed the TPS Test at the time of commitment remain uncapped and are not be subject to additional market power testing until the end of the initial capping determination period, which is defined as follows:
 - For pool-scheduled or self-scheduled resources committed in the Day-ahead Market, the end of their Day-ahead commitment.
 - For pool-scheduled resources committed in the Real-time Market (and not in the Day-ahead Market): the end of their minimum run time.
 - For self-scheduled units committed in the Real-time Market (and not in the Day-ahead Market): the end of the first hour of their commitment.
- Resources running in Real-time beyond the initial capping determination period are subject to evaluation for market power on an hourly basis and are offer-capped as follows:
 - Resources operating on a price-based schedule whose owner pass the TPS Test will not be offer-capped and will remain on the price-based offer.
 - Resources operating on a price-based schedule whose owner does not pass the TPS Test will be offer-capped.
 - Resources operating on a cost-based schedule will remain on a cost schedule regardless of the results of the TPS Test.
- Once a unit is offer-capped in the Real-time Market it shall remain offer-capped until the earlier of:
 - The resource's release from its commitment by PJM Dispatch.
 - The end of the Operating Day.
 - The start of the resource's next pre-existing commitment.

2.3.6.2 Resource Energy Offer Validation (for offers greater than \$1,000/MWh)

Generation Resource Offer Screening Process

PJM uses a screening process to verify the reasonableness of each generation resource's cost-based Incremental Energy Offer segment in excess of \$1,000/MWh before it is considered eligible to be used in dispatch or the calculation of LMPs. This screening process is applicable to all generation resources including those that are Fast-Start capable. Fast-Start capable resources are subject to an additional screening process as described in Section 2.3.6.3 of this Manual.

- Cost-based Incremental Energy Offers with prices above \$1,000/MWh are subject to the offer screening process at the time of submission.
- Day-ahead Market Incremental Energy Offers between \$1,000/MWh and \$2,000/MWh must be submitted prior to the close of the Day-ahead Market bid period to be screened for eligibility to set LMP in the Day-ahead Market.

- In Real-time, a resource's cost-based offer must be submitted at least sixty-five (65) minutes prior to the start of the operating hour in order for the Incremental Energy Offer segments between \$1,000/MWh and \$2,000/MWh to be screened for eligibility to set LMP.

PJM uses cost inputs provided by the Market Seller to calculate the Maximum Allowable Incremental Cost as outlined in Section 6.4.3 of Schedule 1 of the PJM Operating Agreement. Submission to MIRA, or other system(s) made available is considered submission to PJM and the MMU.

- The Market Seller shall provide heat inputs and performance factors in MIRA, or other system(s) made available for submission of such data. The heat inputs and performance factors should be provided at least one week prior to the Operating Day.

For each Incremental Energy Offer segment greater than \$1,000/MWh, PJM shall evaluate whether such offer segment exceeds the reasonably expected costs for that generation resource by determining the Maximum Allowable Incremental Cost for each segment in accordance with Section 6.4.3 of Schedule 1 of the PJM Operating Agreement.

- If the cost submitted for the offer segment is less than or equal to the Maximum Allowable Incremental Cost value, then that segment is deemed verified and is eligible to be used in dispatch and to set LMP.
- If the cost submitted for the offer segment is greater than the Maximum Allowable Incremental Cost value, then the cost-based offer for that segment and all segments at an equal or greater price are deemed not verified. Such segments are capped at the greater of \$1,000/MWh or the price on the most expensive verified segment for the purposes of dispatch and setting LMP.
- PJM will notify the Market Seller of the verification status of each segment upon completion of the screen.
- Any subsequent update to a cost-based offer's incremental energy offer curve or no-load cost subjects the offer to the screening process upon submission of the update and the offer is capped based on the result of the updated screen.

Generation Resource Exception Process

If any segment of a resource's offer does not pass the offer screen, the Market Seller can submit an exception request. The exception process provides a Market Seller the ability to justify a resource's offer that did not pass the offer screen so that, if verified, it may be used in dispatch, be eligible to set LMP, or be eligible to receive Operating Reserve Credits. During the exception process, with timely input and advice from the MMU, PJM determines whether all segments of the resource's offer are compliant with the PJM approved Fuel Cost Policy for all applicable hours using documentation provided by the Market Seller via Markets Gateway detailing the underlying costs. Exception process requests will be evaluated in the order in which they are received. In the event that a particular request does not have sufficient information or documentation, or the documentation is not provided in a sufficiently timely and organized manner, PJM will put the request on hold and process the next requests in the queue.

- Market Sellers shall submit exception requests as documented on the Energy Offer Verification page on PJM.com. This process includes the completion of the Energy Offer Verification Exception Request form including all supporting documentation detailing the underlying costs via Markets Gateway's "Fuel Price Exceptions" tab . Necessary Documentation and Inputs for Verification of Exceptions include:
 - Annotated PJM-approved Fuel Cost Policy with applicable sections highlighted and a numerical cost calculation example applicable to the Operating Day and to the resource.
 - Prior submittal of all costs inputs in MIRA, or other system(s) made available for submission of such data, used to calculate the cost-based offer, other than the level of the cost of fuel.
 - Documentation supporting the level of the cost of fuel, as defined by the applicable documentation requirements in the Market Seller's PJM-approved Fuel Cost Policy. The Market Seller shall separately identify the levels of the commodity cost of fuel, and if appropriate, fuel transportation costs, other fuel charges and other applicable adders.
- Upon receiving the Energy Offer Verification Exception Request including necessary supporting documentation and any other relevant information available via Markets Gateway, PJM, with timely input and advice from the MMU, will review the information against the Market Seller's Fuel Cost Policy to verify accuracy of the offer. Based on the review PJM will take one of the following actions:
 - If the Market Seller does not provide complete information as described above by completing all steps in the Markets Gateway "Fuel Price Exceptions" tab or lacks supporting documentation, PJM is not able to consider the exception request while the information provided is incomplete. The Market Seller may then provide further documentation detailing the resource's underlying costs.
 - If the information and documentation is sufficient to validate the level of the cost-based offer, PJM will approve the exception and deem the offer verified. PJM will then notify the Market Seller of the verification result. The offer becomes eligible to be used as part of dispatch and calculating LMP as soon as the verification decision is recorded in the PJM market systems
 - If the information and documentation is insufficient to verify the level of the cost-based offer, PJM will deny the exception. For a denied exception, PJM will cap the cost-based offer at the greater of \$1,000/MWh or the highest segment verified in the exception process.

2.3.6.3 Fast-Start Capable Generation Resource Composite Energy Offer Screening Process for Composite Offers more than \$1,000/MWh

Before the components of a Fast-Start Capable generation resource's offer are considered in the calculation of LMPs, PJM uses a screening process to verify the reasonableness of each Composite Energy Offer in excess of \$1,000/MWh calculated at the submitted applicable

Economic Maximum and Minimum Run Time. In the event an hourly Economic Maximum or Minimum Run Time has been submitted, this will be used as the applicable Economic Maximum or Minimum Run Time; otherwise, the submitted Daily Offer will be used.

PJM will evaluate whether each Fast-Start Capable Resource's Composite Energy Offer greater than \$1,000/MWh exceeds the reasonably expected costs for that generation as follows:

1. PJM shall evaluate whether the Incremental Energy Offer and No-load Cost components exceed the reasonably expected costs for that resource as determined in accordance with the PJM Operating Agreement, Schedule 1, Section 6.4.3.
2. PJM shall evaluate whether the Start-Up Cost component exceeds the reasonably expected costs for that resource as determined in accordance with the PJM Operating Agreement, Schedule 1, Section 6.4.3A. If data required to calculate the reasonably expected startup costs is null or unavailable, the startup cost cannot be verified.

In addition, PJM will evaluate whether each Fast-Start Capable Resource's price-based Composite Energy Offer greater than \$1,000/ MWh exceeds the specified reference cost-based schedule as follows:

- The Start-Up Cost and the No-Load Cost for the price-based schedule is deemed to exceed the reasonably expected costs if the Incremental Energy Offer of the price-based schedule exceeds the Incremental Energy Offer of the specified reference cost-based offer.
- The Start-Up Cost for the price-based schedule is deemed to exceed the reasonably expected cost if it (1) exceeds the Start-Up Cost of the specified reference cost-based offer or (2) exceeds the reasonably expected costs for that resource as described above.
- The No-Load Cost for the price-based schedule is deemed to exceed the reasonably expected cost if it (1) exceeds the No-Load Cost of the specified reference cost-based offer or (2) exceeds the reasonably expected costs for that resource as described above.

For information on the how the results of the screening process are used in the determination of Composite Energy Offers, refer to Section 2.7 of this Manual.

2.3.7 Mechanical/Technical Rules

A valid generator offer consists of the following elements:

- Use startup & no-load switch, with a default value of yes (1).
- Hourly startup and no-load costs, with default values of zero.
 - External resources can only submit startup and no-load costs if the entire output of the resource is available for PJM dispatch.
- Condense available switch, with a default value of no (0).
- Ramp rate, with a default value of 9999 MW/minute.
- Hourly economic max/min and emergency max/min are the unit-level economic and emergency MW limits, respectively.

- Daily minimum down time and start times, with default values of zero.
- Daily minimum run time and notification time for the Day-ahead Market, with the ability to update the hourly values for use in Real-time commitment and dispatch. The default values will be zero.
- Daily maximum run time and maximum number of starts per week, with default values of infinity.
- Use offer slope switch, with a default value of no (0).
- Hourly incremental offer curves, with default value of \$0. If the last MW point on the segment curve is less than the maximum emergency limit, then the curve is extended up to the emergency maximum limit using zero slope from the last incremental point on the curve.
- For those parameters that are allowed to vary hourly, in the absence of overrides specifying separate values for each hour (hourly differentiated offer data), the daily offer value is used.
- In order to qualify for exempt or bonus MW during a Performance Assessment Interval, in accordance with PJM Manual 18: PJM Capacity Market, Section 8.4A Non-Performance Assessment, each generation resource must have at least one available schedule. Each offer must have the following:
 - Economic Minimum value (zero or non-zero value).
 - Economic Maximum value (zero or non-zero value).
 - Emergency Maximum value (zero or non-zero value).
 - At least one segment on the incremental offer curve.

Valid offers for a Generation Capacity Resource consists of a parameter limited price-based schedule (if the resource is price-based) and at least one cost-based schedule.

Valid offers for a non-Capacity Generation Resource consists of a price-based schedule (if the resource is price-based) and at least one cost-based schedule.

Valid offers for demand bids, price sensitive and fixed, consist of the following items:

- MW, with a default value of 0 MW. Demand bids should not include losses.
- Location (transmission zone, aggregate, or single bus). Price at which the demand shall be curtailed (for price-sensitive bids).

2.3.8 Modeling

Fixed transactions, including increment offers, decrement bids, and Up-To Congestion Transactions are modeled in the Resource, Scheduling & Commitment (RSC).

The Day-ahead security analysis treats increment offers as injections (generation) and decrement bids as withdrawals (loads).

External bilateral transactions sourcing at an interface bus are modeled as generation at the source bus location. This is the case for both dispatchable and non-dispatchable transactions.

External bilateral transactions sinking at an interface bus are modeled as a load at the sink bus location. This is the case for both dispatchable and non-dispatchable transactions.

Only fixed transactions and transactions involving external aggregate resources are modeled in the RSC for the Day-ahead Market.

2.3.9 Day-ahead Locational Marginal Price (LMP) Calculations

The following resources are eligible to set LMP values in the Day-ahead Market:

- All dispatchable units.
- Dispatchable external resource offers.
- Increment offers.
- Committed Economic Load Response bids.
- Price-sensitive demand bids and decrement bids.
- 'Up-to' congestion transactions.
- Generation resources with cost-based incremental energy offers in excess of \$2,000/MWh are dispatched in economic merit order but are capped at \$2,000/MWh for the purposes of calculating LMP.

2.3.10 Operating Parameter Definitions

Cold/Warm/Hot Notification Time - The time interval between PJM notification and the beginning of the start sequence for a generating resource that is currently in its cold/warm/hot temperature state. The start sequence may include steps such as any valve operation, starting feed water pumps, startup of auxiliary equipment, etc.

Cold/Warm/Hot Start-up Time - The time interval, measured in hours, from the beginning of the start sequence to the point after the generator breaker closure which is typically indicated by telemetered or aggregated state estimator MWs greater than zero for a generating resource in its cold/warm/hot temperature state. For a Combined Cycle unit it is the time interval from the beginning of the start sequence to the point after the first combustion turbine generator breaker closure which is typically indicated by telemetered or aggregated state estimator MWs greater than zero. The start sequence may include steps such as any valve operation, starting feed water pumps, startup of auxiliary equipment, etc.

Other more detailed actions that could signal the beginning of the start sequence could include but are not limited to the operation of pumps, condensers, fans, water chemistry evaluations, checklists, valves, fuel systems, combustion turbines, starting engines or systems, maintaining stable fuel/air ratios, and other auxiliary equipment necessary for startup.

Minimum Run Time (hour) - The minimum number of hours a resource must run, in Real-time operations, from the time after the generator breaker closure which is typically indicated by telemetered or aggregated state estimator MWs greater than zero to the time of the generator breaker opening, as measured by PJM's state estimator. For Combined Cycle units this is the time period after the first combustion turbine generator breaker closure (which is typically indicated by telemetered or aggregated state estimator MWs greater than zero) and the last generator breaker opening as measured by PJM's state estimator.

Turn Down Ratio – The ratio of a resource's economic maximum MW to its economic minimum MW.

Minimum Down Time (hour) - The minimum number of hours under normal operating conditions between resource shutdown and resource startup, calculated as the shortest time difference between the generator breaker opening and after the generator breaker closure, which is typically indicated by telemetered or aggregated state estimator MWs greater than zero. For Combined Cycle units this is the minimum number of hours between the last generator breaker opening and after the first combustion turbine generator breaker closure which is typically indicated by telemetered or aggregated state estimator MWs greater than zero.

Maximum Daily Starts - The maximum number of times that a resource can be started in an operating day under normal operating conditions.

Maximum Weekly Starts - The maximum number of times that a resource can be started in one week under normal operating conditions (168 hour period starting Monday 0001 hour).

Maximum Run Time (hour) - The maximum number of hours a resource can run over the course of an Operating Day as measured by PJM's state estimator.

Cold/Warm/Hot Soak Time (hour) - The minimum number of hours a resource must run, in Real-time operations, from the time after the generator breaker closure which is typically indicated by telemetered or aggregated state estimator MWs greater than zero to the time the resource is dispatchable. For Combined Cycle units this is the minimum number of hours from the time just after the first combustion turbine generator breaker closure which is typically indicated by telemetered or aggregated state estimator MWs greater than zero and the time the unit is dispatchable.

Soak Time may include items such as the time necessary to alleviate temperature gradients across boiler or turbine components, the startup and stable operation of environmental equipment, water chemistry evaluations and holds, the maintaining of stable fuel/air ratios, the addition of incremental fuel related or other auxiliary equipment, the starting of additional

combustion turbines in a combined cycle, and the pressure matching of heat recovery steam generators.

2.4 Real-time Market Operations

The Real-time Market Operations function consists of several programming modules resulting in the Real-time Locational Marginal Price (LMP) calculation. The following applications are used in the calculation of the Real-time LMP and Ancillary Service Market clearing prices:

- The Real-time Market Clearing Engines (ASO, IT SCED and RT SCED).
- PJM State Estimator.
- Locational Pricing Calculator (LPC).

Each of the applications are described in detail in Section 2.5 of this Manual.

2.5 Real-time Clearing Engines

To conduct the Real-time Markets, a multi-module software platform is utilized by PJM to dispatch Energy and ensure adequate Reserves in Real-time and Regulation in near time (see the image below). The Real-time Market Clearing Engines and various other applications communicate jointly and the most recent information from each application is stored, and upon request, provided to each application. To run the Real-time Market, data is processed from the markets database and other PJM systems.

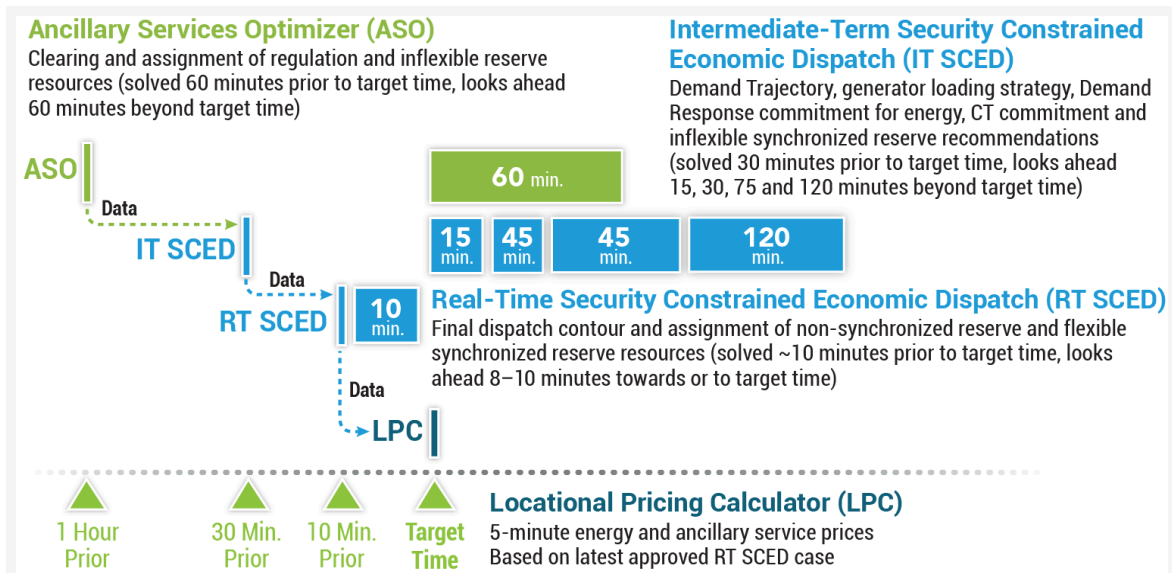

The applications jointly optimize the products for a defined target time to ensure that all system requirements are met using the least cost resource set therefore minimizing production cost.

2.5.1 Ancillary Service Optimizer (ASO)

The Ancillary Services Optimizer (ASO) performs the joint optimization function of Energy, Reserves and Regulation in the dispatch run. The main functions of ASO are the clearing and commitment of all Regulation resources and inflexible Reserve resources for a one hour time period. The ASO case is executed one (1) hour prior to the beginning of an operating hour and is normally solved and approved up to thirty (30) minutes prior to the operating hour. Upon case approval, the assignments are posted in the Markets Gateway system. In the event the ASO case is not approved, previous assignments are effective into the next hour. The ASO engine uses the hourly offers for Energy, Reserves and Regulation that are effective at the target time for each case solution and also performs the Regulation Three Pivotal Supplier Test. ASO does not calculate market clearing prices.

2.5.2 Intermediate Term Security Constrained Economic Dispatch (IT SCED)

The Intermediate Term Security Constrained Economic Dispatch (IT SCED) application is used by PJM to perform various functions over a 2 hour look-ahead period. Historical and current system information including forecasted energy transactions are used to anticipate generator performance to various requests, and to provide accurate information regarding generator operating parameters under multiple scenarios. The IT SCED solves a multi-interval, time-coupled solution to perform the following functions:

- Resource commitment recommendations for Energy and Reserves.
- Resource commitment decisions for economic Demand Resources.
- Execution of the Three Pivotal Supplier Test for Energy.
- Non-Synchronized Reserves Opportunity Cost.
 - Non-Synchronized Reserves Opportunity Cost from the pricing run solution is utilized in the NSR Offer Price in RT SCED.
- Coordinated Transaction Scheduling.
 - The ITSCED pricing run solution is used to produce interface LMPs which are exchanged with other ISOs/RTOs as part of the Coordinated Transaction Scheduling process. CTS evaluation in the ITSCED engine is based on the pricing run solution. All other ITSCED functions are based on the ITSCED dispatch run.
 - Additional detail regarding Coordinated Transaction Scheduling is in Section 7 of this manual.

The IT SCED engine uses the hourly offers for Energy, Reserves and Regulation that are effective at the target times for each case solution.

2.5.3 Real-time Security Constrained Economic Dispatch (RT SCED)

The Real-time Security Constrained Economic Dispatch (RT SCED) application is responsible for dispatching resources every five (5) minutes for a future target time in order to co-optimize Energy and Reserves at the target time based on forecasted system conditions. RTSCED performs a dispatch run solution. RTSCED does not perform a pricing run solution.

2.5.3.1 Real-time Security Constrained Economic Dispatch Optimization

The design of RT SCED is to develop an optimized dispatch using a common computer algorithm utilizing Linear Programming (LP) to meet the PJM objective of minimizing production costs while:

- Dispatching sufficient resources to meet the PJM Load Forecast
- Honoring physical transmission constraints on the PJM power system
- Honoring inflexible ancillary service assignments
- Committing sufficient flexible reserves to meet the PJM Real-time requirements

The steps utilized to meet the above goals in RT SCED are captured in a multi-step process as follows:

- Process PJM system Data Inputs as defined in Section 2.5.3.5 and Section 2.6 of this Manual
- Process network topology data – PJM physical topology representation of lines, breakers, transformers, etc...are converted into a computer model
- Process bid data – ensure bid data and schedule data is valid
- Process inflexible ancillary service assignments
- Identify and process active Operational emergency procedures
- Conduct LP calculations to solve for optimal dispatch solution and identify appropriate marginal resources

2.5.3.2 Real-time Security Constrained Economic Dispatch Marginal Resource Identification

Marginal resources are identified using a sub-gradient method via the Linear Programming (LP) solver. This iterative optimization algorithm is utilized for solving convex minimization problems.

The Marginal resources for energy and Transmission constraints are determined in parallel as follows:

- A perturbation MW is first added to the power balance constraint and the Marginal resources are identified.
- If the number of Marginal resources is less than N+1 (N is the number of binding or violated constraint(s)) then the perturbation will be added on to each binding or violated generic constraint one by one.
 - The marginal clearing price of the Regulation service is calculated with ranking prices so the Marginal resource for Regulation is identified manually when its ranking price is equal to Regulation Marginal Clearing Price.

After the Marginal resources for energy and Transmission constraints are determined, the Marginal resources for ancillary services are identified as follows:

- A perturbation MW is applied to each locale.

- To identify the Marginal resource for Regulation the sub-gradient methodology is not utilized.
 - The marginal clearing price of the Regulation service is calculated with ranking prices so the Marginal resource for Regulation is identified manually when its ranking price is equal to Regulation Marginal Clearing Price.

Lastly, the Marginal resources are identified as the following:

- Energy is defined as the resource(s) reflecting an energy withdrawal at a location and is the resource(s) whose co-optimized energy output and Ancillary Services (AS) clearing change as the energy withdrawal changes.
- Transmission constraints are defined as the resource(s) reflecting transmission constraints and is the resource(s) whose energy output and AS clearing change as transmission constraint limit changes.
- Ancillary Services is defined as the resource(s) reflecting a system or zonal AS requirement and is the resource(s) whose co-optimized AS clearing and energy output change as the AS requirement changes.

2.5.3.3 Real-time Security Constrained Economic Dispatch Methodology

The future target dispatch time or target time is eight (8) to ten (10) minutes from the program's execution time rounded up to the nearest five (5) minute segment of time. The ten (10) minute future target dispatch time is divided into two five (5) minute segments. During the initial five (5) minute segment, RT SCED shall calculate an Achievable Target Megawatt (ATM), which utilizes the previous dispatch instructions, latest State Estimator (SE) data and bid in operating parameters to determine where the unit is most likely to be operating at the end of the first five minutes.

The ATM is calculated by determining an achievable output band, which takes the reported SE MW value (represents where the unit is operating) and uses the bid in ramp rates to determine where the unit can get to in the next five minutes.

- When the previous dispatch instruction is within the achievable output band, the ATM is set to the previous dispatch MW value.
- When the previous dispatch instruction is below the achievable output band, the ATM is set to the floor of the achievable output band.
- When the previous dispatch instruction is above the achievable output band, the ATM is set to the ceiling of the achievable output band.
- If previous dispatch instructions are not available, the ATM is set to the SE MW value.

The second five (5) minute segment uses the calculated ATM as a starting point, and ramps the resource over the remaining five (5) minute time period to meet the load and reserves.

The general formula is as follows:

- $Achievable\ Target\ MW = \min(\max(\text{previous Case Dispatch}, (SE\ MW - (\text{current down ramp rate}) * 5)), (SE\ MW + (\text{current up ramp rate}) * 5))$

- Where:

Previous case dispatch: Dispatch Signal from the previous approved RTSCED case

SE MW: State Estimator output

Current Down Ramp Rate: Down ramp rate determined at the time the Real-time case is executed

Current Up Ramp Rate: Up ramp rate determined at the time the Real-time case is executed

- The following diagrams illustrate this process:

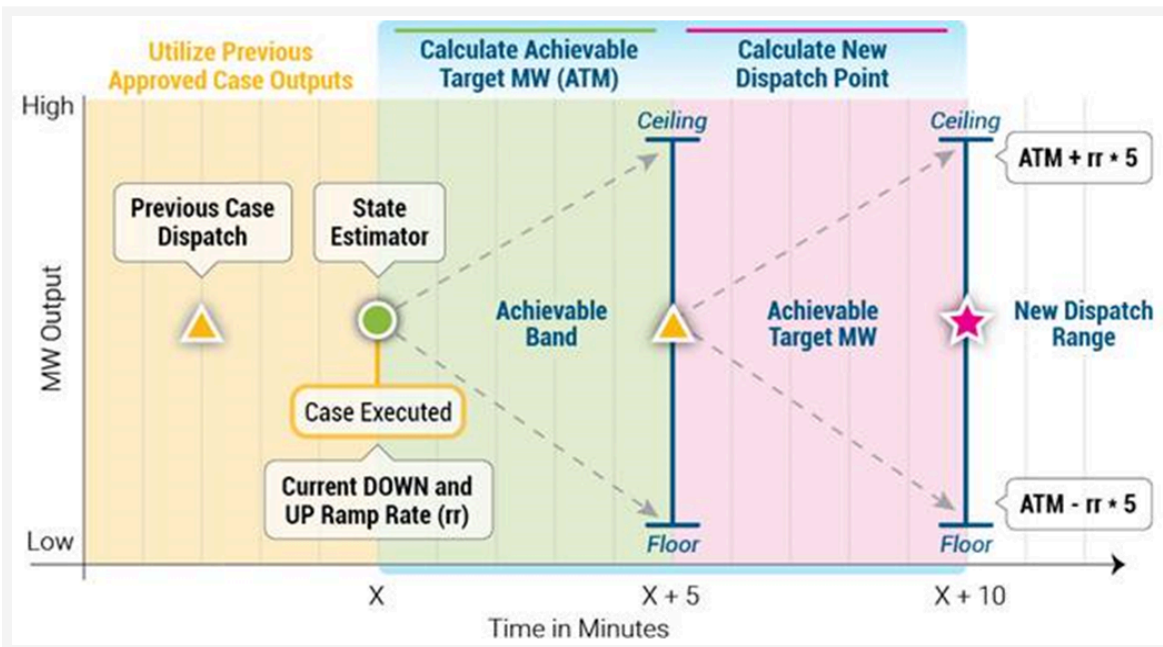

In this example, RT SCED executes a case at X minutes (indicated by the green circle). Simultaneously, RT SCED “looks back” at the previous RT SCED case dispatch basepoint (indicated by the yellow triangle) to determine whether the unit can achieve the instruction. Because the previous RT SCED case dispatch basepoint is within the achievable output band (indicated by the grey arrows in the green segment), RT SCED will use the previous dispatch basepoint as the starting point for the second five-minutes (the dispatch interval), and ramp up or down as necessary within the resulting feasible range (indicated by the grey arrows in the pink segment) over the subsequent five minutes.

If RT SCED “looks back” and determines that the resource’s previous dispatch basepoint is not within the achievable band, RT SCED will use a new dispatch basepoint as the starting point for the second five minutes, which will be either the “ceiling” or the “floor” of the achievable band

from the first five minutes depending on whether the previous instruction was above or below the achievable band. These scenarios are illustrated by the following diagram.

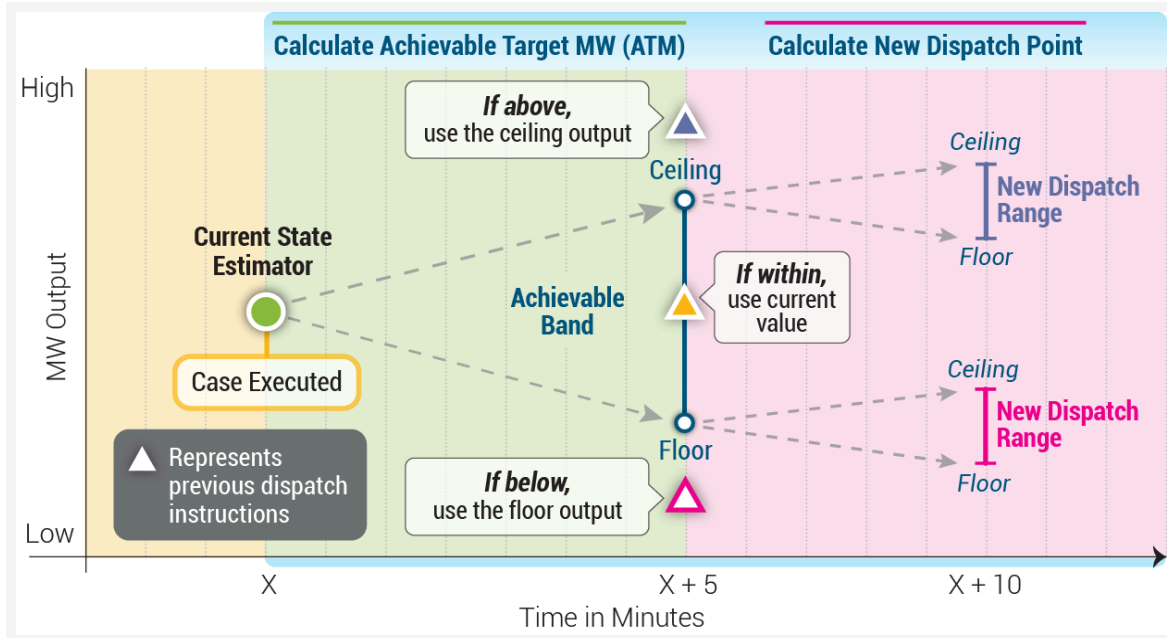

In this example, RT SCED “looks back” over the previous interval, and determines that the previous dispatch basepoint is above the “ceiling” of its achievable output band (indicated by the purple triangle and grey arrows in the green segment). As a result, RT SCED establishes the “ceiling” of the achievable band as the new dispatch basepoint for the second five-minute segment of the ten-minute look-ahead, and creates a new dispatchable range (indicated by the grey arrows in the upper half of the pink segment). A parallel example using the “floor” is also illustrated for reference.

Historical and current system information is used to anticipate generator performance to various requests, and to provide accurate information regarding generator operating parameters under multiple scenarios.

The results from the approved RT SCED are Energy Dispatch Signals, Synchronized Reserve commitments, Non-Synchronized Reserve commitments, and Secondary Reserve commitments are sent to resource owners in Real-time. All dispatch instructions may change with each solution based on system economics and reserve requirements.

Reserve MW assignments are derived from the latest approved Real-time Security Constraint Economic Dispatch (RT SCED) program solution for the target time at the end of the current five (5) minute interval. If there is not an approved RT SCED solution for the target time at the end of the current five (5) minute interval, the reserve MW assignments will use the most recently approved RT SCED solution prior to the target time as the reference case for LPC.

2.5.3.4 Real-time Security Constrained Economic Dispatch Timeline and Instruction Set

A RT SCED dispatch case is executed automatically every five (5) minutes or when manually executed by the operator at least eight (8) to ten (10) minutes prior to a target time. All generators are expected to follow the dispatch signals upon approval of the RT SCED dispatch solution every five (5) minutes. Shortly after the dispatch signals are sent out, the prices for those dispatch signals are calculated by the Locational Pricing Calculator (LPC) as further defined in Section 2.7 of this Manual and are posted online. The dispatch and prices are effective for the next five (5) minutes or until a new RT SCED case is approved. This timeline is depicted in the figure below.

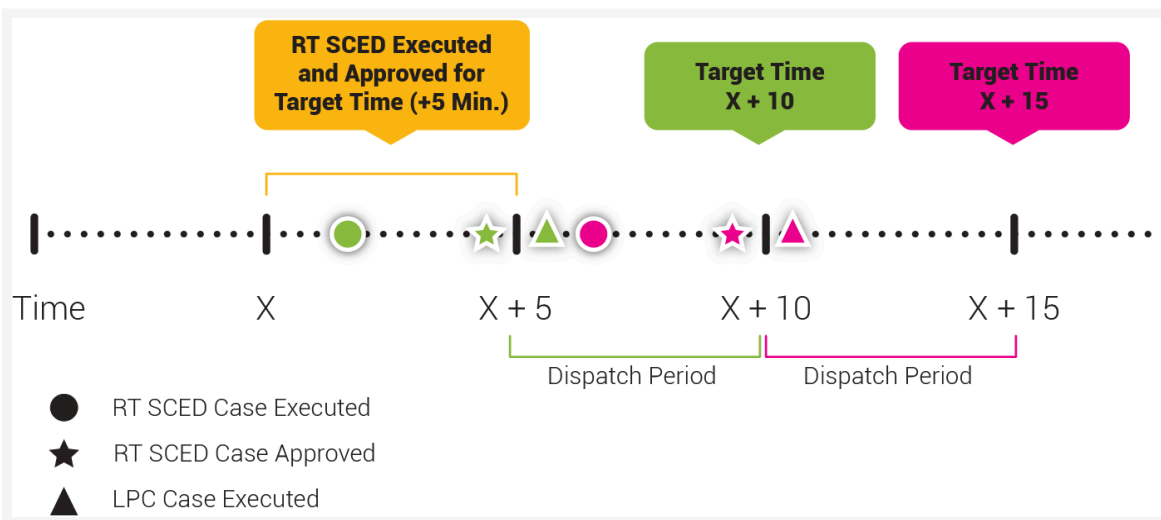

Exceptions:

In some events a case may not be approved due to a failure of the RT SCED software or for an operational reason. Furthermore, in some rare instances, a second case may be approved for the same target time to address a reliability based operational concern.

These events include but are not limited to the following categories:

- Data Inputs – This is defined as any input into the RT SCED optimization. (e.g. Load Forecast).
- IT Technical Issues – This is defined as any type of hardware, network or software failure (e.g. server).
- System conditions – This is defined as any type of power system event (e.g. generator trip).

2.5.3.5 Real-time Security Constrained Economic Dispatch Inputs

Each RT SCED case produces multiple solutions using different forecasted load bias values entered by the PJM Dispatcher. To calculate the solution, data from multiple sources is used, including but not limited to, data regarding online and available resources, resource offers, forecasted load, scheduled interchange, as well as various other input parameters effective for the period ending at the future dispatch target time. For example, resource offers, Regulation and Inflexible Synchronized Reserve assignments from the 11:00 to 12:00 will be effective until the 12:00 future dispatch target time. Resource offers and Regulation and Inflexible Synchronized Reserve assignments for the 12:00 to 13:00 will be used as input to RT SCED for the future dispatch target time of 12:05 and onwards until 13:00. The RT SCED cases utilize the forecasted load and other system information that are effective for the future dispatch target time, rather than the time at which the case is executing, to achieve a dispatch solution that will adequately control for those forecasted conditions.

Real-time data sources include:

- Load forecast data.
- Wind forecast data.
- Hydropower Schedules as defined in Section 3.2.8.1 of this Manual.
- Constraint data – resource sensitivities.
- State Estimator output.
- Loss Penalty Factors.
- Transaction data from ExSchedule.
- Regulation and Inflexible Reserve commitments.
- Generator and Economic Load Response operating parameters and offer data.

Multiple RT SCED solutions are produced, with each solution solving the security constrained economic dispatch problem. Each of these solutions contains:

- A set of zonal dispatch rates.
- Dispatch rates reflecting constraint control.
- Individual resource dispatch rates.
- Individual resource Dispatch Signal.
- Individual resource reserve commitments.
 - Maintains inflexible reserves assignments from ASO.
 - Assigns flexible Reserves.
- Individual resource regulation assignments.

A subset of the solved RT SCED solutions are approved to send Dispatch Signals to online resources. Each resource owner or Market Operations Center (MOC) is expected to comply

with the energy dispatch signals sent by each RT SCED solution in accordance with the PJM Tariff and Operating Agreement.

2.6 PJM State Estimator

The RT SCED solution depends upon having a complete and consistent power flow solution as an input.

The state estimator is a standard power system operations tool whose purpose is to provide a base case power flow solution for input into other computer programs. It depends upon data redundancy and the underlying physical and mathematical relationships of the power system to provide a solution with less error than the original measurements. Therefore the state estimator can correct “bad data” and calculate missing data in the model to provide a consistent representation of existing network conditions.

The inputs to the state estimator are the available (metered) Real-time measurements, the current status of equipment (lines, generators, transformers, etc.), and the bus model (impedance, parameters, etc.). The state estimator uses actual operating conditions that exist on the power grid (as described by metered inputs) along with the fundamental power system equations to calculate bus voltage and angle and flows based on metered data. Since the state estimator solution provides a complete and consistent model of actual operating conditions based upon metered input and an underlying mathematical model, it can be used to provide the basis for RT SCED case solutions.

A new state estimator solution is typically available every minute to RT SCED and can provide the following inputs:

- AC power flow solution.
- Actual generator MW output.
- Bus loads.
- Tie-line flows.
- MW losses by transmission zone.
- Actual MW flow on any constrained transmission facility.

2.7 Locational Pricing Calculator (LPC)

The function of the Locational Pricing Calculator (LPC) is to determine the Real-time LMP values and Regulation and Reserve Clearing Prices on a five (5) minute basis. The LPC engine performs a pricing run solution where Integer Relaxation is applied to eligible Fast-Start resources only for the purposes of calculating LMPs and Ancillary Service MCPs. Real-time LMPs and Regulation and Reserve Clearing Prices are derived from the inputs of the latest approved Real-time Security Constrained Economic Dispatch (RT SCED) program solution,

referred to as the reference case, for the target time at the end of the current five (5) minute interval.

If there is not an approved RT SCED solution for the target time at the end of the current five (5) minute interval, LPC will use the most recent approved RT SCED solution prior to the target time as the reference case. LPC will use the offered in parameters for Energy and Reserves from the reference case as inputs as well as offered in parameters for Regulation that are effective at the target time for each LPC case solution. The Real-time LMPs and Regulation and Reserve Clearing Prices calculated by LPC are applied to each five (5) minute Real-time Settlement Interval ending at the LPC target time. In the event of an outage to RT SCED, LPC will use the RT SCED case that best represents the conditions over the outage period as determined by the Market Operator.

The LPC calculates LMPs for each of the PJM nodes in the state estimator model and for interface busses used as a proxy for transfers to and from PJM and external control areas. The Real-time LMPs are defined as the cost to serve the next increment of load at each node, in the LPC pricing run, taking into account eligible resource Real-time offer prices and the nodes' location with respect to transmission limitations and incremental system losses.

The LPC is an incremental linear optimization program that is formulated to jointly optimize and price both Energy and Reserves. The objective is to minimize the cost function including the cost of Energy and Reserves subject to the power balance constraint, the Synchronized, Primary, and 30-minute Reserve Requirements, specific generator and Demand Resource operating limitations, except in cases in which Integer Relaxation is applied, transaction MW limits, and any transmission constraints that currently exist on the system and a normalized distribution of system losses to a network location.

Every five (5) minutes the LPC calculates:

- Locational Marginal Prices (LMPs).
- Synchronized Reserve Market Clearing Prices (SRMCPs).
- Non-Synchronized Reserve Market Clearing Prices (NSRMCPs).
- Secondary Reserve Market Clearing Prices (SecRMCPs)
- Regulation Market Clearing Prices (RMCPs) and Regulation Market Performance Clearing Prices (RMPCP), which are then used to derive the Regulation Market Capability Clearing Price (RMCCP).

Each Energy and Reserve clearing price is calculated as the cost to serve the next MW of demand for each individual product considering its impact on the others. For example, LMPs are calculated such that they reflect the cost to serve the next MW of Energy demand in each location while considering the impact of that additional MW of Energy on the ability to meet the Primary Reserve, Synchronized, and 30-minute Reserve Requirements. Regulation Clearing Prices are calculated as the cost of the last resource committed to meet the Regulation Requirement, as further described in Section 3 of this Manual.

2.7.1 Energy Offers used in Real-time Price Calculation

As described in Section 2.1 of this Manual, Real-time economic dispatch is performed in the Real-time security constrained economic dispatch software program, known as the dispatch run. Real-time prices are calculated in a subsequent execution of the Locational Pricing Calculator (LPC) software program, known as the pricing run. The pricing run executes the same optimization as the dispatch run but additionally applies Integer Relaxation to Eligible Fast-Start Resources. Integer Relaxation is the process by which the commitment status for an Eligible Fast-Start Resource is allowed to vary between zero and one, inclusive of zero and one.

Real-time prices shall be determined for every five (5) minutes, using the applicable marginal energy offer of the resources being dispatched using the offer schedule on which the resource is committed in the dispatch run. PJM will determine a resource's applicable marginal energy offer by comparing the megawatt output of the resource from the pricing run with the Market Seller's Incremental Energy Offer curve or, for Eligible Fast-Start Resources, the Market Seller's Composite Energy Offer. For Eligible Fast-Start Resources, the amortized Start-Up Costs and amortized No-Load Costs, expressed in dollars per megawatt-hour, are added to the resource's Incremental Energy Offer to determine a Composite Energy Offer, as described below:

- The amortized Start-Up Cost for a generation resource equals the resource's applicable Start-Up Cost amortized over (A) the resource's Economic Maximum or Emergency Maximum output, whichever is applicable and (B) the resource's Minimum Run Time. The Emergency Maximum output will only be used for amortization when PJM Operations declares calling on offline emergency resources or declares deploying emergency segments on online resources. The amortized Start-Up Cost is included in the resource's Composite Energy Offer during the resource's Minimum Run Time rounded up to the nearest twelfth of an hour. After the Minimum Run Time has been met, the amortized Start-Up Cost is not included in the Composite Energy Offer.
 - If the Minimum Run Time is less than five (5) minutes, the Minimum Run Time used to calculate the amortized Start-Up Cost is five (5) minutes and the amortized Start-Up Cost is added to the Incremental Energy Offer for the first five (5) minute interval in which the resource runs.
 - To determine the amortized Start-Up Costs for Economic Load Response Participant resources, the Minimum Down Time is used in place of the Minimum Run Time and shutdown cost is used in place of Start-Up Cost in the above equation.
 - The Amortized Start-Up Cost will be adjusted from in the Composite Energy Offer, as described in Section 2.7.3 of this Manual, if the resource exceeds the reasonably expected cost during the Offer Verification screening process as described in Section 2.6.3.3 of this Manual.
- The amortized No-Load Cost equals the resource's applicable No-Load Cost, amortized over the resource's Economic Maximum or Emergency Maximum output, whichever is applicable, and included in the Composite Energy Offer for all intervals in which the generation resource is pool-scheduled.

- The amortized No-Load Cost will be adjusted in the Composite Energy Offer, as described in Section 2.7.3 of this Manual, if the resource exceeds the reasonably expected cost during the Offer Verification screening process as described in Section 2.6.3.3 of this Manual.
- For purposes of calculating Real-time Prices, the applicable marginal Incremental Energy Offer used in the calculation of Real-time Prices shall not exceed \$2,000/MWh.
- If a generation resource that is an Eligible Fast-Start Resource submits an offer that results in a Composite Energy Offer with a maximum segment that exceeds \$2,000/MWh then the amortized Start-Up Cost may be adjusted from the determination of the Composite Energy Offer. If the resulting Composite Energy Offer is still in excess of \$2,000/MWh, then the amortized No-Load Cost shall may be adjusted from the determination of the Composite Energy Offer.
- If an Economic Load Response Participant resource that is an Eligible Fast-Start Resource submits an offer that results in a Composite Energy Offer with a maximum segment that exceeds \$2,000/MWh then the amortize shutdown cost may be adjusted from the determination of the Composite Energy Offer.

All Fast-Start resources, with the exception of self-scheduled resources that specify intent to not follow dispatch, are eligible to set LMP.

2.7.2 Determination of LMPS for De-Energized Busses

Due to equipment outages, the main transmission system may contain some de-energized busses for which LMPs cannot be directly calculated. It is necessary for settlement purposes that LMPs for these de-energized busses be established. The methodology for determining LMPs at de-energized busses is to assign to them the LMPs at their neighboring energized busses. In the Day-ahead and Real-time Markets, the Dijkstra algorithm is automatically executed to find a suitable source for a de-energized bus using the least impedance path. In Day-ahead, it is necessary to re-energize the bus to determine these prices.

If no energized bus is found using the automated logic, the PJM Market Operator is notified that a de-energized bus exists and is required to manually search for a suitable replacement. PJM Market Operators also reviews the suitability of the replacements selected by the Market Clearing Engine, and in cases where modeling discrepancies cause the selection of a sub-optimal replacement, may elect to use a more suitable replacement.

2.7.3 Determination of Energy Offers for Generation Resources with Composite Energy Offers greater than \$1,000/ MWh and equal to or below \$2,000/MWh

When a Fast-Start capable resource submits a Composite Energy Offer that exceeds \$1,000/MWh but is below \$2,000/MWh at the resource's Economic Maximum value, the components that make up the offer are verified for reasonableness as described in Section 2.3.6.3 of this Manual.

If the submitted components of the Composite Energy Offer are deemed not reasonable, adjustments are made to ensure the resulting Composite Energy Offer is no less than \$1,000/MWh or the sum of the verified offer components as described in the PJM Operating Agreement, Schedule 1, Section 2.4. The chart below describes how the Composite Energy Offer components may be adjusted in the event the Start-Up and/or No-load cost exceed (fail) or do not exceed (pass) the reasonably expected cost for the determination of LMPs.

Scenario	Submitted Composite Energy Offer at EcoMax (\$/MWh)	Submitted Incremental Energy Offer ("IEO")	Reasonability Test Results		Composition of Composite Energy Offer*	Adjustment and/or Offer Capping
			Submitted Start-Up Cost	Submitted No-load Cost		
1	≤ \$1,000	≤ \$1,000	N/A	N/A	IEO + ASU + ANL	No Offer Verification Trigger
2	\$1,000 < Offer ≤ \$2,000	≤ \$1,000	Pass	Pass	IEO + ASU + ANL	None
3	\$1,000 < Offer ≤ \$2,000	≤ \$1,000	Pass	Fail	IEO + ASU + adjustment (If needed)	Cap at the higher of \$1000 or IEO + ASU; No-load Cost may be included to cap offer at \$1,000
4	\$1,000 < Offer ≤ \$2,000	≤ \$1,000	Fail	Pass	IEO + ANL + adjustment (If needed)	Cap at the higher of \$1000 or IEO + ANL; Start-Up Cost may be included to cap offer at \$1,000
5	\$1,000 < Offer ≤ \$2,000	≤ \$1,000	Fail	Fail	IEO + Adjustment (If needed)	IEO Offer plus No-load Cost, up to submitted value to cap Composite Energy Offer to \$1,000; Use Start-Up Cost, if additional cost are needed.
6	\$1,000 < Offer ≤ \$2,000	\$1,000 < Offer ≤ \$2,000	Pass	Pass	IEO + ASU + ANL	None
7	\$1,000 < Offer ≤ \$2,000	\$1,000 < Offer ≤ \$2,000	Pass	Fail	IEO + ASU	None
8	\$1,000 < Offer ≤ \$2,000	\$1,000 < Offer ≤ \$2,000	Fail	Pass	IEO + ANL	None
9	\$1,000 < Offer ≤ \$2,000	\$1,000 < Offer ≤ \$2,000	Fail	Fail	IEO	Incremental is verified above \$1000, no additional cost are added

*The Start-Up Cost and No-load Cost included in a Composite Energy Offer will be at their amortized value. In this chart, "ASU" represents amortized Start-Up Cost, "ANL" represents amortized No-load Cost. Please refer to Section 2.7.1 for how the amortization process applies to the Start-Up and No-Load costs.

2.7.4 Determination of Energy Offers for Generation Resources with offers greater than \$2,000/MWh

Generation resources with cost based Incremental Energy Offers in excess of \$2,000/MWh are dispatched in economic merit order but are capped at \$2,000/MWh for the purposes of calculating LMP.

2.7.5 Determination of Energy Offers for Composite Energy Offers Greater than \$2,000/MWh

When a Fast-Start capable generation resource submits a Composite Energy Offer with a maximum segment that exceeds \$2,000/MWh, the components that make up the offer are verified for reasonableness as described in Section 2.3.6.3 of this Manual. Based on the results of the reasonableness verification, adjustments are made to ensure the resulting Composite Energy Offer is no greater than \$2,000/MWh as described in the PJM Operating Agreement, Schedule 1, Section 2.4.

The chart below describes how the Composite Energy Offer components may be adjusted in the event the Start-Up and/or No-load cost exceed (fail) or do not exceed (pass) the reasonably expected cost for the determination of LMPs.

Scenario	Submitted Composite Energy Offer at EcoMax (\$/MWh)	Submitted Incremental Energy Offer ("IEO")	Reasonability Test Results		Composition of Composite Energy Offer*	Adjustment and/or Offer Capping
			Submitted Start-Up Cost	Submitted No-load Cost		
1	> \$2,000	≤ \$1,000	Pass	Fail	IEO + ASU + adjustment (If needed)	1) IEO + ASU or 2) If Incremental + ASU ≤ \$1,000, cap at \$1,000; Add ANL to cap at \$1000, if needed 3) If Incremental + ASU > \$2,000, cap at \$2,000; Adjust down ASU to cap offer at \$2000
2	> \$2,000	≤ \$1,000	Fail	Pass	IEO + ANL + adjustment (If needed)	1) IEO + ANL or 2) If Incremental + ANL ≤ \$1,000, cap at \$1,000; Add ANL to cap at \$1000, if needed 3) If Incremental + ANL > \$2,000, cap at \$2,000; Adjust down ANL to cap offer at \$2000
3	> \$2,000	≤ \$1,000	Fail	Fail	IEO + adjustment (If needed)	Cap Composite Energy Offer at \$1,000; first include ANL up to submitted No-load Cost and if needed, include ASU until Composite Energy Offer = \$1,000
4	> \$2,000	≤ \$1,000	Pass	Pass	IEO + ASU + ANL	Cap Composite Energy Offer at \$2,000; adjust down ASU first to zero, ANL, until Composite Energy Offer equals \$2,000.
5	> \$2,000	> \$1,000	Pass	Pass	IEO + ASU + ANL	If IEO+SU+NL is greater than \$2000, Cap Composite Energy Offer at \$2,000; adjust down ASU first to zero, then ANL down to zero, until Composite Energy Offer equals \$2,000.
6	> \$2,000	> \$1,000	Pass	Fail	IEO + ASU	Exclude ANL from Composite Energy Offer, if resultant Composite Energy Offer > \$2,000 then cap Composite Energy Offer at \$2,000 by adjusting Start-Up Cost
7	> \$2,000	> \$1,000	Fail	Pass	IEO + ANL	Exclude ASU from Composite Energy Offer, if resultant Composite Energy Offer > \$2,000 then cap Composite Energy Offer at \$2,000 by adjusting No-load Cost
8	> \$2,000	> \$1,000	Fail	Fail	IEO	Exclude ASU and ANL from Offer, Composite Energy Offer = IEO, since IEO above \$1,000

*The Start-Up Cost and No-load Cost included in a Composite Energy Offer will be at their amortized value. In this chart, "ASU" represents amortized Start-Up Cost, "ANL" represents amortized No-load Cost. Please refer to Section 2.7.1 for how the amortization process applies to the Start-Up and No-Load costs.

2.8 The Calculation of Locational Marginal Prices (LMPs) During Emergency Procedures

In order to properly calculate LMPs during Emergency Procedures, PJM performs the following functions to ensure that deployed or purchased emergency capacity is eligible to set LMPs within PJM.

Pre-Emergency and Emergency Demand Response

- Pre-Emergency or Emergency Demand Response are deployed by lead time, by product, and/or by transmission zone or transmission subzone.
- PJM dispatches the resources of all Pre-Emergency or Emergency Load Response Program participants (not already dispatched under the Economic Load Response Program) based on the availability, location, dispatch price and/or quantity of load reduction needed, subject to transmission constraints in the PJM Region.
- To give PJM dispatchers the flexibility to address reliability concerns in the most effective and timely manner and invoke the resources that offer the most assurance of effective relief of emergency conditions, the dispatch of Demand Resources may not be solely based on the least-cost resources since such dispatch shall be based not only on price, but also on availability, location and/or quantity of megawatts of load or load reduction needed.
 - Resources in the Full Program Option and Energy Only Option in the Pre-Emergency or Emergency Load Response Program are eligible to set the Real-time LMP when PJM has dispatched the resources and such resources are required to reduce demand in the PJM Region.
 - PJM treats Pre-Emergency and Emergency Demand Response similar to a dispatchable generator for the purpose of determining whether it is marginal.
- PJM uses operational data submitted by CSPs to determine the availability and actual response of Pre-Emergency and Emergency Load Response.

Maximum Emergency Generation

- Generators who have designated all or portions of the output of their unit as max emergency are eligible to set price.
- Max emergency output is only eligible to set LMP if PJM Operators have loaded Maximum Emergency Generation.

Emergency Purchases

- PJM allows emergency purchase transactions to set LMP to the extent they are required to clear the Energy and Reserve Markets.
- Emergency Purchases are treated similar to the dispatchable generator for the purpose of determining whether they are marginal or not.

- If determined to be marginal, an Emergency Purchase sets price at the lesser of its offer price or the applicable offer cap stated in Section 2.3.2 of this Manual.

In the event that PJM initiates a voltage reduction or manual load dump to maintain system reliability:

- All Reserve Clearing Prices in the region where the voltage reduction and/or manual load dump were initiated are set consistent with a shortage of the first step on the demand curve.
 - Synchronized Reserve Clearing Price = Synchronized Reserve Penalty Factor + Primary Reserve Penalty Factor + 30-minute Reserve Penalty Factor (capped at 2 * Penalty Factor)
 - Non-Synchronized Reserve Clearing Price = Primary Reserve Penalty Factor + 30-minute Reserve Penalty Factor (capped at 1.5 * Penalty Factor)
 - Secondary Reserve Clearing Price = 30-Minute Reserve Penalty Factor

The LMPs and Reserve Clearing Prices in the location that the voltage reduction and/or manual load dump was initiated are calculated consistent with all reserve products in that region being short until such emergency conditions are terminated as defined in PJM Manual 13: Emergency Operations.

Shortage pricing is terminated in a Reserve Zone or Reserve Sub-Zone when demand and Reserve Requirements can be fully satisfied with generation and Demand Resources and any Voltage Reduction Action and/or Manual Load Dump Action taken for that Reserve Zone or Reserve Sub-Zone is terminated as determined by the Locational Pricing Calculator.

2.9 Shortage Pricing

If during the execution of the pricing run, the Locational Pricing Calculator determines that a Reserve Shortage exists as further described in Sections 2.8, 4.3 and 4.4 of this Manual, PJM shall deem the interval to be in a Reserve Shortage. PJM shall implement shortage pricing through the inclusion of the applicable Reserve Penalty Factors in the Real-time LMP and reserve pricing calculations.

Shortage pricing shall exist until the Locational Pricing Calculator determines the specified Reserve Requirements can be met and no Voltage Reduction Action or Manual Load Dump Action is still in effect.

If a Reserve Shortage exists and cannot be accurately forecasted by PJM due to a technical problem with or malfunction of the RT SCED and/or LPC software programs, including but not limited to program failures or data input failures, PJM utilizes the best available alternate data sources to determine if a Reserve Zone or Reserve Sub-Zone is experiencing a Reserve Shortage.

All shortages observed in the LPC pricing run will be provided to settlements for billing purposes.

The maximum energy component of LMP achievable during a Reserve Shortage is the \$2,000/MWh energy offer cap, plus \$1,700/MWh (two times Penalty Factors from the first step on the demand curves).

2.9.1 Calculation of Shortage Pricing LMPs

When PJM determines, via the LPC Pricing run, that there are not enough Reserves to meet the Reserve Requirements at a price less than or equal to the associated penalty factors, i.e. a Reserve Shortage, the penalty factor(s) for the deficient reserve product(s) are used in the determination of LMPs in the region where the shortage occurred.

- The methodology for calculating LMPs is consistent during periods of adequate Reserves and during Reserve Shortages.
- When Reserve Requirements can be met at a price less than or equal to the defined penalty factors, the penalty factors do not impact the calculation of LMPs.
- When any Reserve Requirement cannot be met at a price less than or equal to the defined penalty factor, the applicable penalty factor(s) is used in the determination of LMPs.
- The maximum LMP achievable during a Reserve Shortage is the \$2,000/MWh energy offer cap, plus \$1700/MWh (two times the Reserve Penalty Factor from the first step on the demand curves), plus or minus congestion and marginal loss impacts.

All LMPs calculated during a Reserve Shortage are based on the LPC pricing run.

2.10 PJM Real-time Price Verification Procedure

During and after each Operating Day, PJM reviews all of the five (5) minute Locational Marginal Prices (LMPs) and Ancillary Service Market Clearing Prices (MCPs) prior to finalizing the LMPs and MCPs for posting and use in settlements. The objective of price verification is to ensure prices reflect how the system was dispatched. If there are any instances where the five (5) minute price intervals do not reflect the dispatch of the system with incorrectly calculated five (5) minute LMPs and/or MCPs, PJM corrects those five (5) minute intervals during the Price Verification Procedure. In the event of a data input failure, program failure, data input discrepancy or logging error, corrective actions may be taken to ensure that the resulting Real-time LMPs and MCPs are as reasonably accurate and reflect the dispatch of the system as appropriate. Additional details describing scenarios in which LMPs and MCPs may be recalculated are listed below.

- Data Input Failures – May occur when telecommunication problems exist either internally on the PJM network or on the data paths between PJM and PJM members. If the failure occurs on the PJM network, PJM takes all possible steps to recover the original data for use in LMP and MCP calculation reruns. Examples of data input failures include, but are

not limited to, stale offer data, stale dispatch runs, Business Service Process (BSP) failures and stale EMS data.

- Program Failures - In the event of a program failure, PJM first attempts to correct the reason for the failure and recalculates LMPs and MCPs for the affected intervals. If the attempt fails to recover the original data, PJM utilizes data from the best available alternate data sources including, but not limited to, backup systems, dispatcher logs, raw telemetry data, and member company data sources. In the event of an inability to correct the failure, PJM uses data from a neighboring interval and recalculates LMPs and MCPs for the affected interval(s). Examples of program failures include, but are not limited to, State Estimator failure, RTSCED failure or LPC failure.
- Logging Errors - Transmission Constraint logging and resource logging errors can affect pricing. The reference for logging times is the transmission dispatcher manual log. In the event of a logging error, LMPs or MCPs are recalculated as outlined below:
 - Transmission constraint or resource logs entered or removed with a delay of less than four LPC intervals – No recalculation of LMPs and MCPs is required.
 - Transmission constraint or resource logs entered or removed with a delay of four LPC intervals or more – PJM corrects the constraint and/or resource data and recalculates LMP and MCPs.
 - Transmission constraint or resource logs entered incorrectly – PJM corrects the constraint and/or resource data and recalculates LMPs and MCPs.
- Data Input Errors – Data input errors can occur when applications or processes upstream of the LMP and MCP calculation complete successfully but produce erroneous results. These errors may include but are not limited to: errors with the Energy Management System (EMS) inputs such as distribution factors and loss sensitivity factors, constraint modeling errors that result in pricing that is inconsistent with the way PJM operators are managing a constraint, unintentional approval of the RT SCED case for which the LPC case runs and produces LMPs and MCPs, and Regulation Performance Score Calculation Engine (PSCE) related errors. In the event of a data input error, LMPs and MCPs are recalculated as outlined below:
 - If PJM determines EMS data, such as distribution factors or loss sensitivity factors, is erroneous such data is replaced with that from a surrounding interval and LMPs and MCPs are recalculated, or the LMPs and MCPs of the impacted nodes are replaced with those from electrically equivalent nodes when the number of nodes impacted is limited.
 - If modeled constraints in the upstream applications are inconsistent with how PJM operators are managing the constraint, PJM corrects the modeling of the constraint in the LPC case inputs and recalculates the LMPs and MCPs.
 - If an erroneously approved RT SCED case is the basis of an LPC case that produces LMPs and MCPs, PJM recalculates LMPs and MCPs using the last valid approved RT SCED case.

- If stale or missing regulation mileage or other Ancillary Service related data error is detected, PJM recalculates LMPs and MCPs of the affected intervals.
- In the event the RT SCED application is unavailable or dispatchers are unable to Dispatch the system by approving new RT SCED cases, dispatch may go “OFF SCED”. During the “OFF SCED” period, dispatch will use the EMS system to manage ACE and manually control any transmission constraints. During the “OFF SCED” period, LMPs will be calculated using the last valid approved RT SCED case prior to the start of the “OFF SCED” period. Should the “OFF SCED” period extend beyond two full hours, the LMPs may be further modified to reflect system conditions. Additionally, LPC cases may be adjusted to reflect system conditions in LMPs and MCPs, including but not limited to Reserve Shortage, Voltage Reduction and Manual Load Dump actions during “OFF SCED” periods.

2.11 Price-Bounding Violations

After each five (5) minute iteration of the LPC, a set of validation checks are applied to the resulting LMPs and ancillary service clearing prices. These validation checks include but are not limited to criteria such as maximum and minimum LMP level, maximum and minimum ancillary service clearing price level, and the consistency of the pricing results with the dispatch solution. If any of these validation checks fail, the five (5) minute LMPs and/or ancillary service clearing prices will continue to be published, however the solution for the given interval will be denoted as a Price-Bounding Violation interval.

The occurrence of a Price-Bounding Violation does not mean that the originally posted prices are not correct or that they are not used in the settlement of the market. It is an automated process implemented by PJM to notify the publication of market clearing prices are suspected to have an issue. If a Price-Bounding Violation occurs, PJM Market Operations personnel are notified by the LPC system immediately. Following the notification, the Market Operator will diagnose the cause of the violation. If the solution is found to be accurate, the five (5) minute prices are left as-is and the validation checks are adjusted to release subsequent pricing information. If the prices are found to be inaccurate, they are revised in accordance with the PJM Real-time Locational Marginal Price Verification Procedure as described in Section 2.10 of this Manual.

2.12 Calculation of Ramp Limited Desired MWh

Operating Reserve deviations to generators that are operating at PJM’s direction are based on a comparison of their Real-time desired MW with their Real-time MWh for each Real-time Settlement Interval. For the purposes of settlement of Operating Reserve charges and credits, a Ramp-Limited Desired MW value is used to determine whether a unit is following PJM dispatch instructions as well as the actual quantity of deviations that will be calculated when a unit is determined to not be following dispatch instructions.

PJM calculates a Ramp Limited Desired MW value for units where the economic minimum and economic maximum are at least as far apart in Real-time as they are in Day-ahead.

- Real-time Economic Minimum \leq 105% of Day-ahead Economic Minimum or Day-ahead Economic Minimum plus 5MW, whichever is greater.
- Real-time Economic Maximum \geq 95% of Day-ahead Economic Maximum or Day-ahead Economic Maximum minus 5MW, whichever is lower.

PJM determines a unit's Ramp Limited Desired MW according to the following calculation:

$$Ramp_Request_t = (Dispatch_{target_{t-1}} - AOutput_{t-1}) / (LAtime_{t-1})$$

$$RL_Desired_t = AOutput_{t-1} + (Ramp_Request_t * Case_Eff_time_{t-1})$$

Where:

Dispatch_{target}	Dispatch Signal for the previous approved Dispatch case
AOutput	Unit's achievable target MW at case solution time
LAtime	Dispatch look ahead time
Case_Eff_time	Time between signal changes
RL_Desired	Ramp Limited Desired MW

The Dispatch Signal LMP Desired MWh is calculated by comparing the five (5) minute Dispatch Signal LMP to the unit's bid curve to determine a corresponding MW value. This value is not ramp-limited.

In the event of technical difficulties where either a) the Dispatch Signal data does not exist or b) there is not a sufficient amount of data to calculate a reasonable Ramp Limited Desired MW value, the Dispatch Signal LMP Desired MW value is used.

See Section 5.1 "Operating Reserve Accounting Overview" of PJM Manual 28: Operating Agreement Accounting for a detailed description of the calculation of generator deviation charges.

2.13 Section Retired

2.14 Balancing Operating Reserve Cost Analysis

See Section 5.1 “Operating Reserve Accounting Overview” of PJM Manual 28: Operating Agreement Accounting for a detailed description of Operating Reserve accounting and awarded credits.

The offered price for pool-scheduled resources will be capped for the entire Operating Day in the event either of the following conditions exist:

- The generation resource is identified in the Day-ahead schedule to be dispatched out of economic merit order to control an identified transmission constraint.
- The generation resource is dispatched to provide quick start reserve for reliability.

In the event one of the above conditions exists, the offer prices will be capped at one of the following three levels, as specified in advance by the resource owner:

- The weighted average Real-time Locational Marginal Price at the generation bus during all hours over the past six (6) months in which the resource was dispatched in economic merit order above minimum.
- The incremental operating cost of the generation resource as determined by PJM Manual 15: Cost Development Guidelines plus the lesser of a 10% adder or \$100.
- An amount negotiated between PJM and the Market Seller in the event the generation resource cannot recover costs with either of the first two methods above.

In order to determine the reason why the Operating Reserve credit has been earned so that the charges related can be properly allocated, PJM conducts a Balancing Operating Reserve Cost Analysis (BORCA).

The purpose of the BORCA is to separate those Balancing Operating Reserve charges to be allocated to deviations between Day-ahead schedules and Real-time quantities from those that should be allocated to Real-time load and exports. The key factor in separating the allocation is the determination of the particular units by which Balancing Operating Reserve Credits were earned, and the units for which those credits should be allocated to deviations as opposed to those units for which those credits should be allocated to load and exports. This cost determination will occur in two stages: those units called on during the Reliability Analysis, and those units called on to operate during the Operating Day. In both cases, the following criteria is applied to such units to determine the reason Balancing Operating Reserve credits were earned.

For resources scheduled by PJM during its Reliability Analysis for an Operating Day, the associated Balancing Operating Reserve charges are allocated based on the reason the resource was scheduled.

- If the resource is committed to operate in Real-time to augment the physical resources committed in the Day-ahead Energy Market to meet the forecasted Real-time load plus the Operating Reserve Requirement, then in such cases, Balancing Operating Reserve charges will be allocated to Real-time deviations from Day-ahead schedules.
- If however, a resource is scheduled by PJM during its Reliability Analysis not to account for anticipated deviations between Day-ahead schedules and Real-time conditions but instead to provide additional reliability margin, Balancing Operating Reserve charges must be allocated to Real-time load plus exports.

For resources called on by PJM to operate during the Operating Day, the associated Balancing Operating Reserve charges are allocated based on the reason the resource was scheduled.

- Balancing Operating Reserve credits earned by units called on by PJM to operate during the Operating Day for which the LMP at the unit's bus does not meet or exceed the unit's applicable offer (cost or price) for at least four (4), five (5) minute intervals of at least one clock hour during which the unit was running at PJM's direction will be allocated according to ratio share of load plus exports.
- Balancing Operating Reserve credits earned by all other units operating at PJM's direction in Real-time will be allocated according to deviations between Day-ahead schedules and Real-time quantities. The logic behind this distinction is that units called on in Real-time for which LMP exceeds their offer for a significant number of intervals while they are running are necessary to meet load requirements respecting active transmission constraints.
- Units called on at PJM's direction in Real-time for which the LMP does not exceed the unit's offer were not needed and were therefore operating in order to ensure reliability is maintained as opposed to account for differences between Day-ahead schedules and Real-time system conditions.
- PJM further collects Balancing Operating Reserve credits that are accrued to resources operating to manage local transmission constraints. In order to appropriately collect the costs of Balancing Operating Reserve for local constraints within the pre-determined regions where the constraints existed, PJM calculates Regional Balancing Operating Reserve adders.
- PJM calculates Regional Balancing Operating Reserve adders for the following Regions within the PJM RTO.
 - Western Region of the PJM RTO, comprised of the AEP, APS, ATSI, ComEd, Duquesne, Dayton, DEOK, EKPC, and OVEC Zones.
 - Eastern Region of the PJM RTO comprised of the AEC, BGE, Delmarva, Dominion, PENELEC, PEPCO, ME, PPL, JCPL, PECO, DPL, PSEG and RE Zones.
- Generation resources with market based offers greater than \$1,000/MWh in the Day-ahead and Real-time Energy Market that are also greater than the resource's lowest available and applicable cost-based offer are not eligible to receive Balancing Operating Reserve Credits.

Balancing Operating Reserve credits that are accrued to resources operating to control transmission constraints that benefit the entire RTO are charged as an RTO Balancing Operating Reserve rate. See “Operating Reserve Accounting” section of PJM Manual 28: Operating Agreement Accounting for a detailed description of the calculation of allocation charges.

2.15 Maximum Emergency Generation in Day-ahead Market

If a Day-ahead demand bid MW cannot be satisfied with all available generation at its economic maximum MW limit, the Market Clearing Engine (MCE) shall issue a Maximum Generation Warning message due to a shortage of economic generation in the Day-ahead Market. The MCE shall then perform the following steps to achieve power balance:

Step 1: Increase all online generation up to its maximum emergency MW limit. Increase generator MW proportionately by ratio of economic maximum, if power balance is achieved prior to reaching maximum limits. Set LMP values equal to the highest offer of all online generation.

Step 2: If generation is still not enough to achieve power balance after Step 1, load offline generation that is designated as available only for maximum generation emergency conditions, as required. The order of loading is based on economic offer data. Set LMP values equal to the highest offer of all online generation.

Step 3: If generation is still not enough to achieve power balance after Step 2, drop any remaining price-sensitive demand to zero MW. Set LMP values equal to the highest price-sensitive demand bid that was cut in this step. If no price-sensitive demand was reduced in this step, the LMP values are set equal to highest offer price of all online generation resulting from Step 2.

Step 4: If power balance is not achieved after Step 3, reduce all load proportionately (by ratio of load MW) until balance is achieved. Set LMP values equal to the highest offer price of all online generation, the price from Step 3, or the bid cap (presently \$2,000/MWh), whichever is higher.

2.16 Minimum Capacity Emergency in Day-ahead Market

If the Day-ahead demand bid MW is less than the total generation MW with all possible generation off and with all remaining generation at their economic minimum MW limit, the MCE shall issue a Minimum Generation Warning message due to an excess of economic generation in the Day-ahead Market. The MCE shall then perform the following steps to achieve power balance.

Step 1: Reduce all online generation down to its minimum emergency MW limit. Reduce generator MW proportionately, by ratio of economic minimum, if power balance is achieved prior to reaching minimum limits. Set LMP values equal to the lower of zero or to the lowest offer price of all online generation.

Step 2: If power balance is not achieved after Step 1, set LMP values to zero. Reduce all online generation below emergency minimum proportionately by ratio of emergency minimum to achieve power balance.

2.17 Applying Transmission Constraint Penalty Factors in the Market Clearing Engine

Transmission constraint penalty factors are parameters used by the Market Clearing Engine (MCE) to specify the maximum cost willing to be incurred to control a transmission constraint. The ultimate effect of the transmission constraint penalty factor is that it limits the controlling actions the MCE can take to resolve a constraint by limiting the cost that is willing to be incurred to control it.

The objective of the constraint control logic is to dispatch the least cost set of resources to meet the target facility limit that dispatch is trying to control the constraint to at a marginal cost at or below the transmission constraint penalty factor. The transmission constraint penalty factor does not directly impact the marginal value of a constraint as long as the constraint can be solved by resources whose effective costs are lower than the value of the penalty factor. The cost of using a resource to control a constraint, or its effective cost, can be approximated by using the following equation.

$$\text{Effective Cost} \left(\frac{\$}{\text{MWh}} \right) = \left| \frac{(\text{Energy Price} + \text{Loss Price} + \text{Congestion Price (all binding constraints)} - \text{Incremental Cost})}{D_{\text{fax}}} \right|$$

If the flow on the constraint cannot be controlled below the level to which dispatch is attempting to control the facility it results in a constraint violation in the MCE optimization. The transmission constraint penalty factor is then used to set the marginal value of the violated transmission constraint.

PJM internal constraints including Market-to-Market coordinated constraints, regardless of voltage level, are defaulted to a \$30,000/MWh transmission constraint penalty factor in the Day-ahead MCE when determining the Day-ahead security constrained economic dispatch, known as the dispatch run, and \$2,000/MWh in the determination of Day-ahead Prices in the pricing run.

All PJM internal constraints, regardless of voltage level, are defaulted to a \$2,000/MWh transmission penalty factor in the Real-time Energy Market. PJM may adjust the default penalty factor in Real-time for Market-to-Market coordinated constraints to reflect the operating practices which are mutually agreed upon with the neighboring RTO/ISO for managing such constraints. In Real-time, the transmission constraint penalty factor value for an individual constraint is utilized in both the dispatch and pricing runs.

PJM can also adjust, for an individual constraint, the default penalty factor or temporarily change the default penalty factor for an individual constraint, in order to reflect system operational needs and the cost of the resources available to effectively relieve congestion on the constraint. PJM may also adjust the default Transmission Constraint Penalty Factor in either the Day-ahead or Real-time Energy Market if the constraint is caused by a transmission outage associated with a Regional Transmission Expansion Plan (RTEP) or a planned transmission upgrade necessitated by interconnection request(s) in the impacted area designed to improve system reliability.

When PJM identifies that the cost of controlling actions are not being properly reflected in pricing, the transmission constraint penalty factor will be increased or decreased as explained in the examples detailed below. Once it has been identified that an adjustment is required, PJM dispatchers and Real-time Markets support engineers make real-time evaluations of the appropriate transmission constraint penalty factor adjustments based on an effective resource's cost to control a constraint (expressed in \$/MW as defined below):

$$\frac{\$}{MW} = \frac{(\text{Resource Offer Price} - \text{System Energy Price})}{dfax}$$

When not enough relief can be provided by resources at a cost below the default transmission constraint penalty factor, PJM retains the ability to increase the transmission constraint penalty factor (or willingness to pay for control) for a constraint when congestion flow is over or approaching the controlled limit and additional available resources have a \$/MW cost above the default transmission constraint penalty factor. Conditions requiring increasing the transmission constraint penalty factor for a constraint include, but are not limited to:

1. An effective resource with a raise-help *dfax* is required, but the system energy price has decreased such that the resource's \$/MW cost exceeds the default transmission constraint penalty factor.
2. An effective resource with a lower-help *dfax* is required, but the system energy price has increased such that the resource's \$/MW cost exceeds the default transmission constraint penalty factor.
3. Additional relief for a constraint is required from a resource with a \$/MW cost above the default transmission constraint penalty factor based on the resource's Offer Price and/or *dfax*.

When the congestion flow is within the controlled limit, PJM also retains the ability to lower the transmission constraint penalty factor for a constraint in order to prevent a high cost resource that cannot provide material relief on the constraint from inappropriately setting price. Conditions requiring lowering the shadow price limit for a constraint include, but are not limited to:

1. A thermal surrogate is used to set price for a resource called for voltage control and the resource's \$/MW is lower than the default transmission constraint penalty factor.
2. A constraint with many low *dfax*, high cost resources where the available control is sufficient and over controlling the constraint by allowing ineffective resources to artificially raise the price would result in ACE deviations and/or other system controlling issues.

3. A constraint caused by a transmission outage associated with a Regional Transmission Expansion Plan (RTEP) or planned transmission upgrade by interconnection request(s) in the impacted area designated to improve system reliability.

PJM incorporates a buffer typically of 25% above the effective resource's \$/MW cost when setting the adjusted marginal value limit. This buffer accounts for any fluctuation in the system energy price that would increase a resource's \$/MW cost.

2.18 Applying Stability Limits in the Market Clearing Engine

The ability of a generating unit or a group of generating units to maintain synchronism following a system disturbance can be identified using real time and study applications such as the PJM Transient Stability Analysis (TSA) tool. Based on results from TSA, stability limits will be established and logged within PJM's TO Connection. For real power (MW) stability limits only, TO Connection stability limits will be translated into a corresponding generator output constraint (in MW) for a single generator or a group of generators.

If the system disturbance is identified and the applicable stability limit is known prior to the Day-ahead Market closure, it will be included in the Day-ahead Market Clearing Engine. The generator output constraint will limit the sum of the dispatched MW (including ancillary services) of the affected generating unit(s) while dispatching them in economic merit order up to the stated limit. Similar to other operational constraints (e.g. ramp rate limitations) the shadow price of the generator output constraint will not be included in the LMP. Any generating unit or group of generating units that is reduced using a generator output constraint is not eligible for lost opportunity cost credits for the MW reduction associated with honoring the stability limit.

PJM will communicate on a periodic basis statistics on the frequency, location and number of affected generating units to the extent it is consistent with PJM confidentiality rules.

Additional details regarding stability limits may be found in Manual 3, Section 3.9.1, Manual 12, Section 5.5 and Manual 28, Section 5.2.6.

2.18.1 Treatment of non-Real MW Stability Limits

Per Manual 3, Section 3.9.1, there are a total three types of stability limits: real power, reactive power and station. The Market Clearing Engines will not consider either the reactive power or station stability limits. However, if a generating unit or a group of generating units are being reduced for a station stability limit, it will not be eligible for lost opportunity cost credits for the MW reduction associated with honoring the stability limit.

2.19 Notification of a Performance Assessment Interval

The initial notification of a Performance Assessment Interval (PAI) will be based on a Primary Reserve Shortage condition from the dispatch run solution. Condition 1 and/or condition 2, as

described in section 8.4A of Manual 18, must be effective for the target time of the interval to designate the interval for potential performance assessment. If such conditions are met, the indicator will be communicated for resource owners capable of receiving the data point via ICCP or DNP3 protocols data transfer, upon approval of the Real-Time Security Constrained Economic Dispatch (RTSCED) case. Additionally, the PAI indicator can be found in PJM's Data Miner 2 tool. The initial PAI notification is based on the best information available in real-time. Final determination of whether an interval triggers a Performance Assessment Interval will be in accordance with Section 8.4A of Manual 18.

2.20 Interface Prices

Interface Pricing Points are a grouping of individual busses combined into a proxy-pricing node (pnode) utilized for purposes of calculating LMPs for energy exports to or energy imports from external balancing authority areas. Such Interface Pricing Points may represent external balancing authority areas, aggregates of external balancing authority areas, or portions of any external balancing authority area.

A review of Interface Pricing Point definitions for purposes of calculating LMPs for energy exports to or energy imports from external balancing authority areas is conducted on an annual basis. The review is based on a set of flow impact analyses utilizing power flow analysis tools for each Interface Pricing Point. The scope of the annual review of Interface Pricing Points includes the MISO, NYIS and SOUTH interfaces. Results of the annual review will be posted to the PJM website no later than February 28 of each calendar year.

Section 3: Overview of the PJM Regulation Market

Welcome to the Overview of the PJM Regulation Market section of the PJM Manual for Energy & Ancillary Services Market Operations. In this section you will find the following information:

- An overview description of the PJM Regulation Market (see “Overview of PJM Regulation Market”).
- A list of the PJM Regulation Market Business Rules (see “PJM Regulation Market Business Rules”).

3.1 Overview of the PJM Regulation Market

The PJM Regulation Market provides PJM participants with a market-based system for the purchase and sale of the Regulation ancillary service. Resource owners submit specific offers for Regulation Capability and Regulation Performance, and PJM utilizes these offers together with energy offers and resource schedules from the Markets Gateway System as input data to the Ancillary Service Optimizer (ASO) which is an hour-ahead Market Clearing Engine. ASO optimizes the RTO dispatch profile and forecasts LMPs to determine hourly commitments of Regulation to meet the requirement.

The Real-time Security Constrained Economic Dispatch (RT SCED) program jointly optimizes Energy and Reserves subject to transmission constraints, Reserve Requirements and prior committed Regulation. For more information on how RT SCED uses Regulation commitments in the joint optimization, please refer to Section 2.5 of this Manual. The five (5) minute Regulation Market Clearing Price (RMCP) and Regulation Market Performance Clearing Price (RMPCP), are calculated by the Locational Price Calculator as described in Section 2.7 of this Manual and are used to derive the five (5) minute Regulation Market Capability Clearing Price (RMCCP). These clearing prices are then used in market settlements to determine the credits awarded to providers and charges allocated to purchasers of the Regulation service.

PJM uses resource schedules, regulation offers, and energy offers from the Markets Gateway System as input data to the ASO to provide the lowest cost alternative for the procurement of Regulation for each hour of the operating day. The lowest cost alternative for this service is achieved through a simultaneous co-optimization with Synchronized Reserves, Non-Synchronized Reserves, Secondary Reserves and Energy. Within the co-optimization, an RTO dispatch profile is forecasted along with LMPs for the market hour.

Using the dispatch profile and forecasted LMPs, an opportunity cost, adjusted by the applicable Performance Score and Benefits Factor, is estimated for each resource that is eligible to provide Regulation. The estimated opportunity cost for Demand Resources is zero. The adjusted lost opportunity cost is added to the adjusted regulation capability cost and the adjusted regulation performance cost to make the adjusted total regulation offer cost. The adjusted total regulation offer cost is then used to create the merit order price.

Resource owners may self-schedule Regulation on any qualified resource. The merit order price for any self-scheduled Regulation resource is zero. All available regulating resources are then ranked in ascending order of their merit order prices, and the lowest cost set of resources necessary to simultaneously meet the PJM Regulation Requirement, PJM Synchronized Reserve Requirement, PJM Primary Reserve Requirement, and PJM 30-minute Reserve Requirement and provide Energy in that hour is determined. If there is an excess of self-scheduled and zero-cost offers over and beyond the Regulation Requirement, PJM uses resource-specific historic performance scores, selecting those resources with the highest performance scores, as a tie-breaker to determine which set of resources to commit to meet the Regulation Requirement. The least cost set of Regulation resources identified through this process are then committed.

Prices for Regulation are calculated simultaneously with Energy and Reserves every five (5) minutes by the Locational Pricing Calculator (LPC) in the pricing run. The highest merit order price associated with this lowest cost set of resources awarded Regulation becomes the RMCP. The RMPCP is calculated as the highest adjusted performance offer from the set of cleared resources. The RMCCP is the difference between RMCP and RMPCP.

In the after-the-fact settlement, any resources self-scheduled to provide Regulation are compensated based on the processes described in PJM Manual 28: Operating Agreement Accounting.

3.2 PJM Regulation Market Business Rules

3.2.1 Regulation Market Eligibility

Regulation offers may be submitted only for those resources electrically within the PJM RTO.

To regulate, a resource must meet the following criteria:

- Generation resources as well as Demand Resources must be able to provide 0.1 MW of Regulation Capability in order to participate in the Regulation Market. Generation resources must have a governor capable of automatic generation control (AGC).
- Generation and Demand Resources must be able to receive and respond to an AGC signal. A resource's MW output must be telemetered to the PJM control center in a manner determined to be acceptable by PJM.
- New resources must pass an initial performance test (minimum 75% compliance required).
- Resources must demonstrate minimum performance standards, as set forth in PJM Manual 12: Balancing Operations, Section 4: Providing Ancillary Services.
- Resources should give priority to the regulation signal by not allowing the sum of the regulating ramp rate and energy ramp rate to exceed the economic ramp rate. Only after a regulating resource has accounted for the regulation capability, may a generator use net of the Dispatch Signal and the regulation ramp rate to follow the energy signal.

- Demand Resources must complete initial and continuing training on the Regulation Market as documented in PJM Manual 40: Certification and Training Requirements, Section 3.2.5: Training Requirements for Demand Response Resources.
- When a Demand Resource that is eligible for the Regulation Market is called for a mandatory Emergency or Pre-Emergency Load Management Event, it is de-assigned from Regulation for any intervals that overlap with the Load Management Event, starting from the notice time of the Load Management Event, unless otherwise approved by PJM. PJM will not assign the resource to Regulation for the remainder of the mandatory portion of the Load Management Event.

The following information must be supplied through the Markets Gateway System:

- Resource Regulating Status (available, unavailable, self-scheduled)
- Regulation Capability (above and below regulation midpoint, MW)
- Regulation Maximum and Minimum values, considering any necessary offsets (MW)
- Demand Resources must submit valid Economic and Regulation Maximum and Minimum MW limits respectively
- Regulation Signal Type – RegA and/or RegD
- Cost-Based Regulation Offer (\$/MWh): This value is validated using the unit-specific operating parameters submitted with the regulation offer and the applicable \$12/MWh regulation margin adder. The portions of the cost based offer are split into:
 - Regulation Capability portion capturing the Fuel Cost Increase and Unit Specific Heat Rate Degradation due to Operating at Lower Loads. The margin adder may only be added to the Regulation Capability portion; and,
 - Regulation Performance portion representing Cost Increase due to Heat Rate Increase during non-steady state operation and Cost Increase in VOM.
 - The \$/MW value determined in this step is converted to \$/ΔMW by dividing the value by mileage ΔMW/MW for the applicable signal for that offer.
- Price-Based Regulation Offer (\$/MWh, optional): This value is capped at \$100/MWh, and its submission is optional on the part of the market participant. The portions of the price-based offer are split into:
 - Regulation Capability portion capturing the resource owner's price to reserve MWs for regulation in \$/MW; and,
 - Regulation Performance portion capturing the resource owner's price to provide regulation movement in \$/ΔMW.
 - The \$/MW value determined in this step is converted to \$/ΔMW by dividing the value by mileage ΔMW/MW for the applicable signal for that offer.

In addition to the cost-based regulation offer price, each market participant may also submit additional information to support the cost-based offer price. Using the calculations in PJM Manual 15: Cost Development Guidelines, PJM validates the cost-based regulation offer price

to ensure that it does not exceed actual regulating cost as determined by this Manual, plus the applicable regulation margin adder. Any cost-based offer prices that exceed this value are rejected by the Markets Gateway System. An example of this calculation is available on the PJM website in the 'Regulation Two Part Cost-Based Offer' document, located at <https://www.pjm.com/-/media/markets-ops/ancillary/regulation-two-part-cost-based-offer-effective-20181204.ashx?la=en>.

Regulation offer prices and MWs cannot be negative.

If a market participant does not submit a cost-based regulation offer price they are not permitted to participate in the PJM Regulation Market until such offer has been validated. Any participants that do not submit any of the supporting parameters below will have their cost-based regulation offer price capped at the margin adder of \$12/MWh.

The following optional parameters may be submitted in the Markets Gateway System to support the cost-based regulation offer price. If any of these parameters are not submitted they are defaulted to zero.

- Heat Rate @ EcoMax [BTU/kWh]: The heat rate at the default economic maximum for a resource. The economic maximum that corresponds to this rate value is the default economic maximum shown on both the Daily Regulation Offers and Unit Details pages.
- Heat Rate @ RegMin [BTU/kWh]: The heat rate at the default regulation minimum for a resource. The regulation minimum that corresponds to this rate value is the default regulation minimum shown on both the Daily Regulation Offers and Unit Details pages.
- VOM Rate [\$/MWh of Regulation]: The increase in VOM resulting from operating the regulating resource at a higher heat rate than is otherwise economic for the purpose of providing regulation.
- Fuel Cost [\$/MBTU]: The fixed fuel costs of the resource. This value is used to determine the heat rate adjustments during steady-state and non-steady-state operation for the purpose of providing regulation.

Regulation resources that are dual certified as RegA and RegD may submit a set of offers for each signal type. In such case, the Market Clearing Engine evaluates both offers but will clear the resource for either one or neither of the two signal types based on economics and system needs. A dual certified resource offering both signal types in a given hour, if cleared for Regulation, is assigned one signal type for that the entire hour. The signal type assigned may vary from one hour to another during the course of the day if both signal types are made available consistently.

- If a dual certified resource submits self-scheduled regulation offers as both RegA and RegD signal types in the same hour, the Market Clearing Engine only evaluates the RegA self-schedule offer and then either commits the resource or not based on system needs.
- If a resource submits offers into both the Regulation and Reserve Markets in the same hour, the regulation offer receives higher priority in the market clearing process, meaning if economic for both markets, the unit is committed for Regulation rather than Reserves.

3.2.2 Regulation Market Data Timeline

Daily Cost-based and Price-based Regulation Offer(s) and any applicable cost information must be supplied prior to 14:15 the day prior to the Operating Day. To accurately reflect each resource's capability and availability during the Operating Day, the following information may be submitted on an hourly basis and/or changed up until sixty-five (65) minutes prior to the start of the operating hour, at which time the Regulation Market closes.

- Resource Regulating Status.
- Regulation Capability.
- Regulation Maximum and Regulation Minimum.

Market Participants who did not elect to opt-out of Intraday Updates as detailed in Section 9.1.1 of this Manual may also submit and/or change:

- Regulation Capability Offer (\$/MWh).
- Regulation Performance Offer (\$/MWh).

Daily Regulation Offers submitted for a capacity resource on the Regulation Offers page in Markets Gateway are automatically carried over from one day to the next unless updated. Changes made on the Regulation Updates pages of Markets Gateway are not carried over into the next day. Any changes made to the Regulation Updates pages supersede the values on the Offers page. The Real-time Market Clearing Engines will use the offered in parameters as detailed in Sections 2.5 and 2.7 of this Manual.

In the event that the Regulation Maximum and Regulation Minimum limits are not the most restrictive for a given resource (i.e. the Regulation Maximum is not the lowest of all the high limits and the Regulation Minimum is not the highest of all the low limits), the ASO will utilize the most restrictive minimum and maximum of all applicable limits for real time.

- Should a resource wish not to participate in the Regulation Market in any given hour on the Operating Day, the following update should be made at least sixty-five (65) minutes prior to the operating hour in the Regulation Updates page of the Markets Gateway System:
 - Set Offer MW to zero and
 - Set Available status to Not Available.
- Should a resource's regulation operating parameters change after the Regulation Market closes for an hour, the following changes may be made through direct communication with the PJM Master Coordinator:
 - Resource Regulating Status:
 - Available to unavailable.
 - Self-scheduled to unavailable.
 - High Regulation Limit may be decreased but not increased and Low Regulation Limit may be increased but not decreased.
 - Regulating Capability may be decreased but not increased.

- Regulation Maximum Capability may be decreased but not increased and Regulation Minimum Capability may be increased but not decreased.

3.2.3 Regulation Bilateral Transactions

Regulation Bilateral Transactions may be reported to PJM. Such reported Regulation Bilateral Transactions must be for the physical transfer of Regulation and must be reported by the buyer and subsequently confirmed by the seller through the Markets Gateway System no later than 13:30 the day after the transaction starts. Bilateral transactions that have been reported and confirmed may not be changed; they must be deleted and re-reported. Deletion of a reported bilateral transaction is interpreted as a change in the end time of the transaction to the current hour, unless the transaction has not yet started.

The buyer on the transaction submits the MW amount, the seller, and the start and end time of the transaction via the Markets Gateway System. The seller confirms the transaction via the Markets Gateway System by 13:30 the day after the start date of the bilateral transaction.

Payments and related charges associated with the Regulation Bilateral Transactions reported to PJM shall be arranged between the parties to the bilateral contract.

A buyer under a bilateral regulation contract reported to PJM agrees that it guarantees and indemnifies PJM, PJM Settlement, and the market participants for the costs of any purchases by the seller in the Regulation Market, as determined by PJM, to supply the reported bilateral transaction and for which payment is not made to PJM Settlement by the seller.

Upon any default in obligations to PJM or PJM Settlement by a Market Participant, PJM shall not accept any new bilateral reporting by the Market Participant and shall terminate all of the Market Participant's reporting of Markets Gateway schedules associated with its Regulation Bilateral Transactions previously reported to PJM for all days where delivery had not yet occurred.

PJM calculates and posts Regulation Zone preliminary billing data on which market participants can use as a resource for pricing Regulation Bilateral Transactions. The data can be found in PJM's Data Miner 2 tool: http://dataminer2.pjm.com/feed/ancillary_services_fivemin_hrl.

3.2.4 Regulation Requirement Determination

The total PJM Regulation Requirement for the PJM RTO is determined in whole MW for the ramp and non-ramp periods. Demand Resources are limited to providing 25% of the regulation requirement. Further details can be found in PJM Manual 12: Balancing Operations, Section 4.3.3 Determining Regulation Assignment.

3.2.5 Regulation Obligation

Hourly participant Regulation Obligations are determined after-the-fact, based on the LSE's actual load ratios. Participants can estimate their share of the PJM Regulation Requirement in

advance by comparing their hourly load forecast to the PJM hourly load forecasts provided by PJM.

LSEs may fulfill their Regulation Obligations by:

- Self-scheduling the entity's own resources;
- Entering contractual arrangements with other Market Participants; or
- Purchasing Regulation from the Regulation Market.

3.2.6 Regulation Offer Period

Resource owners wishing to participate in the Regulation Market must at least supply a daily cost-based Regulation Offer reflecting both Regulation Capability Offer Cost and the Regulation Performance Cost of the resource by 14:15 the day prior to the Operating Day, and the remainder of the necessary data prior to the Regulation Market closing as stated above in Section 3.2.2 of this Manual.

Daily Regulation Offers are locked as of 14:15 the day prior to the Operating Day. The markets database is generally unavailable for updates to offers for the next Operating Day between 11:00 and the time PJM posts the results of the Day-ahead Energy Market for that Operating Day while the Day-ahead Market is being cleared. Hourly updates to Regulation Offers, as defined in Section 3.2.2 of this Manual, can be submitted up to sixty-five (65) minutes prior to the start of the operating hour. All resources listed as available for Regulation with no offer price have their offer prices set to zero.

3.2.7 Regulation Market Clearing

PJM clears the Regulation Market taking into account forecast load, transmission constraints and reserve requirements and posts the results no later than thirty (30) minutes prior to the start of the operating hour in the Markets Gateway System.

3.2.7.1 Dispatch in the Regulation Market

Economic ramp rate must be adjusted when resources provide Regulation to minimize the conflict between Energy and Regulation services. The segment specific ramp rates should be calculated from the economic ramp rate as follows:

$$\text{Reduced Energy Ramp Rate} = \max \left(0, \text{Economic Ramp Rate} - \frac{\text{Cleared Regulation Capacity (AREG)}}{5 \text{ Minutes}} \right)$$

To increase consistency in the Individual Generator Dispatch (IGD) set point sent by PJM while a unit is regulating, the IGD set point will only move up when the RT-SCED LMP justifies raising the resource and the resource has a non-zero reduced energy ramp rate. The IGD set point will only move down when the RT-SCED LMP justifies lowering the resource and the resource has a non-zero reduced energy ramp rate. The reduced energy ramp rate is a member-entered, unit-specific percentage of the bid-in energy ramp rate for each resource. If no value is entered in the Market Gateway system for the resource, a default of zero is used.

3.2.7.2 Regulating Capability Cost

For each resource, PJM calculates an adjusted Capability Cost, as

$$\text{Adjusted Regulating Capability Cost (\$)} = \frac{\left(\begin{array}{c} \text{Capability} \\ \text{Offer (\$ / MW)} \end{array} \right)}{\left(\begin{array}{c} \text{Benefits Factor} \\ \text{of} \\ \text{Offered Resource} \end{array} \right)} * \frac{\left(\begin{array}{c} \text{Capability} \\ \text{(MW)} \end{array} \right)}{\left(\begin{array}{c} \text{Historic} \\ \text{Performance} \\ \text{Score} \end{array} \right)}$$

The Adjusted Regulating Capability Offer is adjusted by the Benefits Factor of the specific offered resource and the historic performance score of the resource. The Benefits Factor is defined later in Section 3.2.7.6 of this Manual. The historic performance score is discussed in PJM Manual 12: Balancing Operations, Section 4.4.5 Disqualification and Requalification of a Resource.

3.2.7.3 Mileage and the Performance Offer

Mileage is the summation of movement requested by the regulation control signal a resource is following. It is calculated for the duration of the market hour for each regulation control signal (i.e. RegA and RegD).

$$\text{Mileage}_{\text{RegA}} = \sum_{i=1}^n | \text{RegA}_i - \text{RegA}_{i-1} |$$

$$\text{Mileage}_{\text{RegD}} = \sum_{i=1}^n | \text{RegD}_i - \text{RegD}_{i-1} |$$

PJM calculates the performance-adjusted Performance Cost, as

$$\text{Adjusted Performance Cost (\$)} = \frac{\left(\begin{array}{c} \text{Performance} \\ \text{Offer (\$ / } \Delta \text{ MW)} \end{array} \right) * \left(\begin{array}{c} \text{Mileage} \\ \text{of} \\ \text{Offered Resource} \\ \text{Signal Type (} \Delta \text{ MW / MW)} \end{array} \right)}{\left(\begin{array}{c} \text{Benefits Factor} \\ \text{of} \\ \text{Offered Resource} \end{array} \right) * \left(\begin{array}{c} \text{Historic} \\ \text{Performance} \\ \text{Score} \end{array} \right)} * \left(\begin{array}{c} \text{Capability} \\ \text{(MW)} \end{array} \right)$$

Similar to the Adjusted Regulating Capability Offer, the Adjusted Performance Offer is adjusted by the Benefits Factor of the specific offered resource and the historic performance score of the resource. The Benefits Factor is defined later in Section 3.2.7.6 of this Manual. The historic performance score is discussed in PJM Manual 12: Balancing Operations, Section 4.4.5 Disqualification and Requalification of a Resource. The performance offer is priced on a \$ per change in MW, to normalize the performance between signal types. The historical mileage is a rolling 30-day average by the signal type that the resource has qualified to follow.

3.2.7.4 Lost Opportunity Cost (LOC)

Estimated resource opportunity cost is calculated as follows:

- Each MCE, as described in Section 2.5 of this Manual, utilizes the lesser of the available price-based energy schedule or most expensive available cost-based energy schedule (the “lost opportunity cost energy schedule”), and forecasted LMPs to determine the estimated opportunity cost each resource would incur if it adjusted its output as necessary to provide its full amount of regulation.

The approximate formula for the lost opportunity cost incurred during the regulating hour used by the MCE for commitment, based on the dispatch run, is:

$$| LMP - ED | * GENOFF$$

Where:

LMP	is the forecasted hourly LMP at the resource bus,
ED	is the price from the lost opportunity cost energy schedule associated with the set-point the resource must maintain to provide its full amount of regulation, and
GENOFF	is the MW deviation between economic dispatch and the regulation set-point.

The approximate formula for the lost opportunity cost incurred during the regulating hour used for Regulation Pricing, based on the LPC pricing run, is:

$$| LMP - ED | * GENOFF$$

Where:

LMP	is the actual 5-minute LMP at the resource bus,
ED	is the price from the lost opportunity cost energy schedule associated with the set-point the resource must maintain to provide its full amount of regulation, and
GENOFF	is the MW deviation between economic dispatch and the regulation set-point.

All unit-specific lost opportunity costs are divided by the Benefits Factor of the specific offered resource and the resource's historic performance score for the purposes of commitment and setting the Regulation Market Clearing Prices. The Benefits Factor is defined later in Section 3.2.7.6 of this Manual. The historic performance score is discussed in PJM Manual 12: Balancing Operations, Section 4.4.5: Disqualification and Requalification of a Resource.

PJM calculates the Adjusted Lost Opportunity Cost as:

$$\text{Adjusted Lost Opportunity Cost (\$)} = \frac{\left(\frac{\text{Estimated Lost Opportunity}}{\left(\frac{\$}{\text{MW}} \right)} \right)}{\left(\begin{array}{c} \text{Benefits Factor} \\ \text{of} \\ \text{Offered Resource} \end{array} \right)} * \frac{\left(\begin{array}{c} \text{Capability} \\ (\text{MW}) \end{array} \right)}{\left(\begin{array}{c} \text{Historic} \\ \text{Performance} \\ \text{Score} \end{array} \right)}$$

Both lost opportunity cost calculations are defined simplistically for the purpose of the Manual. The actual calculations are integrations that may be visualized as the area on a graph enclosed by the lost opportunity cost energy schedule, the points on that curve corresponding to the resource's desired economic dispatch and the set-point necessary to provide the full amount of regulation, and the LMP. A sample calculation can be found on PJM website at <https://pjm.com/-/media/markets-ops/ancillary/regulation-uplift-and-lost-opportunity-cost.ashx?la=en>.

PJM may call on resources not otherwise assigned in order to provide Regulation, in accordance with PJM's obligation to minimize the total cost of Energy, Operating Reserves, Regulation, and other Ancillary Services. If a resource is called on by PJM for the purpose of providing Regulation, the resource is eligible for recovery of Regulation Lost Opportunity Costs as well as start-up, no-load, and energy costs.

Please refer to Section 4.2 of PJM Manual 28: Operating Agreement Accounting for additional details on how LOC is used in settlements.

Resources not eligible or with no lost opportunity associated with providing regulation:

- Energy resources that are self-scheduled to provide Energy and do not supply an Energy Offer.
- Demand Resources.
- Non-Energy Regulation-only resources.

Notwithstanding the above, resources that do not submit an energy offer curve will have a Lost Opportunity Cost of zero.

3.2.7.5 Total Offer

Each resource must be ranked based on the total expected cost of that resource regulating. PJM calculates the Adjusted Total Offer of the resource as follows:

$$Adjusted\ Total\ Offer\ Cost\ (\$) = \begin{pmatrix} Adjusted \\ Regulation \\ Capability \\ Cost \\ (\$) \end{pmatrix} + \begin{pmatrix} Adjusted \\ Lost \\ Opportunity \\ Cost \\ (\$) \end{pmatrix} + \begin{pmatrix} Adjusted \\ Performance \\ Cost \\ (\$) \end{pmatrix}$$

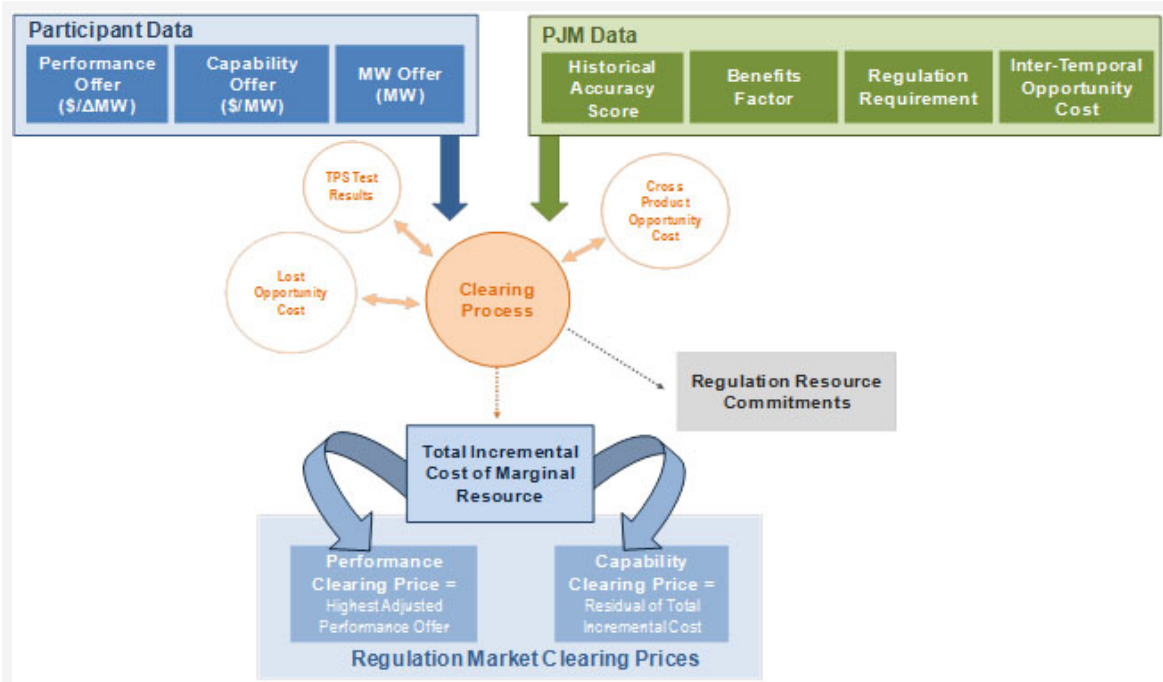

Each MCE, as described in Sections 2.5 and 2.7 of this Manual, ranks all available regulating resources in ascending merit order price, and simultaneously determines the least expensive set of resources necessary to provide Energy, Regulation and Reserves for the operating hour taking into account any resources self-scheduled to provide any of these services. The Rank Price is determined as follows:

$$\text{Rank Price} = \frac{\text{Adjusted Total Offer Cost (\$)}}{\text{Capability (MW)}}$$

Should the MCE be unable to fulfill both the Regulation and Reserve Requirements, Regulation receives the higher priority.

PJM clears the market to meet the Regulation Capability Requirement. The Regulation Capability Requirement sets the amount of regulating capability that PJM believes it would need to absorb sustained RTO ACE deviations adjusted by the Benefits Factor of a specific offered resource and the resource's historic performance score. The Benefits Factor is defined later in Section 3.2.7.6 of this Manual. The historic performance score is discussed in PJM Manual 12: Balancing Operations, Section 4.4.5: Disqualification and Requalification of a Resource. The market will assign resources until the constraint is met, by

Regulation Capability Requirement

$$MW \leq \sum_{i=0}^n \text{Capability (MW)}_{i*} * \text{Benefits Factor of Offered Resource}_i * \text{Historic Performance Score}_i$$

With the Regulation Capability constraint satisfied, the Rank Price (\$/MW) of the last assigned resource sets the Regulation Market Clearing Price (RMCP). This RMCP is used to derive the clearing price for the Regulation Capability and Regulation Performance components. First the Regulation Market Performance Clearing Price (RMPCP) is calculated by finding the maximum adjusted performance offer from the set of all cleared resources' adjusted performance offers as follows:

Regulation Market Performance Clearing Price (\$ / MW) =

$$\max_{\text{Assigned Resources}} \left(\frac{\left(\text{Performance Offer (\$/ } \Delta \text{ MW)} \right) * \left(\begin{array}{l} \text{Mileage of Offered Resource} \\ \text{Signal Type (} \Delta \text{ MW / MW)} \end{array} \right)}{\left(\begin{array}{l} \text{Benefits Factor of Offered Resource} \\ \text{Historic Performance Score} \end{array} \right)} \right)$$

Then the RMPCP is subtracted from the RMCP for the Regulation Market Capability Clearing Price (RMCCP), which is the residual between the RMCP and RMPCP.

$$\text{Regulation Market Capability Clearing Price (\$/MW)} = \\ (\text{Regulation Market Clearing Price (\$/MW)}) - (\text{Regulation Market Performance Clearing Price (\$/MW)})$$

The five (5) minute Regulation Clearing Prices, calculated using the pricing run of LPC, are posted in the Data Viewer user interface public view. RMCP(s) and other billing determinant information is also available via PJM's Data Miner 2 tool: http://dataminer2.pjm.com/feed/ancillary_services_fivemin_hrl.

If no Regulation Market Results are posted to the Markets Gateway System for an hour, PJM will continue the current assignments, as needed, into the un-posted hour. There will be no impact to the price calculation. The Regulation Clearing Prices continue to be calculated by LPC every five (5) minutes in Real-time and are used for settlement.

3.2.7.6 Benefits Factor Function

Regulating resources can follow either a RegA (traditional) or RegD (dynamic) signal based on their resources' limitation and business practices. The regulating resources cleared in any hour can be any set of or mix of both traditional and dynamic resources. There is an operational relationship between the regulating resource mix and how the Regulation Requirement is satisfied. This relationship is included in the market clearing process as the Benefits Factor Function because the relationship is depicted as a curve.

The Benefits Factor translates a dynamic resource's MWs into traditional MWs or Effective MWs. These Effective MWs reflect the rate of substitution between resources following the different regulation signals. For market clearing, each dynamic resource is assigned a decreasing and unique Benefits Factor. The Benefits Factor of the offered resource or resource specific Benefits Factor is the marginal point on the Benefits Factor Function that aligns with the last MW, adjusted by historical performance, that specific resource will add to the dynamic resource stack.

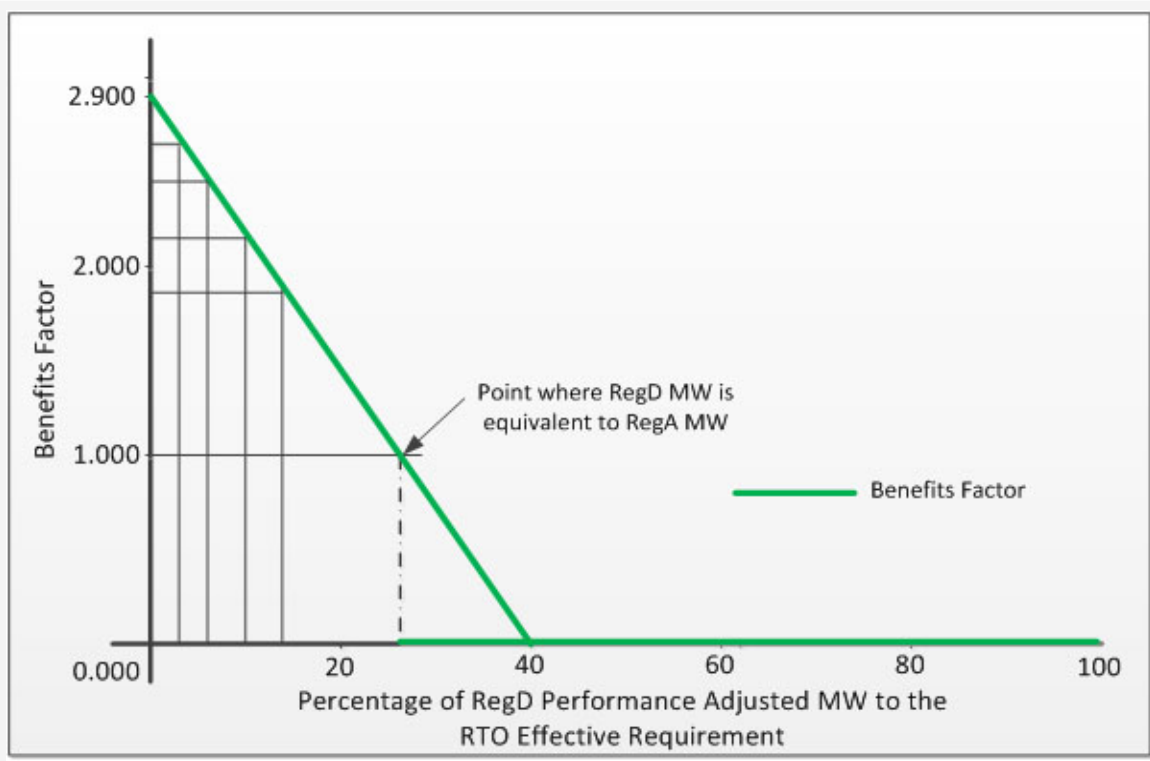

The Benefits Factor ranges from 2.9 to 0 where a Benefits Factor of 1 is equivalent to a traditional resource. PJM will review the Benefits Factor as operational conditions warrant to re-evaluate the relationship when needed. These operational conditions could include, among other factors, changes to the regulation signal tuning parameters, changes in the set of resources providing regulation service, and changes to the Regulation Requirement.

PJM determines the Benefits Factor based on the expected impact that dynamic resources have on the NERC reliability criteria. Determination of expected response is based on a combination of off-line models, analysis of the regulation signals, and the historical operational data as it accumulates. Historical operational data is given increasing weight to the Benefits Factor determination over time. Changes to the Benefits Factor Function are made periodically after review at the Operating Committee.

The net impact of the use of the Benefits Factor is to increase the likelihood of dynamic resources being selected in the clearing process, up to the point of diminishing returns. Beyond the point of diminishing returns (1 to 0), the Benefits Factor will decrease the likelihood of dynamic resources being cleared. RegD resources with a benefits factor less than 0.1 are not considered in the regulation clearing.

During identified hours where more sustaining regulation (RegA) and less dynamic regulation (RegD) is warranted, RegD resources with a Benefits Factor less than 1 will not be considered

in the regulation clearing because of its reduced benefits. A cap is implemented at Benefits Factor = 1 during these hours. Capped hours are reviewed on a quarterly basis at the Operating Committee.

The Benefits Factor is calculated in ASO one hour ahead in Real-time for each qualified RegD resource participating in the Regulation Market. The Benefits Factor is re-calculated in LPC for each RegD resource that is committed and providing Regulation in Real-time for every five (5) minute interval of the hour. The recalculation accounts for changes in the resource's adjusted total offer cost due to the potential change in LMP at its bus which may affect its Lost Opportunity Cost value. The Benefits Factor of RegA resources is always 1.

The Benefits Factor calculation steps include:

- Step 1: Calculation of the Performance Adjusted MW.

$$\text{Performance Adjusted MW} = \text{Capability (MW)} * \text{Historical Performance Score}$$

- Step 2: Calculation of the Initial Adjusted Total Offer Cost.

$$\text{Initial Adjusted Total Offer Cost (\$)} = \left(\begin{array}{c} \text{Adjusted} \\ \text{Regulation} \\ \text{Capability} \\ \text{Cost} \\ (\$) \end{array} \right) + \left(\begin{array}{c} \text{Adjusted} \\ \text{Lost} \\ \text{Opportunity} \\ \text{Cost} \\ (\$) \end{array} \right) + \left(\begin{array}{c} \text{Adjusted} \\ \text{Performance} \\ \text{Cost} \\ (\$) \end{array} \right)$$

in this step, the resource benefits factor is assumed to be 1

RegD resources with initial adjusted total offer cost equal to zero will still be given priority in the ranking, but will instead be ordered using the resource specific historical performance score as a tie-breaker.

- Step 3: Calculation of the rolling performance adjusted MW based on the initial adjusted total cost in ascending rank order
- Step 4: Calculation of the resource specific Benefits Factor based on the defined Benefits Factor Curve.

3.2.7.7 Three Pivotal Supplier Test

PJM utilizes the Three Pivotal Supplier (TPS) Test in the Regulation Market to mitigate market power as detailed in Attachment K-Appendix, Section 3.2.2A.1 of the PJM Tariff. In ASO, each supplier, from 1 to n, is ranked from the largest to the smallest offered MW of eligible Regulation supply adjusted by the resource-specific Benefits Factor and the resource specific performance score in each hour. Suppliers are then tested in order, starting with the three largest suppliers. In each iteration of the test, the two largest suppliers adjusted by the Benefits Factors of the offered resources and the resource specific performance scores are combined with a third

supplier adjusted by the Benefits Factor of the offered resource and the resource specific performance score, and the resulting combined supply is subtracted from total effective supply adjusted by the Benefits Factors of all offered resources and their resource specific performance scores.

The resulting net amount of eligible supply is divided by the Regulation Requirement for the hour adjusted by the resource-specific Benefits Factors and the resource specific performance scores (D). Where j defines the supplier being tested in combination with the two largest suppliers (initially the third largest supplier with j=3). The equation below shows the formula for the residual supply index for three pivotal suppliers (RSI3):

$$RSI3_j = \frac{\sum_{i=1}^n S_i - \sum_{i=1}^2 S_i - S_j}{D}$$

Where j=3, if RSI3j is less than or equal to 1.0, then the three suppliers are jointly pivotal and the suppliers being tested fail the TPS Test. Iterations of the test continue until the combination of the two largest suppliers and a supplier j result in a RSI3j greater than 1.0. When the result of this process is that RSI3j is greater than 1.0, the remaining suppliers pass the test. Any resource owner that fails the TPS Test is offer-capped.

- Regulating resources are offer-capped at the lesser of their cost-based or market-based regulation offer price.
- An offer-capped resource will only be offer-capped for a single hour at a time as the TPS Test is rerun for each hour of the day.
- Resource merit order price (\$/MWh) = Resource regulation offer + estimated resource opportunity cost per MWh of capability adjusted by the resource-specific Benefits Factor and the resource specific performance score.

3.2.8 Hydropower Units Opportunity Cost

Since hydropower units operate on a schedule and do not have an energy bid, opportunity cost for these units is calculated as follows. Only hydropower units not enrolled in the ESR participation model are considered in the rules below:

- During those hours when a hydropower unit is in spill, the ED value is set to zero such that the opportunity cost is based on the full value of LMP. During the Operating Day, the operating company is responsible for communicating this condition to the PJM Master Coordinator, and indicating this condition on the Regulation Updates page of the Markets Gateway System.
- If a hydropower unit is committed Day-ahead with MW greater than zero, the formula is the same as Section 3.2.7.4 Lost Opportunity Cost (LOC), except the ED value is an average of the LMP at the hydropower unit bus for the appropriate on-peak (07:00 – 22:59) or off-

peak (00:00 – 06:59, 23:00 – 23:59) period, excluding those hours during which all available units at the hydropower plant were operating. If this average LMP value is higher than the actual LMP at the generator bus, the opportunity cost is zero. Day-ahead LMPs are used for the purpose of estimating opportunity costs for hydropower units, and actual LMPs are used in the lost opportunity costs for settlement.

- If a hydropower unit is brought on out of schedule to provide Regulation or not committed in Day-ahead Market with MWs greater than 0, the opportunity cost is equal to the average LMP (calculated as stated above) minus the actual LMP at the generator bus. If the actual LMP is higher than the average, the opportunity cost is zero.
- When determined to be economically beneficial, PJM maintains the authority to adjust hydropower unit schedules for those units scheduled by the owner if the owner has also submitted a regulation offer for those units and made the units available for Regulation.
- An example of Regulation Hydropower Lost Opportunity Cost Calculations can be found on the PJM website at <https://pjm.com/-/media/markets-ops/ancillary/regulation-uplift-and-lost-opportunity-cost.ashx?la=en>.

3.2.8.1 Hydropower Operation

The eDART Hydro Calculator application is used to generate and coordinate hydropower schedules within PJM. Generation information collected includes pumping and generation megawatts, river flows and pond/reservoir levels. Generators submit schedules directly into the Hydro Calculator application or generators information is obtained from the Day-ahead commitment. This allows PJM Dispatchers the ability to determine when the units are scheduled to come online/offline. PJM Dispatchers may adjust hydropower schedules based on generation owner request or weather conditions and river levels.

During normal operations hydropower generation owners may:

- Follow their Day-ahead commitment.
- Request to bring on additional hydropower generation or pumping outside of the Day-ahead commitment.
 - Additionally, PJM Dispatch may request to bring on additional hydropower generation or pumping outside of the Day-ahead commitment.
- Come online for reliability such as Synchronous Reserve Events.

Depending on system conditions, PJM may accommodate changes in schedule. To facilitate these actions in RT SCED, Dispatchers may enter the anticipated generation or pumping output of the hydropower resource as a hydropower schedule. This hydropower schedule is used to replace the State Estimator value in anticipation of system conditions and utilized as input in RT SCED as defined in Section 2.5.3.5 of this Manual.

3.2.9 Regulation Market Operations

The PJM dispatcher periodically evaluates the set of resources providing Regulation, and makes any adjustments to regulation assignments deemed necessary and appropriate to minimize the overall cost of Regulation.

In the event of a Regulation excess, the PJM dispatcher deselects resources beginning with the highest cost resource currently providing Regulation and moving downward.

In the event of a Regulation deficiency, the PJM dispatcher uses the Intermediate-Term Security Constrained Economic Dispatch (IT SCED) application to select resources to provide Regulation beginning with the lowest cost resource currently not providing Regulation and moving upward.

The RMCP and therefore RMPCP and RMCCP may change based upon regulating resource adjustments made in Real-time. Any opportunity costs that exceed the RMCP are credited after the fact on a resource-specific basis.

The PJM Energy Management System (EMS) will send a RTO based signal(s) to each Local Control Center (LCC), as well as signals to individual resources or plants as requested by the owner.

The PJM dispatcher communicates any change in resource regulating assignments to individual LCCs. Company total in-service regulating capabilities are then telemetered back to the PJM EMS via the PJM data link or other approved methods.

Resource regulation assignment changes during transitions between on-peak and off-peak periods begin thirty (30) minutes prior to the new period, and are completed no later than thirty (30) minutes after the period begins.

For a dual qualified regulation resource, the signal assignment cannot change within the operating hour; therefore, the resource will continue to be committed or re-committed on the regulation signal type that the resource was initially committed on.

The historic performance score is calculated upstream of the market clearing process as discussed in PJM Manual 12: Balancing Operations, Section 4.4.5 Disqualification and Requalification of a Resource. If the daily historic performance scores for an Operating Day are not available due to a system failure or other issues that affect the calculation of the historic performance scores for all resources, the latest available historic performance scores from the last three (3) days is used. If no historic performance scores are available from the last three (3) days, then the latest available regulation qualification or regulation requalification test score for each resource by signal type is used.

3.2.10 Settlements

A resource's regulation performance score for each five (5) minute Real-time Settlement Interval it is regulating will determine the resource's eligibility for regulation credit and lost opportunity

cost for that interval. A resource whose performance score for the Real-time Settlement Interval that is below 25% will forfeit regulation credit and lost opportunity for that interval.

Please refer to PJM Manual 28: Operating Agreement Accounting, Section 4: Regulation Accounting for complete settlement details.

Section 4: Overview of the PJM Reserve Market

Welcome to the Overview of the PJM Reserve Markets section of the PJM Manual for Energy & Ancillary Services Market Operations. In this section, you will find description of Synchronized Reserve, Primary Reserve, and 30-Minute Reserve Services and the Synchronized Reserve, Non-Synchronized Reserve, and Secondary Reserve Products as applied in both Day-ahead and Real-time Reserve Markets and Operations.

4.1 Overview of the PJM Reserve Markets

The PJM Reserve Markets provide PJM participants with a market-based system for the purchase and sale of the Synchronized Reserve, Primary Reserve, and 30-minute Reserve Services (“Reserves”). The PJM Reserve Markets are conducted in both the Day-ahead Market and Real-time Market processes. In the Day-ahead Market, PJM schedules Reserves on a simultaneously, co-optimized basis with Energy for each hour of the next Operating Day. In Real-time, PJM procures Reserves on a simultaneously, co-optimized basis with Energy for each hour and each interval.

Both the Day-ahead and Real-time Reserve Markets are offer-based and procure resources to meet the required Reserve Services:

- Synchronized Reserve Service: can only be satisfied by online resources that are able to respond in ten (10) minutes or less.
- Primary Reserve Service: can be satisfied by online or offline resources that are able to respond in ten (10) minutes or less.
- 30-Minute Reserve Service: can be satisfied by online or offline resources that are able to respond in thirty (30) minutes or less.

PJM has three reserve products that can meet the required Reserve Services:

- Synchronized Reserve Product: online resources that are able to respond in ten (10) minutes or less. The Synchronized Reserve product can satisfy the Synchronized Reserve, Primary Reserve, and 30-Minute Reserve Services.
- Non-Synchronized Reserve Product: offline resources that are able to respond in ten (10) minutes or less. The Non-Synchronized Reserve product can satisfy the Primary Reserve and 30-Minute Reserve Services.
- Secondary Reserve Product: online or offline resources that are able to respond between ten (10) and thirty (30) minutes. The Secondary Reserve product can satisfy only the 30-Minute Reserve Service.

The Synchronized Reserve, Non-Synchronized Reserve and Secondary Reserve products have a priority sequence based on the level of reliability which each provides. Synchronized Reserve,

being the most reliable as it is online and can respond in ten (10) minutes or less, can also meet the Primary and 30-Minute Reserve requirements. Likewise, Non-Synchronized Reserve can also meet the 30-Minute Reserve requirement. Since the system operates in the most economical manner while satisfying each reserve requirement, economics dictate the extent to which more reliable reserve excesses are applied to subordinate reserve categories.

Day-ahead and Real-time Reserve Services



Reserve Services and the Reserve Products that can satisfy the requirements:

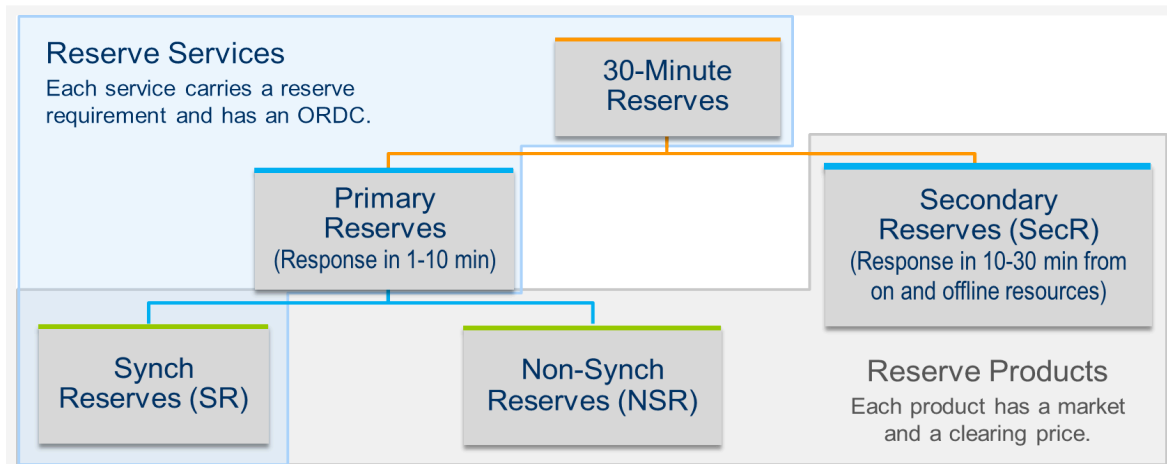

Each Load Serving Entity (LSE) on the PJM system incurs a Reserve Obligation in kWh based on their Real-time load ratio share and the procured supply to meet each Reserve product. For more information on LSE Reserve obligations, refer to section 4.6 of this Manual.

For more information on how PJM monitors and restores reserves, refer to PJM Manual 12: Balancing Operations.

For information on the Reserve Requirements, refer to PJM Manual 13: Emergency Operations.

The following sections apply to both the Day-ahead and Real-time Market, unless specifically stated.

4.2 PJM Reserve Market Offer Business Rules

4.2.1 Reserve Market Eligibility

In general, Generation, Hybrid Resources, Energy Storage Resources, and Economic Load Response resources are eligible to provide Synchronized Reserves, Non-Synchronized Reserves, and Secondary Reserves except if:

- The resource is not within the metered boundaries of PJM
- The entire output is offered as Emergency Only
- The resource type includes: Nuclear, Wind, or Solar, unless an exception is requested and approved
- The resource is not available to provide energy or reduce load

In addition, the following resources are not eligible to provide Non-Synchronized Reserves:

- Economic Load Response
- Hybrid Resources
- Energy Storage Resources enrolled in the ESR participation model
- Pumped hydro resources that are not participating in the PJM optimized pumped storage model in the Day-ahead market and if Initial MW is greater than zero in the Real-time market

Generation resources must be able to provide 0.1 MW of Reserve Capability in order to participate in the Reserve Markets.

In the event PJM forecasts a credible natural gas pipeline contingency(s), as described in PJM Manual 13: Emergency Operations, Section 3.9, PJM Dispatch will determine the eligibility of resources to provide Reserves depending on the severity of the contingency and other system conditions in order to ensure system reliability is maintained.

4.2.1.1 Requests for Eligibility for Nuclear, Wind, Solar Resources

The Market Seller of a nuclear, wind, or solar resource may obtain approval for the resource to be considered eligible to provide reserves by submitting to PJM and the MMU a written request for exemption and provide documentation to support the resource's ability to follow dispatch at the direction of PJM, such as historical operating data showing voluntary response to reserve

events and/or technical information about the physical operation of the resource. Requests and questions may be submitted by Market Sellers to Reserves@pjm.com.

PJM and the MMU will review, in an open and transparent manner as between the Market Seller, the MMU, and PJM, the information and documentation in support of the request for approval to provide reserves.

PJM will determine, with the advice and input of the MMU, whether the resource will be permitted to provide reserves and provide written notification to the Market Seller of such determination no later than 30 business days from the date of data submittal supporting the request. If the request is denied, PJM will include in the notice a written explanation for the denial.

4.2.1.2 Economic Load Response Reserve Eligibility

- Economic Load Response must successfully complete Ancillary Services certification in PJM's DR Hub system to participate in PJM's Reserve Markets.
- Economic Load Response must be able to provide 0.1 MW of Reserve Capability in order to participate in the Reserve Markets.
 - See section 10.5 in this Manual for Economic Load Response aggregation rules to meet the 0.1 MW threshold for locations that have capability less than 0.1 MW.
- Economic Load Response providing reserves are required to provide after-the-fact meter data at a one (1) minute interval for each location called on to respond in a reserve event.
- Residential locations without meters recording at a one (1) minute interval or shorter may participate using the statistical sampling method detailed in PJM Manual 19: Load Forecasting and Analysis, Attachment C and subject to PJM approval.
- After-the-fact one (1) minute meter data for locations called on to respond in a reserve event must be submitted into PJM's DR Hub system no later than two (2) business days following the event day.
- Economic Load Response Curtailment Service Providers not providing complete, accurate and timely meter data for locations called on to respond in a reserve event may be suspended from participating in the Reserve Markets until corrective measures are implemented and may be referred to the PJM Market Monitor and/or the FERC Office of Enforcement for further investigation as necessary.
- Economic Load Response Curtailment Service Providers must complete initial and continuing training on Regulation and Reserve Markets as documented in PJM Manual 40: Training and Certification Requirements, Section 3.2.5: Demand Response Resources.
- Whenever Economic Load Response assigned in the Reserve Markets is called on to respond to a mandatory Emergency or Pre-Emergency Load Management Event, it will be de-assigned from Reserves for any intervals that overlap with the Load Management Event, starting from the notice time of the Load Management Event, unless otherwise

approved by PJM. PJM will not assign the resource to Reserves for the remainder of the mandatory portion of the Load Management Event.

- Economic Load Response that demonstrate the ability to receive reserve commitments via approved telemetry (e.g. Jetstream) qualify as a Flexible resource. Otherwise, Economic Load Response resources are regarded as Inflexible resources.

4.2.2 Reserve Resource Offer Requirements

- Any generator that is a PJM generation capacity resource that has a Reliability Pricing Model (RPM) or Fixed Resource Requirement (FRR) Resource commitment that is eligible to provide Reserves must offer their 10-minute and 30-min reserve capability, unless the unit is unavailable due to an approved planned outage, maintenance outage or forced outage.
 - If a resource that has a reserve must offer requirement chooses to not make its reserve capability available, for example through self-scheduling or offering a fixed output, when the resource is otherwise able to operate with a dispatchable range, the resource is defined to be violating the reserve must offer requirement.
 - All other generation resources that are eligible to provide reserves that have submitted Energy offers are considered to have offered the unit's applicable capability into the reserve markets.
 - Hydroelectric, Economic Load Response, Hybrid Resources and Energy Storage Resources (ESR) are not considered available by default, and must submit specific reserve offers to be considered. Hydroelectric, Economic Load Response, Hybrid Resources and Energy Storage Resources reserve offers must be based on their realistic achievable ramp rate and current operating conditions taking into account all constraints (e.g. regulatory, environmental, operational). Any Hydroelectric, Hybrid Resource or Energy Storage resource with a reserve must offer requirement that cannot provide reserves at any time must communicate to PJM and the MMU the reasons why it cannot provide reserves at Reserves@pjm.com.
 - For multiple physical units that are modeled as an aggregated resource in the Market system, if at least one of the physical units are online, then the aggregate is considered online and may be considered for online synchronized and/or online secondary reserves, but not eligible for non-synchronized reserve.
 - Any offline units belonging to an online aggregated resource that have the capability of providing reserves are subject to the must offer requirement and PJM will treat the offline reserves as synchronized reserves. Hydroelectric, Hybrid Resources and Energy Storage Resources must include the available offline reserves in their synchronized reserve offer.

4.2.2.1 Communication for Reserve Capability Limitation

A generation resource owner may request a lesser synchronized reserve maximum or secondary reserve maximum than the economic maximum if a physical limitation exists that

cannot be addressed using the multi-segmented hourly ramp rate or using the Real-time reserve deselection exception process as described in Section 4.4.3.1. Resource owners must submit requests to Reserves@pjm.com. A copy of this email will be made available to the MMU.

The request must include the Markets Gateway unit name, unit ID, reason, and documentation to support the request. PJM will determine, with the advice and input of the MMU, whether the request is approved or denied and provide a written notification to the generation resource owner no later than 30 business days from the date of data submittal supporting the request. If the request is denied, PJM will include in the notice a written explanation for the denial.

4.2.3 Reserve Market Resource Offer Structure

- All generation resources that have submitted energy offers and are eligible to provide reserves, as defined in Section 4.2.1 above, will be considered as offered into the Reserve markets.
 - This excludes hydropower resources, Hybrid Resources and Energy Storage Resources who must submit specific Reserve offers to be considered.

Reserve offers consist of three elements: availability, offer MW, and offer price and vary depending on the type of resource and the market in which the resource is participating. Resource specific rules are detailed below.

Availability

Reserve Market	Resource Type				
	Condensers	Other Gen	Wind/Solar/Nuclear	ESR/Hydro/Hybrid Resource	Load Response
SR	Set through energy offer			Specify availability separately	
NSR				N/A for ESR and Hybrid Resource; Specify availability separately for hydro	N/A for NSR
SecR				Specify availability separately	

- Availability for generation not including ESR, Hybrid Resources and hydro resources is set through Energy Offer availability status.
- Hydroelectric, ESR, Hybrid Resources and Economic Load Response resources have the ability to separately specify the availability for Reserves.
- Should a Hydro, ESR, Hybrid Resource and Economic Load Response resource be unable to participate in the Reserve Market in any given hour on the Operating Day, the following

required updates should be made sixty-five (65) minutes prior to the operating hour in the Reserve Market Updates screens of Markets Gateway:

- Set Offer MW to zero.
- Set Availability to 'Not Available'
- Resources are able to self-schedule into the Synchronized Reserve Market only.
 - Eligible ESR, Hybrid Resources, Hydroelectric, and Economic Load Response resources that choose to self-schedule will use their submitted Offer MW quantity as the self-schedule Reserve Offer MW.
 - A resource's choice to self-schedule or provide fixed output does not alter its capability to provide reserves. Self-scheduled units must provide reserves like all other online generating resources

Offer MW

- PJM will calculate the Reserve MW quantity available from each generation resource, not including ESR, Hybrid Resources and Hydroelectric resources, based on the bid in energy parameters, reserve parameters, Regulation status and current energy output data as described in Section 4.2.5 of this Manual.
- Other resources, may specify offer MW values as described below, where:
 - Synchronized Reserve offer MW is reserve capability of a resource that can be converted fully into energy in ten (10) minutes, or the load reduction achievable in ten (10) minutes and is provided by equipment electrically synchronized to the system.
 - Non-Synchronized Reserve offer MW is reserve capability of a resource that can be fully converted into energy within ten (10) minutes and is provided by equipment not electrically synchronized to the system.
 - Secondary Reserve offer MW is reserve capability of a resource that can be converted fully into energy after ten (10) minutes and before thirty (30) minutes, or the load reduction achievable after ten (10) minutes and before thirty (30) minutes by equipment which may not necessarily at the time of the request be electrically synchronized to the system.

The ability to specify an Offer MW varies by resource type, as described below:

Parameter	Reserve Market	Resource Type				
		Condensers	Other Gen	Wind/Solar/Nuclear	ESR/Hydro/Hybrid Resource	Load Response
Offer MW	SR*	Via PJM calculate capability MW			Yes	Yes
	NSR				Yes (N/A ESR/Hybrid Resource)	N/A
	SecR*				Yes	Yes

*Resources able to specify separate Offer MW can update in real-time up to 65 minutes prior to start of operating hour

- The Offer MW for generation resources not including ESR, Hybrid Resources, and hydro resources is calculated for all applicable intervals by PJM as described in Section 4.2.5
- Hydroelectric resources must separately specify an Offer MW for Synchronized, Non-Synchronized, and Secondary Reserves
- ESR, Hybrid Resources and Economic Load Response resources must separately specify an Offer MW for Synchronized and Secondary Reserves. Note: ESR, Hybrid Resources and Economic Load Response resources are not eligible to provide Non-Synchronized Reserves.
- Offer quantities specified on the Synchronized Reserve Offer, Non-Synchronized Reserve Offer, and Secondary Reserve Offer pages in Markets Gateway for Hydroelectric, ESR, Hybrid Resources or Economic Load Response resources that are also capacity resources are automatically carried over from one day to the next.
- Changes made on the Synchronized Reserve Updates, Non-Synchronized Reserve Updates, and Secondary Reserve Updates pages of Markets Gateway are not carried over into the next market day. Any changes made to the Synchronized Updates, Non-Synchronized Reserve Updates, and Secondary Reserve Updates pages supersedes the values on the Offer pages.
- Resources permitted to specify an Offer MW may specify hourly values, and update up to 65 minutes prior to the start of the operating hour as specified in Section 9.1. Hourly offer MW for reserves must remain up to date and accurate for capacity resources to comply with the reserve must offer requirement.

Offer Price

Parameter	Reserve Market	Resource Type				
		Condensers	Other Gen	Wind/Solar/ Nuclear	ESR/Hydro/ Hybrid Resource	Load Response
Offer Price	SR	Yes, cannot exceed expected value of penalty				
	NSR	N/A				
	SecR	N/A				

- All resources may specify a Synchronized Offer Price (\$/MWh)
 - Synchronized Reserve offer prices must be cost-based and are capped at the Expected Value of Synchronized Reserve Penalty.
 - The Offer Price cannot be a negative value
 - All resources listed as available for Synchronized Reserves with no Offer Price have their Offer Prices set to \$0.00/MWh.
- The Expected value of Synchronized Reserve Penalty = Average Penalty Rate (\$/MWh)*Probability of an event*Probability of underperformance, as specified in Manual 15.
- Offer prices for Non-Synchronized Reserve and Secondary Reserve are \$0.00/MWh and are not able to be submitted in Markets Gateway
- Shutdown Cost (\$/MWh): This is the cost Economic Load Response incurs when reducing load in response to a reserve event and must be zero.

4.2.4 Offer Period Timing

- Day-ahead Reserve Market Offers for eligible generators or Economic Load Response resources must be supplied prior to 11:00 day-ahead.
- Real-time Reserve Market Offers must be supplied prior to 14:15 day-ahead except when specifying hourly updates.
 - Parameters that may be updated hourly up to sixty five (65) minutes prior to the start of the operating hour include:
 - Offer MW (if eligible)
 - Availability (if eligible)
 - Synchronized Reserve Offer Price (\$/MWh) (if opted in to Intraday Updates as detailed in Section 9.1.1)
 - Synchronized Reserve Self-schedule status
 - Parameters that may be updated within the operating hour include:

- Synchronized Reserve Maximum MW, if eligible
- Secondary Reserve Maximum MW, if eligible
- Any hourly updates supersede the values on the daily Offers page.
- The Real-time Market Clearing Engines will use the offered in parameters as detailed in Sections 2.5 and 2.7 of this Manual.

4.2.5 Reserve Market Resource Capability

PJM will calculate the Synchronized Reserve, Non-Synchronized Reserve, and Secondary Reserve capability available from generation resources that are not able to specify an Offer MW.

4.2.5.1 Reserve Market Capability for Online Generation Resources

PJM will calculate the Synchronized Reserve (SR) and Secondary Reserve (SecR) MW quantity available for online resources that are ineligible to submit an Offer MW, based on the following offer parameters submitted as part of the resource's energy offer:

- Initial energy output
- Ramp rate
- Economic Minimum
- The lesser of Economic Maximum and Synchronized Reserve maximum MW or Secondary Reserve maximum MW, where Synchronized Reserve maximum MW or Secondary Reserve maximum MW may be lower than the Economic Maximum only where the Market Seller has been approved to submit a lower value as described in Section 4.2.2.1 of this Manual.

SR MW Capability = $\max \{0, \min [\min(\text{EcoMax}, \text{Synch Max}) - \text{Initial Energy Output}, \text{RampRate} * 10 \text{ minutes}]\}$

SecR MW Capability = $\max \{0, \min [\min(\text{EcoMax}, \text{SecR Max}) - \text{Initial Energy Output}, \text{RampRate} * 30 \text{ minutes}] - \text{SR MW}\}$

4.2.5.2 Reserve Market Capability for Offline Generation Resources

PJM will calculate the Non-Synchronized (NSR) and Secondary Reserve (SecR) MW quantity available for offline resources that are ineligible to submit an Offer MW, based on the following offer parameters submitted as part of the resource's energy offer:

- Startup and notification times
- Ramp rate
- Economic Minimum
- The lesser of Economic Maximum and Secondary Reserve Maximum MW, where Secondary Reserve maximum MW may be lower than the Economic Maximum only if the

Market Seller has been approved to submit a lower value as described in Section 4.2.2.1 of this Manual

NSR MW Capability = $\max \{0, \min [\text{EcoMax}, \text{EcoMin} + (10 - \text{Startup} - \text{NotificationTime}) * \text{RampRate}]\}$

SecR MW = $\max \{0, \min [\min (\text{EcoMax}, \text{SecRMax}), \text{EcoMin} + (30 - \text{Startup} - \text{NotificationTime}) * \text{RampRate}] - \text{NSR MW}\}$

4.2.5.3 Reserve Market Capability for Synchronous Condensers

PJM will calculate the Synchronized Reserve and Secondary Reserve MW quantity available for resources capable of synchronous condensing based on the following offer parameters submitted as part of the resource's energy offer:

- Ramp rate
- Condense to generation time constraints
- Economic Minimum
- The lesser of Economic Maximum and Synchronized Reserve maximum MW or Secondary Reserve maximum MW, where Synchronized Reserve maximum MW or Secondary Reserve maximum MW may be lower than the Economic Maximum only if the Market Seller has, in accordance with the procedures set forth in the PJM Manuals, submitted justification to PJM that the resource has an operating configuration that prevents it from reliably providing Synchronized Reserves above the Synchronized Reserve maximum MW

SR MW Capability = $\max \{0, \min [\min (\text{EcoMax}, \text{SynchMax}), \text{EcoMin} + \text{RampRate} * (10 \text{ minutes} - \text{condense to gen time})]\}$

SecRMW Capability = $\max \{0, \min [\min (\text{EcoMax}, \text{SecR Max}), \text{EcoMin} + \text{RampRate} * (30 \text{ minutes} - \text{Condense to gen time})] - \text{SR MW}\}$

Synchronous Condensers can submit the following additional offer parameters:

- ~~Condense Energy UseUsage for reserve condensing resources (MW): This is the amount of instantaneous energy a condensing resource consumes while operating in the condensing mode. The value submitted as part of the Reserve offer must be less than or equal to the actual energy consumed as observed in real time.~~
- ~~Condense to Generate. Cost: This is the cost of transitioning a condenser to generating mode. The value submitted for this cost must be less than or equal to the condensing Startup Cost.~~
- ~~Condense Startup Cost: This is the actual cost associated with getting a resource from a completely off line state into the condensing mode including fuel, O&M, etc.~~

- ~~Condense Hourly Cost: This is the hourly cost to condense and is equal to the actual, variable O&M costs associated with operating a resource in the condensing mode, including any fuel costs. It does not include any estimate for energy consumed~~
- Condense Notification Time: The amount of advance notice, in hours, required to notify the operating company to prepare the resource to operate in synchronous condensing mode. The default value is zero hours.
- Reserve as Condenser: This is used to identify if a resource can be committed from offline state for Synchronized Reserve or Secondary Reserve as a condenser.
- Condense Available Status: This indicates a resource's availability to provide voltage and/or reactive support. This value is not directly related to the Synchronized Reserve or Secondary Reserve Markets.

4.2.5.4 Reserve Market Capability for Hydropower Resources

Hydroelectric and Pumped Storage Hydropower Resources that offer their full capability as energy and have the capability of reducing output in order to provide reserves will have to offer reserve MW that are not self-scheduled. PJM will assign reserves to these resources economically based on the equation below:

$$\text{Reserve MW Capability} = \text{MAX} (0, \text{MIN} (\text{Eco Max} - \text{Eco Min}, \text{Reserve Offer MW}))$$

Hydroelectric and Pumped Storage Hydropower Resources that do not offer their full instantaneous capability as energy and have the capability of increasing output within 10 or 30 minutes will have to self-schedule reserve MW and adjust their Eco Max to equal the sum of scheduled energy MW and scheduled reserve MW. PJM will assign energy to these resources that will not exceed their capability based on the equation below:

$$\text{Max Energy} = \text{Eco Max} - \text{Reserve Offer MW}$$

Where Reserve Offer MW equals the reserve capability taking to account all constraints (e.g. regulatory, environmental, operational). Reserve Offer MW will be distinct for Synchronized Reserves, Non-synchronized Reserves and Secondary Reserves.

Eco Max must reflect the full capability that the resource could provide if PJM calls on reserves to preserve system reliability.

Pumped Storage Hydropower Resources that have the capability of providing reserves during pumping mode by curtailing MW must offer such capability.

4.3 Reserve Requirement Determination

PJM models a reserve requirement at the RTO and sub-zonal level in whole MW for each hour of the operating day based on the greatest MW loss of all potential Largest Single

Contingencies on the system. The table below describes the reliability and reserve requirements for each Reserve Service.

	Reserve Service		
	Synchronized Reserve (SR)	Primary Reserve (PR)	30-Minute Reserve (30-Min)
Reliability Requirement	Largest Single Contingency	150% of Synchronized Reserve Reliability Requirement	Greater of (Primary Reserve Reliability Requirement, 3000 MW, or largest active gas contingency)
Reserve Requirement	SR Reliability Requirement + Extended Reserve Requirement	PR Reliability Requirement + Extended Reserve Requirement	30-Min Reliability Requirement + Extended Reserve Requirement

- In order to meet Reliability First (RF) Regional Criteria, PJM may schedule additional Contingency Reserves on a temporary basis in order to meet the Largest Single Contingency, as necessary to account for resource performance. PJM shall post details regarding additional scheduling of reserves in Markets Gateway.
- The Largest Single Contingency in Day-ahead is normally the largest Economic Maximum value for all available schedules or the summation of the largest Economic Maximum value for all available schedules of an active reserve group for the hour.
- The Largest Single Contingency in Real-time is normally the higher of [max of (the largest online generator's output or Economic Maximum) or the sum of the higher of (Economic Maximum values or outputs of an active reserve group)].
- An active reserve group is a model of a station with multiple generation resources with a total capacity in excess of 800 MW, where there is a single outlet or where a single fault would trip multiple generation resources at the station.
- For purposes of the 30-Minute Reserve Requirement, the largest gas contingency is calculated as the summation of the Economic Maximum values of the identified resources
- Only those potential Largest Single Contingencies communicated by PJM Operations and modeled in the market clearing software will be eligible to set the applicable reserve requirements used in the market clearing process.

- There are, at times, outage conditions at stations whereby a single fault would trip multiple generators resulting in a loss of generation greater than the Largest Single Contingency. In such instances, PJM will carry an increased Reserve Requirement in equivalent summation of output of those multiple generators in accordance with Reserve Requirements described in PJM Manual 13: Emergency Operations, Section 2.2.
- At times, anticipated heavy load conditions may result in PJM operators carrying additional reserves to cover increased levels of operational uncertainty. PJM may extend the 30-Minute Reserve, Primary Reserve and Synchronized Reserve Requirements in the Market Clearing Engine during the on-peak period in order to incorporate these actions in Energy and Reserve Pricing when a Hot Weather Alert, Cold Weather Alert or an escalating emergency procedure (as defined in PJM Manual 13: Emergency Operations) has been issued for the Operating Day. The extended Synchronized Reserve Requirement, extended Primary Reserve Requirement and extended 30-Minute Reserve Requirement will be equal to the existing extended applicable Reserve Requirement plus the sum of any additional MW brought online for that hour by PJM dispatch to account for operational uncertainty.
 - If reserve deliverability issues are anticipated, then the requirements for the active Sub-Zone(s) in which the additional resources are located may be extended. For example, if additional resources are specifically scheduled in the active Sub-zone in anticipation of transmission constraints inhibiting the delivery of reserves into that region, both the active Sub-zone and RTO Reserve Zone requirements would be extended.
 - If the additional resources are scheduled in the RTO Reserve Zone, then only the RTO Reserve Zone requirement would be extended.
- The requirements will return to their original values upon exit from emergency procedures or when the additional resources have been released by PJM dispatch.
- PJM will notify market participants of changes to the Reserve Requirements in relation to emergency procedures via the Emergency Procedure Posting Application once the decision to change the Reserve Requirements is made.
- Regardless of the Reserve Requirements modeled in the Market Clearing Engine, PJM operators will continue to initiate emergency procedures based on the Reserve Requirements defined in PJM Manual 13: Emergency Operations.
- Each Reserve Requirement will have an associated reserve demand curve as specified in Section 4.3.3 of this Manual.

4.3.1 Locational Aspect of Reserves

Due to transmission security considerations on the PJM system, it is necessary to carry a minimum amount of Synchronized Reserve, Primary Reserve, and 30-Minute Reserve in a specific sub-zone in PJM such that loading 100% reserve will not result in an overload of any of the PJM transfer interfaces. The main goal of procuring locational reserves is to not overload critical transmission constraints when reserves are deployed.

- While PJM can model multiple sub-zones, only one will be active at any given time.
- 30-minute Reserves will not model a sub-zone by default. In the event one is modeled, it will be communicated to participants via Markets Gateway.
- Active sub-zones will be communicated to the Market Participants via Markets Gateway.

Analysis to determine the lists of generation and load buses with respect to the defined reserve sub-zones is performed at least once with each quarterly network model update. The current sub-zone list resulting from this analysis can be found in [pjm.com](https://www.pjm.com/markets-and-operations/ancillary-services) at this link:

<https://www.pjm.com/markets-and-operations/ancillary-services>.

4.3.2 Creation of New Reserve Subzones

As system conditions dictate, PJM may need to model new sub-zones into the Reserve Markets to better support reliable operations and produce market results that are more consistent with system operating conditions. New reserve sub-zones may be defined for constraints in three categories:

- Reactive transfer interfaces (AP South, BED-BLA, etc.)
- 230kV or above actual overload constraint (i.e. Conastone-Peach Bottom 500kV actual overload)
- Contingency overload exceeding the load dump limit on a 230kV or above facility

New reserve sub-zones will be defined as far in advance as possible, but will not be created on a same-day basis. The active Sub-zone will be determined for each day on a day-ahead basis. Changes to the reserve sub-zone in use can be made after the close of the day-ahead market (including intraday) on an exception basis. Stakeholders will be notified of all switches in the modeled reserve sub-zone via Markets Gateway as soon as possible. Only one sub-zone will be active at any given time and will be communicated in the Markets Gateway application. Reserve sub-zone definitions will be published quarterly coincides with the network model builds.

4.3.3 Reserve Demand Curves and Penalty Factors

Embedded within the Day-ahead and Real-time Market Clearing Engines are Reserve Demand Curves for each Reserve service in each Reserve Zone and Sub-Zone. These demand curves are used to articulate the value of maintaining reserves at specified levels and ensure product substitution between energy and reserves up to the specified penalty factors. They are defined with \$/MWh penalty factors on the Y axis and desired reserve MW on the X axis. The penalty factor represents the price at which reserves will be valued if the desired reserve MW cannot be met with the available reserves on the system, and also acts as a price cap beyond which reserves will not be procured through market clearing.

- For example, assume the penalty factor to maintain 1,000 MW of Synchronized Reserves is \$850/MWh. If there are less than 1,000 MW of reserves available, the deficient MW will be valued at \$850/MWh. Similarly, if there are sufficient reserves to meet the 1,000 MW requirement, yet they are not available at prices less than or equal to \$850/MWh,

resources with merit order prices that exceed \$850/MWh will not be cleared and the deficient MW will be valued at \$850/MWh. However, such resources can still be committed manually by PJM operations personnel in order to maintain reliability. In this case, such resources will be compensated additionally after the fact to ensure their true cost to provide the service is covered.

The penalty factor also provides a clear indicator of the reserve position of the RTO and modeled Reserve Sub-Zones. As the price of a reserve product increases to a value near the penalty factor, it indicates to market participants that the system is nearing a reserve shortage. Separate demand curves exist for each of the following reserve product / Reserve Zone or Sub-zone combinations:

- RTO Synchronized Reserve
- Active Sub-Zone Synchronized Reserve
- RTO Primary Reserve
- Active Sub-Zone Primary Reserve
- RTO 30-Minute Reserves
- Active Sub-zone 30-Minute Reserves (if applicable)

The demand curves for each of these products and locations are similar in that they share the same penalty factors on the Y axis; however, the desired reserve levels on the X axis differ to reflect the Reserve Requirement differences amongst the reserve products and locations.

These demand curves are defined as follows:

- Step 1:
 - Penalty Factor = \$850/MWh
 - Desired Reserve MW = locational Reliability Requirement for the specified reserve product as defined in Section 4.3 above.
- Step 2:
 - Penalty Factor = \$300/MWh
 - Desired Reserve MW = locational Reliability Requirement for the specified reserve product as defined in Section 4.3 above plus 190 MW plus any additional reserves that are being carried in anticipation of heavy load conditions, as referenced in Section 4.3 above.

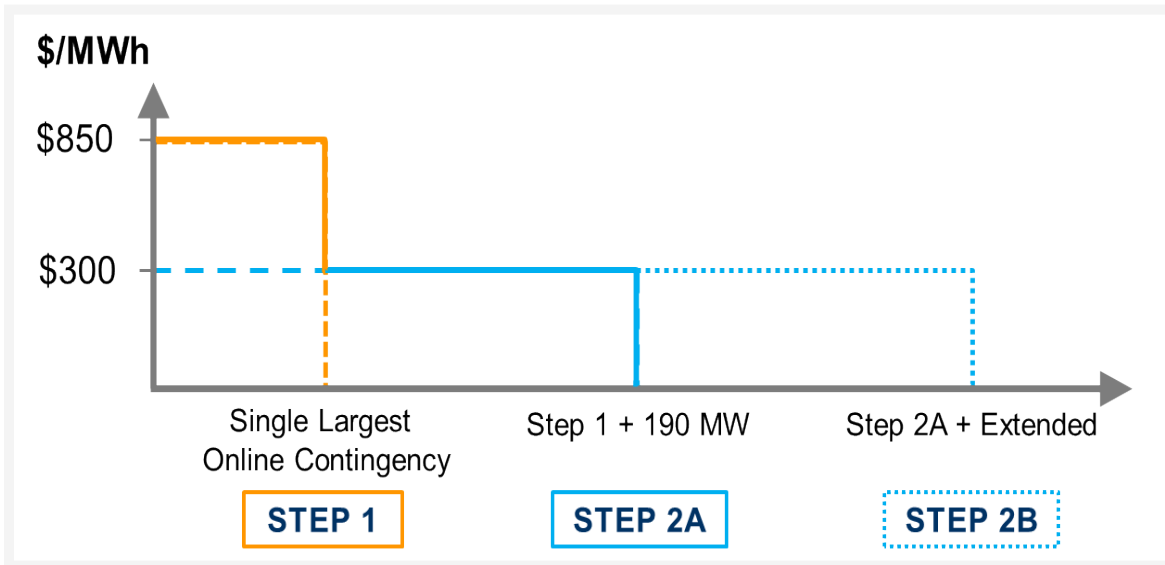

- In the Day-ahead Market, due to the Reserve Requirements being based on the largest Economic Maximum value, as described in Section 4.3, the MW values may change hourly.
- In the Real-time Market, due to the Reserve Requirements being based on the Real-time Largest Single Contingency, the MW values on the X axis of the demand curves used in market clearing can change dynamically with each Real-time market clearing case execution. Below is an example of what the demand curve for Synchronized Reserves would look like if the output of the Largest Single Contingency was 1,210 MW for that specific case execution.

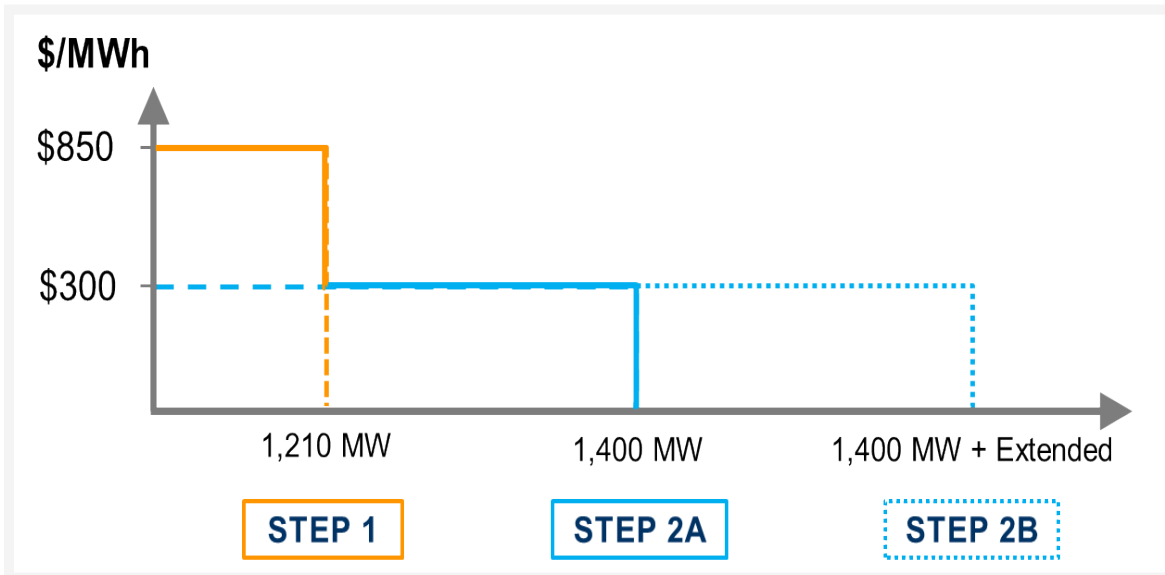

4.4 Reserve Market Clearing

PJM schedules resources as needed to meet the Reserve Requirements of each Reserve Zone and active sub-zone via joint optimization with energy in both the Day-ahead and Real-time markets. Resources are scheduled based on the resource-specific offer data submitted as defined in Section 4.2 of this Manual and the product substitution cost of providing energy or any other product the resource is capable of providing. The joint optimization seeks to procure and minimize the total production cost of energy and meeting the various reserve requirements as described in Section 4.3 of this Manual, and in the Real-time Market, the Regulation Requirement as described in Section 3.2.4 of this Manual.

Reserves and energy will be co-optimized the same way in the Day-ahead and Real-time Market.

The same reserve zone configuration will be modeled in the Day-ahead and Real-time markets unless there is an operational emergency requiring it to be changed in the Real-time market.

4.4.1 Product and Locational Substitution

As described in Section 4.1, the Synchronized Reserve, Non-Synchronized Reserve and Secondary Reserve products have a priority sequence based on the level of reliability which each provides. Synchronized Reserve, being the most reliable as it is online and can respond in ten (10) minutes or less, can also meet the Primary and 30-Minute Reserve requirements. Likewise, Non-Synchronized Reserve can also meet the 30-Minute Reserve requirement.

In addition, the location of the reserves procured also have a hierarchy. Reserves procured in a sub-zone can also meet the requirement of the RTO.

As a result, a megawatt cleared in a subzone for Synchronized Reserves can also be used to meet the RTO Synchronized Reserve Requirement, the subzone Primary Reserve Requirement, the RTO Primary Reserve Requirement, the subzone 30-minute Reserve Requirement (if modeled), and the RTO 30-minute Reserve Requirement.

PJM will commit the most economic combination of resources to simultaneously meet all energy and reserve requirements.

The graphic below illustrates the product and locational substitution.

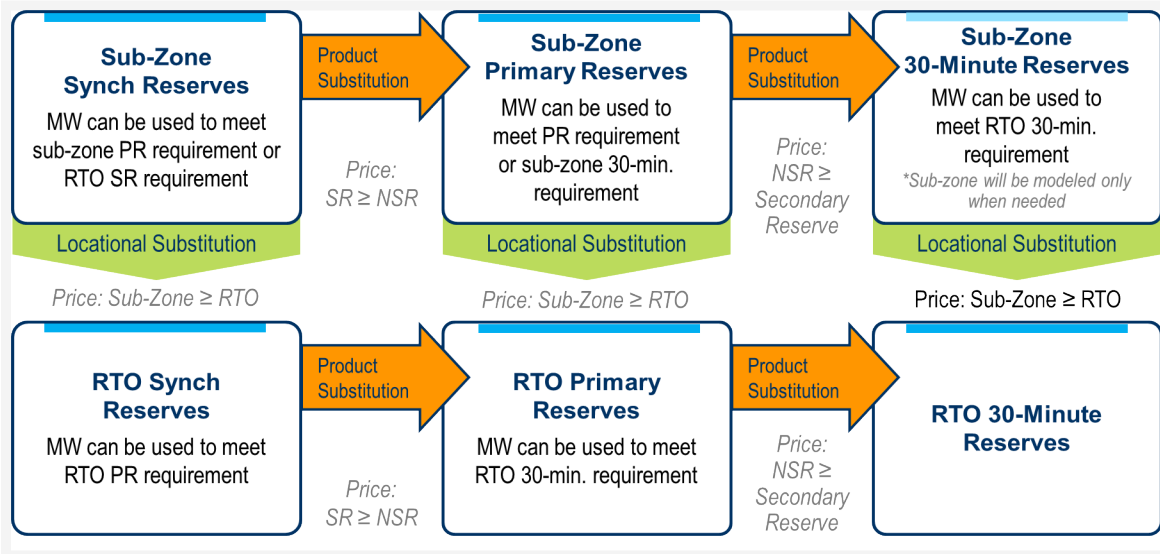

If,

Υ_{SR} : quantity of SR Product contributing to meet the SR, PR, and 30-Min requirements

Υ_{NSR} : quantity of NSR Product contributing to meet the PR and 30-Min requirements

Υ_{SecR} : quantity of SecR Product contributing to meet the 30-Min requirement

and SP: shadow price of the next MW of the product requirement constraint.

Then,

$$SRMCP = SPSR (\Upsilon_{SR}) + SPPR (\Upsilon_{SR}, \Upsilon_{NSR}) + SP30MIN(\Upsilon_{SR}, \Upsilon_{NSR}, \Upsilon_{SecR})$$

$$NSRMCP = SPPR (\Upsilon_{SR}, \Upsilon_{NSR}) + SP30MIN(\Upsilon_{SR}, \Upsilon_{NSR}, \Upsilon_{SecR})$$

$SecRMCP = SP30MIN(\Upsilon SR, \Upsilon NSR, \Upsilon SecR)$

The above MCPs are representatives of a cascading model for reserve prices. That is, the Synchronized Reserve Market Clearing Price (SRMCP) reflects the contribution that SR resources make to satisfy the SR, PR, and 30-minute requirements. Similarly, the Non-Synchronized Reserve Market Clearing Price (NSRMCP) reflects the contribution that NSR resources make to satisfy the PR and 30-minute requirements, and finally, the Secondary Reserve Market Clearing Price (SecRMCP) reflects the contribution that SecR resources make to satisfy the 30-Min requirement.

The reserve clearing prices will be capped during a normal condition and during reserve shortage as detailed in Section 4.4.5.

4.4.2 Day-ahead Reserve Market Clearing

The Day-ahead Reserve Market clearing results in an hourly price for Synchronized Reserves, Non-Synchronized Reserves, and Secondary Reserves for the next day, and is posted along with the resource-specific reserve assignments from the dispatch run by 13:30 EPT via the PJM Markets Gateway System.

The hourly Reserve Clearing Prices are fixed once calculated and posted by 13:30 EPT the day before the Operating Day. The hourly Reserve clearing prices are based upon the offer prices submitted by the selected resources, together with the summation of the applicable product shadow prices in the Day-ahead joint-optimization process, from the pricing run.

4.4.3 Real-time Reserve Market Clearing

Sixty (60) minutes prior to the operating hour PJM executes the Ancillary Services Optimizer (ASO). The ASO jointly optimizes Energy, Synchronized Reserves, Non-Synchronized Reserves, Secondary Reserves, and Regulation based on forecast system conditions to determine an economic set of inflexible reserve resources to commit for the operating hour. Inflexible resources are defined as those resources that physically require an hourly commitment due to minimum run time constraints or staffing constraints. Inflexible resources include:

- Synchronous condensers that are operating in condensing mode solely for the purpose of providing Synchronized Reserves
- Energy Storage resources enrolled in the ESR participation model (unless the resource has elected to be flexible)
- Economic Load Response that are prepared to curtail in response to a PJM Reserve Event (unless the resource has elected to be flexible)

Any inflexible self-scheduled offers for Synchronized Reserves that are available at the time of the ASO execution are assumed valid and committed for the hour.

Any reserve commitments on inflexible resources that are made are locked for the operating hour and communicated via Markets Gateway.

- Condensers and Inflexible Economic Load Response resources that are cleared Day-ahead will have their commitments carried to Real-time
 - These resources need to have a min run time (min down time for ELR resources) no greater than one hour and notification time between ten and thirty minutes.
 - The reserve commitment is carried over unless in Real-time the resource is committed to provide energy or another ancillary product

The following reserve information will be posted to Markets Gateway thirty (30) minutes prior to the operating hour from the approved ASO case:

- Preliminary Reserve Requirements for the RTO and active Sub-Zone.
- Total projected Reserve MW transferrable from the RTO into the active Sub-Zone.
- Total preliminary assigned reserve MWs for the RTO and active Sub-Zone.
- Total preliminary self-scheduled Reserves for the RTO and active Sub-Zone.
- Forecasted reserve deficit MW quantities for the RTO and active Sub-Zone.

The following resource specific reserve information will be posted to Markets Gateway thirty (30) minutes prior to the operating hour from the approved ASO case:

- Reserve Offer MW for the applicable product
- Inflexible Reserve Awarded MW for the applicable product
- Inflexible Synchronized Reserve Self-scheduled MW

Additional Real-time Reserve commitments may be made on flexible reserve resources by the RT SCED application and additional inflexible reserves resources recommendations by the IT SCED application. Commitments on flexible reserves resources may change with each execution of the RT SCED application while commitments on inflexible reserve resources will respect the minimum run time of those resources. PJM Operator, if necessary, may manually request an inflexible resource previously committed for reserves to provide energy. Such reasons include but are not limited to constraint control. Such action will automatically terminate the resource's reserve assignment.

- Flexible reserve resource commitments will not be posted to Markets Gateway but will be telemetered via ICCP or other communication protocol to resource owners.
- Additional inflexible resource commitments will be communicated to the resource owners via ICCP or other communication protocol.

PJM utilizes resource specific offers together with energy offers and resource schedules from the Markets Gateway System, as input data to the Ancillary Service Optimizer (ASO). ASO then optimizes the RTO dispatch profile and forecasts LMPs to determine hourly commitments for inflexible resources.

Although the ASO considers all available resources during its commitment process, the hourly commitments for Reserves from the ASO are limited to inflexible resources only and may only represent a portion of PJM's Reserve needs for the hour.

IT SCED has the ability to project conditions further out into the future and make a recommendation to commit additional inflexible resources for reserves where they are economic.

The Real-time Security Constrained Economic Dispatch (RT SCED) program jointly optimizes the remaining RTO Reserve needs simultaneously with Energy while honoring effective regulation assignments. For more information on how RT SCED uses Reserve commitments in the joint optimization, please refer to Section 2.5 of this Manual. The Locational Pricing Calculator (LPC) calculates a clearing price for Reserve every five (5) minutes as described in Section 2.7 of this Manual. Five (5) minute, Real-time, Synchronized Reserve Market Clearing Prices (SRMCP), Non-Synchronized Reserve Market Clearing Prices (NSRMCP), and Secondary Reserve Market Clearing Prices (SecRMCP) are used for market settlement.

During each execution of RT SCED, additional Reserve MWs may be committed to meet the Reserve Requirements from flexible resources for all services based on forecasted system conditions by re-dispatching online generating resources. In addition, RT SCED will commit offline resources to meet the balance of the Primary Reserve Requirement and 30-minute Reserve Requirement.

PJM may call on resources not otherwise scheduled to run in order to provide Reserves, in accordance with PJM's obligation to maintain reliability. If a resource is called on by PJM for the purpose of providing Reserves, the resource is guaranteed recovery of applicable Reserve lost opportunity costs as well as start up, no-load and energy costs. Please refer to PJM Manual 28: Operating Agreement Accounting for additional settlements details.

The Real-time Market Reserve clearing prices are set based upon the offer prices submitted by the selected resources, together with the summation of the applicable product shadow prices in the joint-optimization process from the pricing run.

Resources cannot clear the Real-time Reserve and Regulation Markets for the same interval. The requirement for regulation is first met before reserves because regulation is a higher priority service.

4.4.3.1 Deselection of Reserve Resources in Real-time

Under certain operating conditions, resources cannot reliably provide reserves. These resources are automatically deselected from reserve commitment consideration during the period they are logged for reasons that include but are not limited to:

- Regulation Service
- Testing

- Released / Tripped / Cancelled / Failed to Start
- Startup Mode

To accurately account for reserves, PJM may temporarily deselect a resource from being considered for reserve commitment in the next interval and if necessary de-assign a current reserve commitment for reasons that include but are not limited to the following:

- Resource is not following its dispatch signal
 - Resources that cannot reliably be counted towards providing reserves and are deselected from providing reserves due to failure to respond to PJM's dispatch signals will be in violation of the reserve must offer requirement. Market Sellers should update their Offer Data as practical and timely as possible to reflect any limitation in their capability to provide energy or reserves. This includes updating their economic minimum, economic maximum, ramp rates, and offer MW if applicable.
- Resource owner has indicated via telemetry or phone call to PJM Dispatch that a resource is not available due to a physical limitation of the unit or at the plant
 - Any Market Seller that believes its generating unit has operating modes, limits, or conditions where the unit would not be capable of providing Synchronized and/or Secondary Reserves in real time, can submit to PJM and the MMU a request for an exception from being assigned Synchronized and/or Secondary Reserves in the Real-time Reserve Markets during time periods in which the generating unit is in those operating modes, limits, or conditions. The request must be submitted to Reserves@pjm.com.
 - As part of the request, the Market Seller shall supply, for each generating unit, technical information about the operational modes, limits, or conditions to support the requested exception. Only actual physical operational limitations, environmental limitations and other actual constraints on a resource will be considered for an exception. The following list is not an exhaustive list, but provides examples of the types of information and documentation PJM would request:
 - Original Equipment Manufacturer (OEM) documentation
 - Control room data
 - Operational procedure listing the required steps along with the time required to perform each step during ramping.
 - PJM shall consult with the MMU, and consider any input received from the MMU, in its determination of a request for such an exception. Within 60 days of the submission of the request, PJM shall notify the Market Seller in writing, with a copy to the MMU, whether the request is approved or denied. The effective date of any approved request will be provided in the written notification.
 - If a Market Seller has an approved exception, the Market Seller must communicate via telemetry primarily (or via phone calls when telemetry is not available) to PJM when the unit cannot provide reserves.

- An approved exception will remain applicable to the unit until such time as PJM determines that a change is needed or the Market Seller notifies PJM, with a copy to the MMU, that a change is needed based on changed operational capabilities of the unit. Market Sellers must notify PJM, with a copy to the MMU, within 30 days of any changed operational capabilities that necessitate a change in an approved exception.

4.4.4 Opportunity Costs for Condensers in the Reserve Clearing

Estimated resource opportunity cost for condensing CTs is calculated, based on the dispatch run, as follows:

$$O.C. = \text{[positive (forecast LMP - energy offer price)]} \times \text{MW capability} / \text{synchronized reserve capability}$$

Estimated resource opportunity cost for non-condensing resources is calculated, based on the dispatch run, as follows:

$$O.C. = | \text{LMP} - \text{ED} | \times \text{GENOFF}$$

Where:

LMP	is the forecasted hourly LMP at the generator bus,
ED	is the price associated with the set point the resource must maintain to provide its assigned amount of Synchronized Reserve, and
GENOFF	is the MW amount of Synchronized Reserve provided.

This formula is somewhat simplistic. The actual calculation is an integration that may be visualized as the area on a graph enclosed by the resource's energy offer curve. The points on that curve correspond to the resource's desired economic dispatch and the set point necessary to provide the assigned amount of Reserve and the LMP.

Condense Energy Use for each condensing resource is entered in MW by the owner via the Markets Gateway system as part of the Reserve Offer. Estimated energy use is calculated as part of the merit order price as follows:

$$E.U. = \text{forecasted LMP} \times \text{Condense Energy Use} / \text{synchronized reserve capability}$$

For each of these calculations, forecast LMP is the result of the 1-hour look-ahead calculated in the ASO. In the after-the-fact settlement, the Real-time LMP is used.

Energy resources for which an energy offer is not submitted will be ineligible for opportunity cost credit.

When calculating the reserve MCP in Real-time, only the offer prices submitted by flexible resources, together with the summation of the applicable products shadow prices in the joint-

optimization process from the pricing run are considered. The actual five-minute reserve MCP, calculated using the LPC pricing run, is used for settlements.

Hydropower units condensing to provide Reserves during times when they were not scheduled to operate incur no opportunity cost. There may or may not be an energy use component, as indicated by the owner as part of the Reserve Offer. Only hydropower units not enrolled in the ESR participation model are considered in the rules below.

- If a hydropower unit is held to condense for reserves or reduced to provide reserves during a time when it is scheduled to generate, it will incur opportunity cost. Since hydropower units operate on a schedule and do not have an energy bid, opportunity cost for these units is calculated as follows:
 - The formula is the same as that shown under ‘Reserve Commitment’,
 - $O.C. = |LMP - ED| \times GENOFF$
 - Except:
 - the ED value is the average value of the LMP at the hydropower unit bus for the appropriate on-peak (07:00 – 22:59) or off-peak (00:00 – 06:59, 23:00 – 23:59) period, excluding those hours during which all available units at the hydropower plant were operating.
 - Day-ahead values are used for the purposes of committing reserve resources, and actual LMPs are used in the after-the-fact settlement.
 - If the average LMP value is higher than the actual LMP at the generator bus, the opportunity cost is zero.
- During those hours when a hydropower unit is in spilling mode, the ED value is set to zero such that the opportunity cost is based on the full value of LMP. During the operating day, the operating company is responsible for communicating this condition on the Regulation Hourly Updates page in the Markets Gateway System.
- When determined to be economically beneficial, PJM maintains the authority to adjust hydropower unit schedules for those units scheduled by the owner if the owner has also submitted a Synchronized Reserve Offer for those units and made the units available for spin.
- An example of the reserve lost opportunity cost calculation is very similar to that of the regulation hydropower lost opportunity cost calculation detailed on the PJM website at <https://pjm.com/-/media/markets-ops/ancillary/regulation-uplift-and-lost-opportunity-cost.ashx>.

4.4.5 Determination of Reserve Clearing Prices

PJM clears the Reserve markets based on the locational Reserve Requirements and calculates clearing prices for the RTO and active subzone where applicable. Whenever the locational reserve constraint is not binding, the clearing prices are equal for each category of the reserve products. However, when more Reserves are required in a given location than would have been assigned without this requirement, the clearing prices will separate.

Resources will be identified and receive the applicable clearing price based on their location with respect to the binding constraint(s). That is, resources for which reserve event response would help the constraint will receive the higher clearing price, whereas resources for which reserve event response would aggravate the constraint will receive the lower clearing price.

Day-ahead prices for Synchronized Reserves, Non-Synchronized Reserves, and Secondary Reserves are calculated simultaneously with Energy every hour, in the pricing run of the Day-ahead joint-optimization process.

Real-time prices for Synchronized Reserves, Non-Synchronized Reserves, and Secondary Reserves are calculated simultaneously with Energy, and Regulation, every five (5) minutes by LPC, in the pricing run, as described in Section 2.7 of this Manual.

The prices for Synchronized Reserves, Non-Synchronized Reserves, and Secondary Reserves will be calculated as the marginal cost to serve an additional MW of applicable reserve product in the RTO Reserve Zone and applicable active Reserve Sub-Zone while simultaneously satisfying energy requirements, regulation requirements, synchronized reserve requirement, primary reserve requirements, 30-minute reserve requirements, and transmission limitations.

The hourly Day-ahead Reserve clearing prices from the pricing run are fixed once calculated and posted in Markets Gateway and Data Miner with the Day-ahead results by 13:30 EPT the day before the Operating Day.

Preliminary Real-time five (5) minute SRMCPs, NSRMCPs, and SecRMCPs from the pricing run will be published to Data Miner for public view. The procedure for finalizing the Real-time MCPs along with LMPs is described in Section 2.10 of this manual.

During periods when there is no reserve shortage, prices for Reserves will be determined by the cost of the applicable marginal reserve resource of the product type as described in Section 4.4.1.

The maximum reserve prices are capped as follows:

- Synchronized Reserves are capped at two times the penalty factor (\$1,700)
- Non-Synchronized Reserves are capped at one and a half times the penalty factor (\$1,275)
- Secondary Reserves are capped at one times the penalty factor (\$850)

4.4.5.1 Determination of Synchronized Reserve Clearing Prices

During periods when there is no Synchronized Reserve Shortage, the Synchronized Reserve Market Clearing Price (SRMCP) is the cost of the Marginal Synchronized Reserve resource. During periods when there is a shortage of Synchronized Reserves, the SRMCP will be greater than or equal to the penalty factor of the location where the shortage occurred.

The SRMCP will always be greater than or equal to the Non-Synchronized Reserve Market Clearing Price (NSRMCP) in the same location because Synchronized Reserve is a higher quality product than Non-Synchronized Reserves and may be substituted for it. Similarly, the NSRMCP will always be greater than or equal to the Secondary Reserve Market Clearing Price (SecRMCP) in the same location because Non-Synchronized Reserve is a higher quality product than Secondary Reserves and may be substituted for it as referenced in Section 4.4.1.

The price for each reserve product will not exceed the greater of the price cap for the reserve product or the sum of the penalty factor and the prices for the lower quality reserve products for the same location.

The Day-ahead hourly SRMCPs and Real-time five (5) minute SRMCPs from the pricing run are used for market settlement purposes.

Resources that are assigned Synchronized Reserves will be paid the SRMCP corresponding to the location in which they provided the service.

4.4.5.2 Determination of Non-Synchronized Reserve Clearing Prices

During periods when there is no Primary Reserve Shortage, the Non-Synchronized Reserve Market Clearing Price (NSRMCP) is the cost of the Marginal Primary Reserve Resource as described in Section 4.4.1. If the marginal resource is a Synchronized Reserve Resource, the NSRMCP will be the same as SRMCP.

During periods when there is a shortage of Primary Reserves, the NSRMCP will be greater than or equal to the penalty factor of the location where the shortage occurred.

The NSRMCP will always be less than or equal to the SRMCP in the same location because Synchronized Reserve is a higher quality product than Non-Synchronized Reserve and may be substituted for it.

The Day-ahead hourly NSRMCPs and Real-time five (5) minute NSRMCPs from the pricing run are used for market settlement purposes.

Resources that are assigned Non-Synchronized Reserves will be paid the NSRMCP corresponding to the location in which they provided the service.

4.4.5.3 Determination of Secondary Reserve Clearing Prices

During periods when there is no 30-minute Reserve Shortage, the Secondary Reserve Market Clearing Price (SecRMCP) is the cost of the Marginal 30-minute Reserve Resource as described in Section 4.4.1.

During periods when there is a shortage of 30-minute Reserves, the SecRMCP will be equal to the penalty factor of the location where the shortage occurred.

The SecRMCP will always be less than or equal to the SRMCP and NSRMCP in the same location because Synchronized Reserve and Non-Synchronized Reserve are higher quality products than Secondary Reserve and may be substituted for it.

The hourly Day-ahead SecRMCPs and Real-time five (5) minute SecRMCPs from the pricing run are used for market settlement purposes.

Resources that are assigned 30-minute Reserves will be paid the SecRMCP corresponding to the location in which they provided the service.

4.5 Event Performance

During a Reserve Event, PJM may request generation resources, which are assigned in real-time to provide Reserves, to increase their energy output. Any resource that is committed for Synchronized Reserves when a Synchronized Reserve Event occurs is obligated to respond to the PJM's instructions at the start of the event within ten (10) minutes.

4.5.1 Performance Verification

The magnitude of each resource's response to an event is dependent on the type of event called.

- For Synchronized Reserve Events:
 - The magnitude of each resource's response is the difference between the resource's output at the start of the event and its output ten (10) minutes after the start of the event.
 - In order to allow for small fluctuations and possible telemetry delays, resource output at the start of the event is defined as the lowest telemetered output between one (1) minute prior to and one (1) minute following the start of the event.
 - Similarly, a resource's output ten (10) minutes after the event is defined as the greatest output achieved between nine (9) and eleven (11) minutes after the start of the event.
 - For Economic Load Response considered "batch load" resources, a second method of verification will be used for instances where a Synchronized Reserve Event is initiated and the resource is operating at the minimum consumption level of its duty cycle. In this case, the magnitude of the response will be measured as the difference between (a) the resource's consumption at the end of the event and (b) the maximum consumption within a ten (10) minute period following the event provided that all subsequent minutes following that minute are no less than 50% of the consumption in that minute.
- For Non-Synchronized Reserve Events: The magnitude of each generation resource's response is its output ten (10) minutes after the start of the event. A generation resource's

output ten (10) minutes after the event is defined as the greatest output achieved between nine (9) and eleven (11) minutes after the start of the event.

- All resources must maintain an output level greater than or equal to that which was achieved as of ten (10) minutes after the event for the duration of the event or thirty (30) minutes from the start of the event, whichever is shorter.
 - The response actually credited to a given resource will be reduced by the amount the MW output of that resource falls below the level achieved after ten (10) minutes by either the end of the event or after thirty (30) minutes from the start of the event, whichever is shorter.
- In cases where an event lasts less than ten (10) minutes, resources are credited with the amount of reserve capacity they are assigned.
- An offline generation resource assigned to provide Secondary Reserve in Real-time that is subsequently dispatched by PJM to provide Energy during that Operating Day is required to come online and reach Economic Minimum output within 30 minutes.
- An Economic Load Response resource assigned to provide Secondary Reserve in Real-time that is subsequently dispatched by PJM to provide Energy as a load reduction during that Operating Day is required to reduce load by at least the Economic Minimum within 30 minutes.
 - An Economic Load Response resource's starting MW usage is the greatest telemetered consumption between one minute prior to and one minute following the dispatch instruction, and the ending MW usage shall be the lowest consumption between 29 and 31 minutes after the dispatch instruction.
 - For Batch Load Economic Load Response Participant Resources, a second method of verification will be used for instances where a Secondary Reserve assignment dispatched as an energy load reduction is initiated and the resource is operating at the minimum consumption level of its duty cycle. In this case, the magnitude of the response will be measured as the difference between (A) the minimum of the resource's consumption between the minute before and the minute after the end of the last settlement interval the resource reduced load and (B) the maximum consumption within a ten (10) minute period following the end of the last settlement interval the resource reduced load provided that all subsequent minutes following that minute are no less than 50% of the consumption in that minute.

4.5.2 Non-Performance

All resources are credited with a capacity payment any time they are expected to be ready to respond to a Synchronized Reserve Event and failure to provide the directed response results in an obligation to "repay" that credit following instances of non-performance. The following consequences exist for a resource that does not respond with its expected amount of Synchronized Reserve:

- The resource is credited for Synchronized Reserve capacity in the amount that actually responded for all Real-time settlement intervals (five (5) minutes) the resource was assigned or self-scheduled Synchronized Reserve on the day the event occurred, and;
- The owner of the resource incurs a retroactive obligation to refund at the SRMCP the amount of the shortfall measured in MW for all of the Real-time settlement intervals the resource was assigned or self-scheduled over the immediate past interval, the duration of which is equal to the lesser of the average number of days between events as determined by the annual review of the last two (2) years, or the number of days since the resource failed to respond with its assigned or self-scheduled Synchronized Reserve amount in response to a Synchronized Reserve Event.
 - The annual review described above will be completed during the month of November and cover a two (2) year window from November 1st (year – 2) through October 31st (current year). The calculation will be the average interval between Synchronized Reserve Events over the last two years of Synchronized Reserve Event data, rounded down to a whole day value. The results will be communicated to the Operating Committee in December and implemented annually on January 1st.

In cases where a Synchronized Reserve Event lasts less than ten (10) minutes, resources are credited with the amount of Synchronized Reserve capacity they are assigned. The owner of the resource will not incur a retroactive obligation to refund any shortfall between the amount of reserve assigned or self-scheduled and the amount of response provided during the event.

Resources that choose to respond to a Synchronized Reserve Event for their reserve zone in an hour when they are cleared or assigned regulation are expected to return to their regulating band within ten (10) minutes of the end of the Synchronized Reserve Event. From the start of the event, through the event, and for the ten (10) minutes after the end of the event, the performance scores for all regulating resources in the reserve zone where the Synchronized Reserve Event takes place will be null.

In the event a resource that has been assigned to provide Non-Synchronized Reserves fails to provide the assigned amount of Non-Synchronized Reserves in response to a Non-Synchronized Reserve Event, the resource will only be credited for Non-Synchronized Reserve capacity in the amount that actually responded for the continuous five (5) minute intervals the resource was assigned Non-Synchronized Reserves during which the event occurred.

Resources assigned to provide Secondary Reserve in Real-time that are subsequently dispatched by PJM to provide Energy during that Operating Day but do not meet their obligation are required to buy back the Day-ahead assignment at the Real-time Secondary Reserve Market Clearing Price, or if solely assigned in Real-time not being paid for the assigned MW.

- For each generation resource that fails to come online and reach Economic Minimum output within 30 minutes as instructed by PJM the resource's Real-time Secondary Reserve assignment will be set to zero megawatts for that interval and for all prior intervals in which the resource was assigned to provide Secondary Reserve in the Real-time

Secondary Reserve Market starting at the later of (A) the last interval the resource was online or (B) the beginning of that Operating Day and continuing up to the interval the resource failed to come online.

- For each Economic Load Response Participant resource that fails to reduce load by at least the Economic Minimum within 30 minutes as instructed by PJM, the resource's Real-time Secondary Reserve assignment will be set to zero megawatts for that interval, and for all prior intervals in which the resource was assigned to provide Secondary Reserve in the Real-time Secondary Reserve Market between such non-performance event starting at the later of (A) the last interval the resource reduced load at the instruction of PJM or (B) the beginning of that Operating Day, and for all subsequent intervals through the earlier of (C) the next interval in which the resource is dispatched to reduce load or (D) the end of the Operating Day.

4.6 Reserve Obligations

Each Load Serving Entity (LSE) on the PJM system incurs a Synchronized Reserve Obligation, Non-Synchronized Reserve Obligation, and Secondary Reserve Obligation in kWh based on their Real-time load ratio share and the total MW assigned to meet each applicable requirement.

- Participants can estimate their share of the PJM Synchronized Reserve Requirement, PJM Primary Reserve Requirement, and 30-Minute Reserve Requirement in advance by comparing their hourly load forecast to the PJM hourly load forecasts provided by PJM.
- When the respective Reserve Market Clearing Price (SRMCP, NSRMCP, or SecRMCP) is the same throughout the Reserve Zone or active Reserve Sub-zone, an LSE's respective Reserve Obligation is equal to its obligation load ratio share times the amount of respective Reserve assigned for the Reserve Zone or active Reserve Sub-zone as applicable.
- When congestion causes the respective Reserve Market Clearing Prices (SRMCP, NSRMCP, or SecRMCP) to separate, each LSE's obligation is equal to its obligation load ratio share within the Reserve Zone or active Reserve Sub-zone times the amount of respective Reserve MW assigned in the applicable Reserve Zone or active Reserve Sub-zone.
- Participant may fulfill their respective Reserve Obligations by:
 - Self-scheduling from its own generation resources capable of providing the respective Reserves;
 - Entering bilateral arrangements with other market participants as described in Section 4.7 of this Manual; or
 - Purchasing the applicable Reserves quantity from the market.

4.7 Bilateral Reserve Transactions

PJM Settlement shall be the Counterparty to the purchases and sales of Synchronized Reserve, Non-Synchronized Reserves, and Secondary Reserves.

Bilateral Reserve Transactions may be reported to PJM for Synchronized Reserves, Non-Synchronized Reserves and Secondary Reserves. Such reported Bilateral Reserve Transactions must be for the physical transfer of category of Reserves and must be reported by the buyer and subsequently confirmed by the seller through the Markets Gateway System no later than 13:30 the day after the transaction starts. Bilateral transactions that have been reported and confirmed may not be changed; they must be deleted and re-reported. Deletion of a reported bilateral transaction after its start time has passed will result in a change in the end time of the transaction to the current hour.

Bilateral Reserve Transactions reported to PJM may be entered either in MW (minimum MW amount is 0.1 MW). There are separate transaction types based on the product being transferred. Participants are also required to indicate the Reserve Zone or Sub-Zone for which the transaction is applicable.

Payments and related charges associated with the Bilateral Reserve Transactions reported to PJM shall be arranged between the parties to the bilateral contract.

A buyer under a Bilateral Reserve Transaction reported to PJM agrees that it guarantees and indemnifies PJM, PJM Settlements, and the Market Participants for the costs of any purchases by the seller in the Synchronized, Non-Synchronized, or Secondary Reserve Markets, as determined by PJM, to supply the reported bilateral transaction and for which payment is not made to PJM Settlement by the seller.

Upon any default in obligations to PJM or PJM Settlements by a Market Participant, PJM shall not accept any new bilateral reporting by the Market Participant and shall terminate all of the Market Participant's reporting of Markets Gateway schedules associated with its Bilateral Reserve Transactions previously reported to PJM for all days where delivery had not yet occurred.

PJM calculates and posts Synchronized Reserve, Non-Synchronized Reserve, and Secondary Reserve preliminary billing data which Market Participants can use as a resource for pricing Bilateral Reserve Transactions.

The data can be found via PJM's Data Miner 2 Tool.

4.8 Reserve Settlements

PJM Reserve settlements are a zero-sum calculation based on the Reserves provided to the market by Market Sellers and purchased from the market by Market Buyers.



Please refer to PJM Manual 28: Operating Agreement Accounting for settlement details.

Section 4b: Section Retired

4b.1 Section Retired

4b.2 Section Retired

Section 5: Market Clearing Processes and Tools

Welcome to the Market Clearing Processes and Tools section of the PJM Manual for Energy & Ancillary Services Market Operations. In this section you will find the following information:

- A description of the PJM scheduling process (see “PJM Scheduling Process”).
- A description of the tools that are used during the scheduling process (see “Scheduling Tools”).

5.1 PJM Scheduling Process

The PJM scheduling objective varies depending on the scheduling time horizon (Day-ahead, Reliability Assessment and Commitment (RAC) Run, Real-time Operations). The PJM scheduling process in the Day-ahead Energy Market is to schedule generation to meet the aggregate Demand bids that result in the least-priced generation mix, while maintaining the reliability of the PJM RTO. During the RAC Run, PJM schedules additional resources as needed to satisfy the PJM Load Forecast and the Operating Reserve objective based on minimizing the scheduling cost.

PJM also schedules resources based on economics to control potential transmission limitations that are binding in the Transmission Reliability analysis that is performed in parallel with and subsequent to the Day-ahead Market analysis. The scheduling process evaluates the price of each available resource compared with every other available generating resource. The process for scheduling the PJM RTO requires:

- In the Day-ahead Energy Market:
 - Scheduling sufficient generation to cover aggregate demand bids and Day-ahead Reserve requirements calculated as a function of such demand bids.
- In the Reliability Assessment and Commitment (RAC) Run (subsequent to the Day-ahead Energy Market):
 - Scheduling sufficient generation to cover the PJM Load Forecast and Operating Reserve requirements.
- In Real-time Operations:
 - Scheduling sufficient generation to control potential transmission limitations that are binding in the Transmission Reliability analysis.
 - Scheduling sufficient generation to satisfy the PJM Regulation Requirement, PJM Primary Reserve Requirement, and other ancillary service requirements of the PJM RTO.
 - Ensuring PJM Members participate in the analysis and elimination of conditions that threaten the reliable operation of the PJM RTO.

- Exhibit 7 illustrates the Real-time Market scheduling relationships in the form of a bar chart.

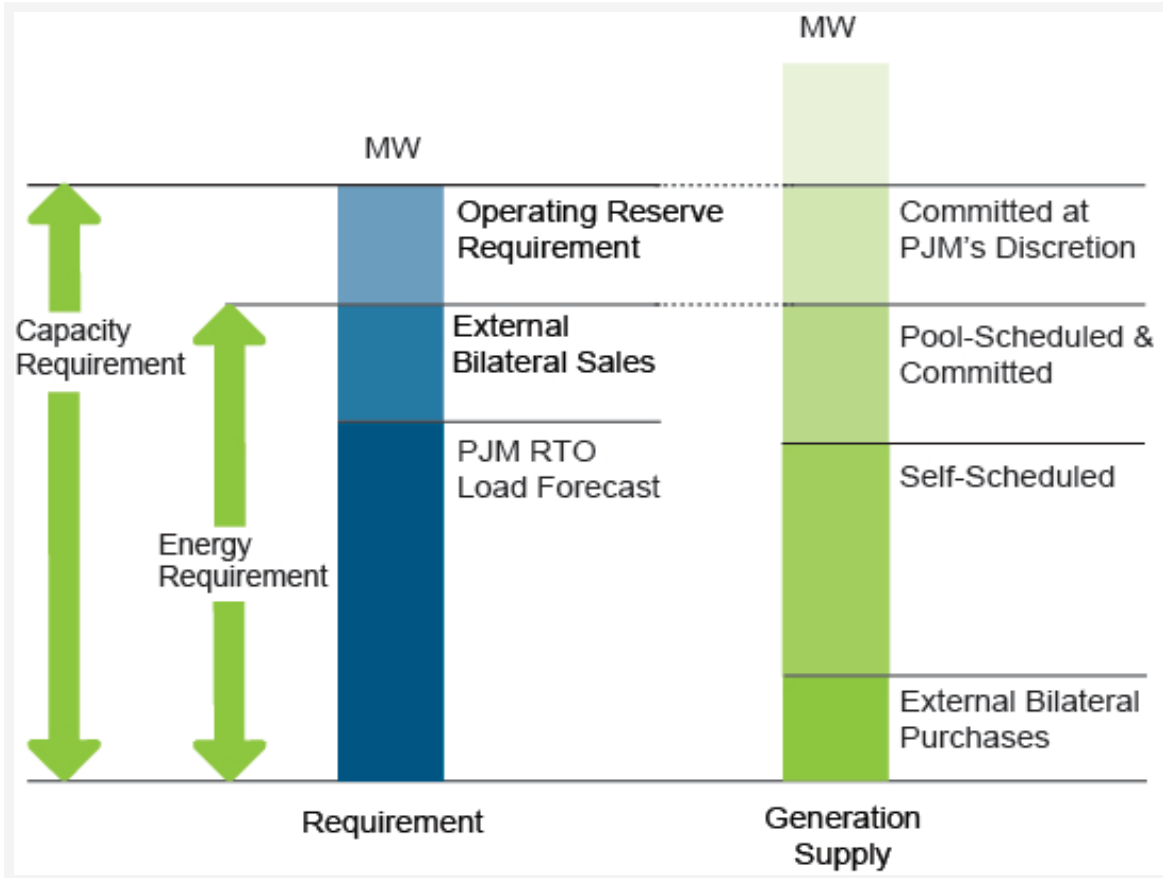

Requirement vs. Resource Supply

The exhibit above presents the following information:

- The PJM requirement is represented by the bar on the left. The height of this bar is the total PJM Capacity requirement in MW. The Capacity requirement consists of two components:
 - Energy requirement, consisting of the PJM Load Forecast plus External Transaction sales to External Control Areas.
 - **Day-ahead Reserve requirements.**
- The PJM resource supply is represented by the bar on the right which consists of four supply components:
 - External Transaction purchases from External Control Areas.
 - Resources that are self-scheduled by the PJM Members.

- Resources and capacity that are bid into the Day-ahead Market and the Real-time Market and are scheduled by PJM to meet the energy and reserve requirement.
- Additional capacity to satisfy the **Day-ahead Reserve requirements** is committed at the discretion of the PJM.

Scheduling of resources by PJM is performed economically on the basis of the prices and operating characteristics offered by the Market Sellers, using security constrained economic dispatch and continuing until sufficient generation is dispatched in each five minute interval to serve all energy purchase requirements, as well as the PJM RTO requirements.

5.2 Scheduling Tools

Analytical scheduling tools exist to assist PJM with the scheduling process. These tools permit PJM scheduling staff to analyze numerous scheduling scenarios. PJM personnel use several tools to assist in scheduling the resources for short-term and hourly activities. The scheduling tools include:

- PJM ExSchedule
- PJM InSchedule
- Load Forecasting Algorithms
- Markets Gateway
- Market Database System
- Hydro Calculator
- Energy Market Technical Software (RSC, SPD and SFT)
- PJM Ancillary Service Optimizer (ASO)
- Real-time Market Clearing Engines

Together these tools recognize the following conditions:

- Reactive Limits
- Resource Constraints
- Unscheduled Power Flows
- Inter-area Transfer Limits
- Resource Distribution Factors
- Self-Scheduled Resources
- Limited Fuel Resources
- Bilateral Transactions
- Hydrological Constraints
- Generation Requirements
- Reserve Requirements

5.2.1 ExSchedule

ExSchedule is an application that facilitates the scheduling of interchange transactions between PJM and other Balancing Authorities. Market Participants can view and reserve a portion of PJM's Net Ramp capability, review Tags linked to their account, and submit Day-ahead Bids that align with their Real-time interchange transactions. ExSchedule is also used to automatically assess and validate bilateral interchange transactions per PJM's interchange scheduling business rules.

Bilateral interchange transactions that are reported to PJM must be for the physical transfer of electric energy. Payments and related charges associated with such bilateral interchange transactions reported to PJM shall be arranged between the parties to the bilateral transaction. A buyer under a bilateral interchange transaction reported to PJM agrees that it guarantees and indemnifies PJM, PJM Settlement, and the Market Participants for the costs of any Spot Market Backup, as determined by PJM, to supply the reported bilateral interchange transaction and for which payment is not made to PJM Settlement by the seller.

Upon any default in obligations to PJM or PJM Settlement by a Market Participant, PJM shall not accept any new bilateral interchange transaction reporting by the Market Participant and shall terminate all of the Market Participant's reporting of associated bilateral interchange transactions previously reported to PJM for all days where delivery had not yet occurred.

5.2.2 PJM InSchedule

PJM InSchedule is an Internet application that is used, among other functions, to report internal bilateral transactions.

5.2.3 Load Forecasting

PJM scheduling staff requires load forecasts for up to seven (7) days in the future. For each day, a 24-hour load shape is needed.

- The first step in developing a load forecast is to obtain the weather information for the time period. Weather information is provided to PJM at regular intervals by a contracted-for weather service. Additional weather data sources include the National Weather Service, vendor tools, LSE weather information, and existing local PJM RTO conditions.
- The forecast period is reviewed to determine any conditions that could affect the PJM RTO's load, including:
 - Day of week
 - Holidays
 - Special events
 - Daylight savings time changes
 - Internal participant load forecasts

Peak loads and load shapes are determined using a combination of neural net and pattern matching algorithms. PJM's final forecast is a weighted average of these models, with manual adjustments added if needed.

The load forecasts are input into the Real-time clearing engines and Reliability Assessment and Commitment (RAC) clearing program. PJM scheduling staff also posts these forecasts on the OASIS.

5.2.4 Markets Database System

The Markets Database System is a two-part system:

- The Markets Database stores the basic resource data supplied by the PJM Members, including operating limits and resource availability.
- The Markets Gateway Web-site provides the Internet-based user interface that allows Market Participants to submit generation offers, Economic Load Response offers, Demand bids, Increment Offers, Decrement bids, Regulation Offers and Synchronized Reserve Offers into the Markets Database.

The Markets Database is a very large database that contains information on each generating resource that operates as part of the PJM Energy Market, Economic Load Response information, Demand Information, Virtual Bids, Regulation Offers, Reserve Offers, Day-ahead Energy and Reserve Market Clearing Prices, Regulation Market Clearing Prices and Real-time Reserve Market Clearing Prices. A description of the Markets Database can be found in the [Markets Database Dictionary](#).

Market Participants may access the Markets Database by using the PJM Markets Gateway Web site via the Internet using manual entry or bulk upload/download via XML format.

Please refer to the Energy Market Daily Exhibit below:

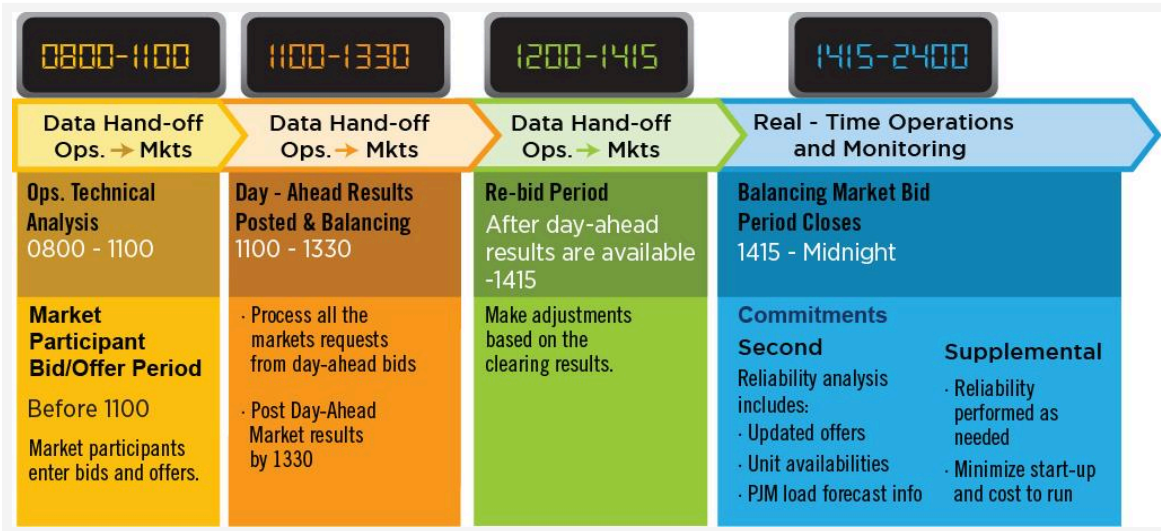

Exhibit 1: Energy Market Daily

- PJM clears the Real-time Reserve and Regulation markets on an hourly basis. The following is the timeline by which this hourly clearing is accomplished:
 - Sixty (60) minutes prior to the operating hour PJM executes the Ancillary Services Optimizer (ASO). The ASO jointly optimizes Energy, Synchronized Reserves, Non-Synchronized Reserves, Secondary Reserves and Regulation based on forecasted system conditions to determine an economic set of inflexible reserve resources to commit for the operating hour.

The data that needs to be submitted by PJM Members to participate in the Day-ahead Energy Real-time Energy, Reserve, and Regulation Markets is described in detail in the [Markets Database Dictionary](#).

5.2.5 Hydro Calculator

For PJM RTO Scheduled Hydropower Resources, PJM is responsible for developing the schedules for the run-of-river and pumped storage hydropower plants located within the PJM RTO and turned over to PJM for coordination. To assure hydraulic coordination of the hydropower plants, PJM uses a computer program called the Hydro Calculator. The Hydro Calculator computes hourly reservoir elevations and plant generation from input river flows and plant discharges. PJM scheduling staff uses the Hydro Calculator to concentrate on economic placement of available hydropower energy.

5.2.6 PJM Day-ahead Energy Market Technical Software

The PJM Energy Market Technical Software is a set of computer programs, which performs a security-constrained resource commitment and economic dispatch for the Day-ahead Market. The individual programs are:

- **Resource Scheduling & Commitment (RSC)** – RSC performs security-constrained resource commitment based on generation offers, Demand Resource offers, demand bids, Day-ahead Reserve offers, increment offers, decrement bids and transaction schedules submitted by participants and based on PJM RTO reliability requirements. RSC enforces physical resource specific constraints that are specified in the generation offer data and generic transmission constraints that are entered by the Market Operator. RSC provides an optimized economic resource commitment schedule for the next forty-eight (48) hours and it utilizes a mixed integer linear programming solver to create an initial resource dispatch for the next Operating Day.
- The objective of the commitment software (RSC) is to minimize the overall system production cost subject to various security and reliability constraints such as power balance constraints, transmission constraints, reserve requirement constraints, physical resource constraints, etc. This overall system production cost in RSC includes any penalty costs associated for violating security and reliability constraints.
- **Scheduling, Pricing & Dispatch (SPD)** – SPD performs security-constrained economic dispatch using the commitment profile produced by RSC. SPD calculates hourly resource generation MW levels, LMPs and Day-ahead Reserve Clearing Prices for all load and generation buses for each hour of the next Operating Day. SPD utilizes a linear programming solver to develop the economic dispatch solution while respecting generic transmission constraints that affect dispatch, such as reactive interface limits, and thermal limits.
- The objective of the dispatch software (SPD) is to minimize the overall system production cost subject to various security and reliability constraints such as power balance constraints, transmission constraints, reserve requirement constraints, physical resource constraints, etc. for a given commitment status of generation and economic demand response resources. This overall system production cost in SPD includes any penalty costs associated for violating security and reliability constraints.
- **Simultaneous Feasibility Test (SFT)** – SFT performs AC contingency analysis using a contingency list from the PJM Energy Management System (EMS) and creates generic constraint equations based on any violations that are detected. These generic constraint equations are then passed back to SPD for resolution. SFT ensures that the Day-ahead Market results are physically feasible considering PJM RTO security constraints and reliability requirements.

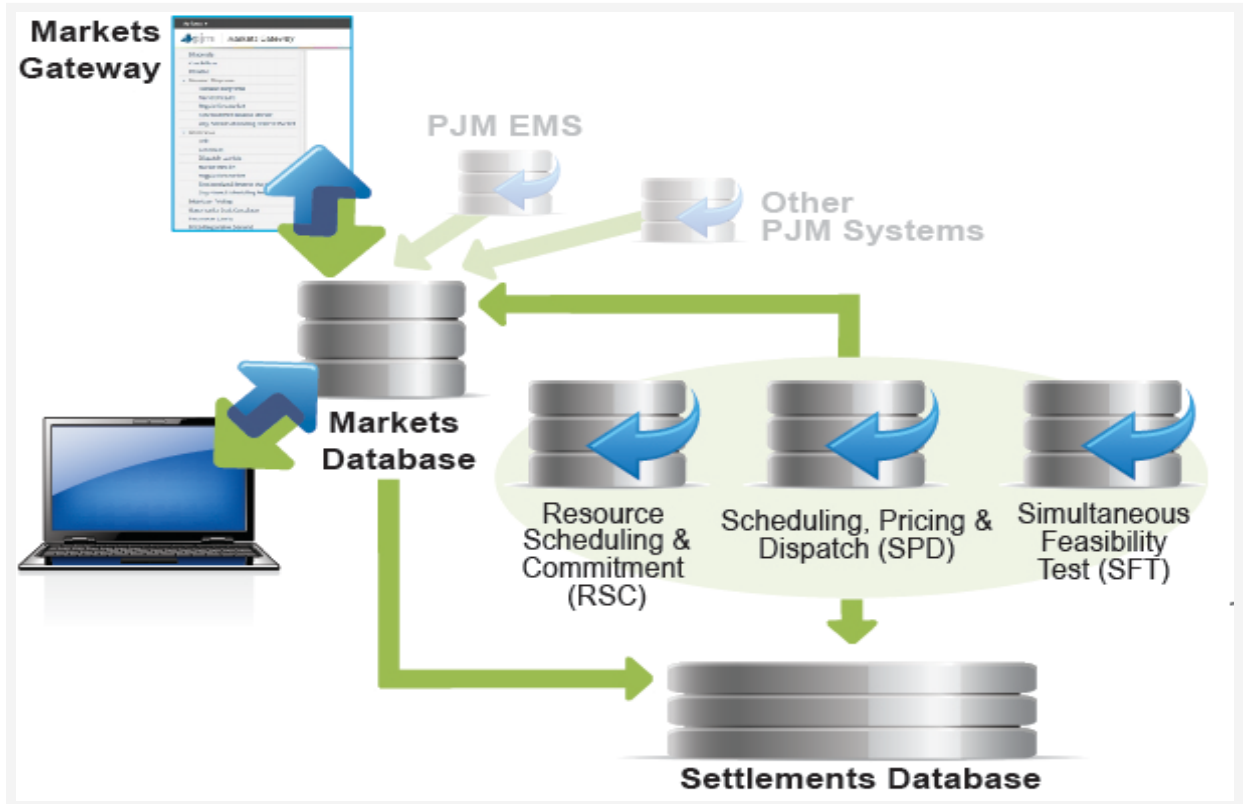

Exhibit 2: Settlement Subsystems

The Energy Market technical software develops the Day-ahead Market results based on minimizing production cost of energy and reserve to meet the demand bids and decrement bids that are submitted into the Day-ahead Market while respecting the PJM RTO security constraints and reliability requirements that are necessary for the reliable operation of the PJM RTO.

Subsequent to the close of the generation Re-bidding Period at 14:15, the RSC is the primary tool used to determine any change in steam resource commitment status based on minimizing the additional startup costs and costs to operate steam resources at economic minimum in order to provide sufficient operating reserves to satisfy the PJM Load Forecast (if greater than cleared total demand in the Day-ahead Market) and adjusted Day-ahead Reserve requirements.

The purpose of this second phase of resource commitment, known as the Reliability Assessment and Commitment (RAC) run, is to ensure that PJM has scheduled enough generation in advance to meet the PJM Load Forecast for the next Operating Day and for the subsequent day. Combustion Turbine (CT) resources are included in the scheduling process and are scheduled in the Day-ahead Market. However, the decisions concerning actual

operation of pool-scheduled CT resources during the Operating Day are not made until the current operating hour in Real-time dispatch.

5.2.7 Calculation of Day-ahead Prices

PJM's Day-ahead Energy Market uses security constrained economic dispatch optimization software to determine the least-cost means of procuring supply to meet demand and meet Day-ahead Reserve Requirements in the PJM Region. The Day-ahead Market includes offers for energy and reserves from generation, bids from fixed and price-sensitive load, increment offers, decrement bids, Up-to Congestion Transactions, offers for demand reductions, and interchange transactions. Day-ahead Locational Marginal Prices (LMPs) and reserve Market Clearing Prices (MCPs) are calculated for each hour, using the set of programs described in Section 5.2.6 of this Manual.

In performing this calculation, the Day-ahead Market shall calculate the cost of serving an increment of load at each bus from each eligible offer as the sum of the following components of Locational Marginal Price: (1) System Energy Price, which is the price at which the Market Seller has offered to supply an additional increment of energy from a resource, increment offers, import transactions, and/or has offered to decrease consumption by an Economic Load Response Participant resource, decrement bid, export transaction or price sensitive demand bid (2) Congestion Price, which is the effect on transmission congestion costs (whether positive or negative) associated with increasing the output of a generation resource or decreasing consumption by a Demand Resource, based on the effect of increased generation from the resource on transmission line loadings, and (3) Loss Price, which is the effect on transmission loss costs (whether positive or negative) associated with increasing the output of a generation resource or decreasing the consumption by a Demand Resource based on the effect of increased generation from or consumption by the resource on transmission line losses.

The offers that can serve an increment of load at a bus at the lowest cost, calculated in this manner, shall determine the Day-ahead Price at that bus for each hour. These LMPs and MCPs shall be the basis for purchases and sales of energy and transmission congestion charges resulting from the Day-ahead Energy Market.

Download Data from Markets Database

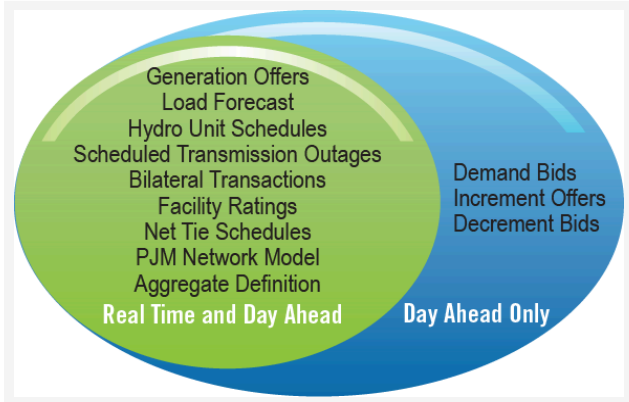

Exhibit 3: Download Data from Markets Database

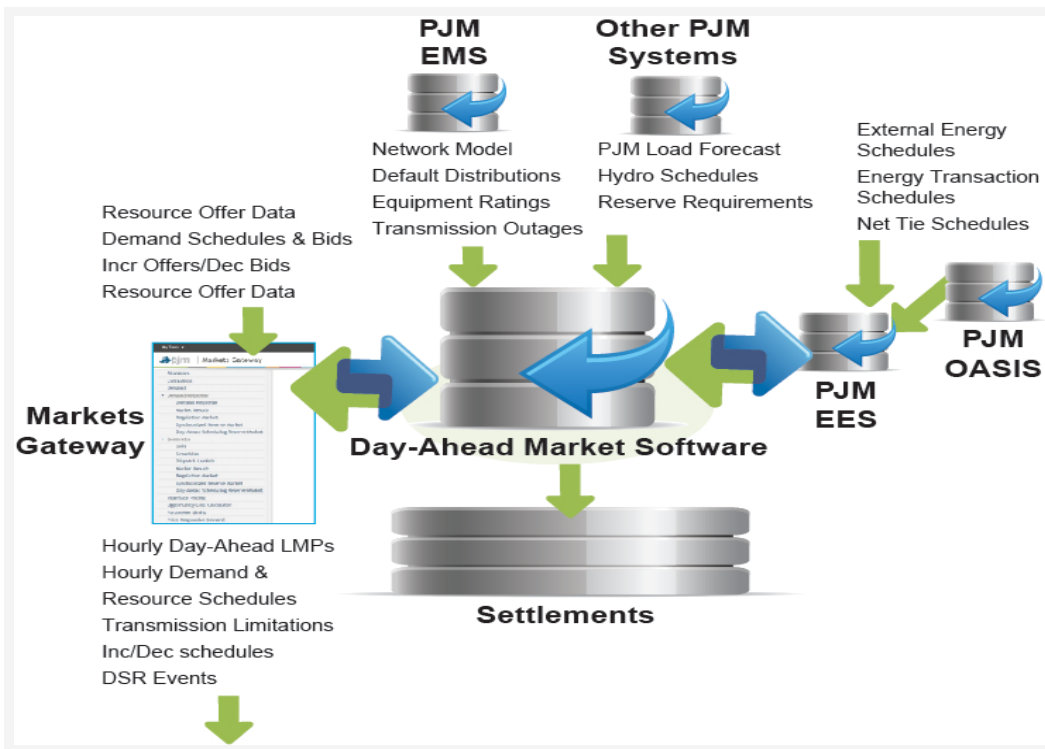

Exhibit 4: Energy Market Data Flow

5.2.7.1 Day-ahead Integer Relaxation

As described in Section 2.1 of this Manual, Day-ahead economic dispatch is performed in the Day-ahead security constrained economic dispatch software program, known as the dispatch

run. Day-ahead prices are calculated in a subsequent execution of the Day-ahead security constrained economic dispatch optimization software program, known as the pricing run. The pricing run executes the same optimization as the dispatch run but additionally applies Integer Relaxation to Eligible Fast-Start Resources. Integer Relaxation is the process by which the commitment status variable for an Eligible Fast-Start Resource is allowed to vary between zero and one, inclusive of zero and one.

5.2.7.2 Energy Offers used in Day-ahead Price Calculation

Day-ahead prices shall be determined for every hour, using the applicable marginal energy offer of the resources being dispatched using the offer schedule on which the resource is committed in the dispatch run. PJM will determine a resource's applicable marginal energy offer by comparing the megawatt output of the resource from the pricing run with the Market Seller's Incremental Energy Offer curve or, for Eligible Fast-Start Resources, the Market Seller's Composite Energy Offer. For Eligible Fast-Start Resources, the amortized Start-Up Costs and amortized No-Load Costs, expressed in dollars per megawatt-hour (\$/MWh), are added to the resource's Incremental Energy Offer to determine a Composite Energy Offer, as described below:

- The amortized Start-Up Cost for a generation resource shall equal the resource's applicable Start-Up Cost amortized over (A) the resource's Economic Maximum or Emergency Maximum output, whichever is applicable and (B) the resource's Minimum Run Time. The Emergency Maximum output will only be used for amortization when PJM Operations declares calling on offline emergency resources or declares deploying emergency segments on online resources. For the purposes of this calculation in Day-ahead, the Minimum Run Time is set to one hour. The amortized Start-Up Cost is included in the resource's Composite Energy Offer during the resource's Minimum Run Time. After the Minimum Run Time has been met the amortized Start-Up Cost is not included in the Composite Energy Offer. To determine the amortized Start-Up Costs for Economic Load Response Participant resources, the Minimum Down Time is used in place of the Minimum Run Time and shutdown cost is used in place of Start-Up Cost in the above equation. The Amortized Start-Up Cost will be adjusted in the Composite Energy Offer, as described in Section 5.2.7.3 of this Manual, if the resource exceeds the reasonably expected cost during the Offer Verification screening process as described in Section 2.6.3.3 of this Manual.
- The amortized No-Load Cost shall equal the resource's applicable No-Load Cost, amortized over the resource's Economic Maximum or Emergency Maximum output, whichever is applicable, and included in the Composite Energy Offer for all hours in which the resource is pool-scheduled. The amortized No-Load Cost will be adjusted in the Composite Energy Offer, as described in Section 5.2.7.3 of this Manual, if the resource exceeds the reasonably expected cost during the Offer Verification screening process as described in Section 2.6.3.3 of this Manual.
- For purposes of calculating Day-ahead Prices, if an Eligible Fast-Start Resource submits a market-based offer that results in a composite Energy Offer that exceeds \$1,000/MWh:

- The amortized Start-Up Cost and the amortized No-Load Cost for the market-based schedule shall both be deemed to exceed the reasonably expected cost from the Composite Energy Offer if the Incremental Energy Offer of the market-based schedule exceeds the Incremental Energy Offer of the associated cost-based offer.
- The amortized Start-Up Cost for the market based schedule shall be deemed to exceed the reasonably expected cost from the Composite Energy Offer if the Start-Up Cost of the associated cost-based offer exceeds the reasonably expected cost or if the Start-Up Cost of the market-based offer exceeds the Start-Up Cost specified on the associated cost-based offer.
- For purposes of calculating Day-ahead Prices, the applicable marginal incremental Energy Offer used in the calculation of Day-ahead Prices shall not exceed \$2,000/MWh.
- If a generation resource that is an Eligible Fast-Start Resource submits an offer that results in a Composite Energy Offer with a maximum segment that exceeds \$2,000/MWh then the amortized Start-Up Cost may be adjusted from the determination of the Composite Energy Offer. If the resulting Composite Energy Offer is still in excess of \$2,000/MWh, then the amortized No-Load Cost may be adjusted from the determination of the Composite Energy Offer.
- If an Economic Load Response Participant resource that is an Eligible Fast-Start Resource submits an offer that results in a Composite Energy Offer with a maximum segment that exceeds \$2,000/MWh then the amortized shutdown cost may be adjusted from the determination of the Composite Energy Offer.

All Fast-Start resources, with the exception of self-scheduled resources that specify intent to not follow dispatch, are eligible to set LMP.

5.2.7.3 Determination of Energy Offer for Generation Resources with Composite Energy Offers Greater Than \$1,000/MWh and equal to or below \$2,000/MWh

When a Fast-Start capable resource submits a Composite Energy Offer that exceeds \$1,000/MWh but is below \$2,000/MWh at the resource's Economic Maximum value, the components that make up the offer are verified for reasonableness as described in Section 2.3.6.3 of this Manual.

If the submitted components of the Composite Energy Offer are deemed not reasonable, adjustments are made to ensure the resulting Composite Energy Offer is no greater than \$2000/MWh as described in the Operating Agreement, Schedule 1, Section 2.4A.

The chart below describes how the Composite Energy Offer components may be adjusted in the event the Start-Up and/or No-Load cost exceed (fail) or do not exceed (pass) the reasonably expected cost for the determination of LMPs.

Scenario	Submitted Composite Energy Offer at EcoMax (\$/MWh)	Submitted Incremental Energy Offer ("IEO")	Reasonability Test Results		Composition of Composite Energy Offer*	Adjustment and/or Offer Capping
			Submitted Start-Up Cost	Submitted No-load Cost		
1	≤ \$1,000	≤ \$1,000	N/A	N/A	IEO + ASU + ANL	No Offer Verification Trigger
2	\$1,000 < Offer ≤ \$2,000	≤ \$1,000	Pass	Pass	IEO + ASU + ANL	None
3	\$1,000 < Offer ≤ \$2,000	≤ \$1,000	Pass	Fail	IEO + ASU + adjustment (If needed)	Cap at the higher of \$1000 or IEO + ASU; No-load Cost may be included to cap offer at \$1,000
4	\$1,000 < Offer ≤ \$2,000	≤ \$1,000	Fail	Pass	IEO + ANL + adjustment (If needed)	Cap at the higher of \$1000 or IEO + ANL; Start-Up Cost may be included to cap offer at \$1,000
5	\$1,000 < Offer ≤ \$2,000	≤ \$1,000	Fail	Fail	IEO + Adjustment (If needed)	IEO Offer plus No-load Cost, up to submitted value to cap Composite Energy Offer to \$1,000; Use Start-Up Cost, if additional cost are needed.
6	\$1,000 < Offer ≤ \$2,000	\$1,000 < Offer ≤ \$2,000	Pass	Pass	IEO +ASU +ANL	None
7	\$1,000 < Offer ≤ \$2,000	\$1,000 < Offer ≤ \$2,000	Pass	Fail	IEO +ASU	None
8	\$1,000 < Offer ≤ \$2,000	\$1,000 < Offer ≤ \$2,000	Fail	Pass	IEO +ANL	None
9	\$1,000 < Offer ≤ \$2,000	\$1,000 < Offer ≤ \$2,000	Fail	Fail	IEO	Incremental is verified above \$1000, no additional cost are added

*The Start-Up Cost and No-Load cost included in a Composite Energy Offer are amortized. In this chart, "ASU" represents amortized Start-Up Cost, "ANL" represents amortized No-Load Cost. Please refer to Section 5.2.7.2 for how the amortization process applies to the Start-Up and No-Load costs.

5.2.7.4 Determination of Energy Offer for Generation Resources with Offers Greater than \$2,000/MWh

Generation resources with cost based Incremental Energy Offers in excess of \$2,000/MWh are cleared in economic merit order but are capped at \$2,000/MWh for the purposes of calculating LMP.

5.2.7.5 Determination of Energy Offer for Composite Energy Offers Greater than \$2,000/MWh

When a Fast-Start capable generation resource submits a Composite Energy Offer with a maximum segment that exceeds \$2,000/MWh, the components that make up the offer are verified for reasonableness as described in Section 2.3.6.3 of this Manual. Based on the results of the reasonableness verification, adjustments are made to ensure the resulting Composite

Energy Offer is no greater than \$2,000/MWh as described in the Operating Agreement, Schedule 1, Section 2.4A.

The chart below describes how the Composite Energy Offer components may be adjusted in the event the Start-Up and/or No-Load cost exceed (fail) or do not exceed (pass) the reasonably expected cost for the determination of LMPs.

Scenario	Submitted Composite Energy Offer at EcoMax (\$/MWh)	Submitted Incremental Energy Offer ("IEO")	Reasonability Test Results		Composition of Composite Energy Offer*	Adjustment and/or Offer Capping
			Submitted Start-Up Cost	Submitted No-load Cost		
1	> \$2,000	≤ \$1,000	Pass	Fail	IEO + ASU + adjustment (If needed)	1) IEO + ASU or 2) If Incremental + ASU ≤ \$1,000, cap at \$1,000; Add ANL to cap at \$1000, if needed 3) If Incremental + ASU > \$2,000, cap at \$2,000; Adjust down ASU to cap offer at \$2000
2	> \$2,000	≤ \$1,000	Fail	Pass	IEO + ANL + adjustment (If needed)	1) IEO + ANL or 2) If Incremental + ANL ≤ \$1,000, cap at \$1,000; Add ANL to cap at \$1000, if needed 3) If Incremental + ANL > \$2,000, cap at \$2,000; Adjust down ANL to cap offer at \$2000
3	> \$2,000	≤ \$1,000	Fail	Fail	IEO + adjustment (If needed)	Cap Composite Energy Offer at \$1,000; first include ANL up to submitted No-load Cost and if needed, include ASU until Composite Energy Offer = \$1,000
4	> \$2,000	≤ \$1,000	Pass	Pass	IEO + ASU + ANL	Cap Composite Energy Offer at \$2,000; adjust down ASU first to zero, ANL, until Composite Energy Offer equals \$2,000.
5	> \$2,000	> \$1,000	Pass	Pass	IEO + ASU + ANL	If IEO+SU+NL is greater than \$2000, Cap Composite Energy Offer at \$2,000; adjust down ASU first to zero, then ANL down to zero, until Composite Energy Offer equals \$2,000.
6	> \$2,000	> \$1,000	Pass	Fail	IEO + ASU	Exclude ANL from Composite Energy Offer, if resultant Composite Energy Offer > \$2,000 then cap Composite Energy Offer at \$2,000 by adjusting Start-Up Cost
7	> \$2,000	> \$1,000	Fail	Pass	IEO + ANL	Exclude ASU from Composite Energy Offer, if resultant Composite Energy Offer > \$2,000 then cap Composite Energy Offer at \$2,000 by adjusting No-load Cost
8	> \$2,000	> \$1,000	Fail	Fail	IEO	Exclude ASU and ANL from Offer, Composite Energy Offer = IEO, since IEO above \$1,000

*The Start-Up Cost and No-Load Cost included in a Composite Energy Offer are amortized. In this chart, "ASU" represents amortized Start-Up Cost, "ANL" represents amortized No-Load Cost. Please refer to Section 5.2.7.2 for how the amortization process applies to the Start-Up and No-Load costs.



Section 6: Section Retired

Section 7: External Transaction Scheduling

Welcome to the External Transaction Scheduling section of the PJM Manual: Energy & Ancillary Services Market Operations. In this section you will find the following information:

- How PJM may utilize a net interchange cap to manage interchange during emergency conditions.
- An overview description of PJM-MISO Coordinated Transaction Scheduling (see “Overview of PJM-MISO Coordinated Transaction Scheduling”).
- A list of the PJM-MISO Coordinated Transaction Scheduling Business Rules (see “PJM-MISO Coordinated Transaction Scheduling Business Rules”).

Other information regarding External Transaction Scheduling, including that of PJM-MISO Coordinated Transaction Scheduling, is contained in the [PJM Regional Transmission and Energy Scheduling Practices](#) document.

7.1 Net Interchange Cap

During emergency conditions, PJM may elect to implement a cap on net interchange transactions to mitigate the impact of interchange volatility on system and price stability. The net interchange cap represents the maximum level of RTO-wide net interchange beyond which the scheduling of additional non-dispatchable transactions using Spot Market Import or non-firm hourly point-to-point transmission service is disallowed.

The net interchange cap may be implemented for the peak hour(s) of the day and the several surrounding hours when the following conditions are met. The application of the cap is evaluated individually for each eligible hour.

- A Hot or Cold Weather Alert or escalating emergency procedure(s) as defined in PJM Manual 13: Emergency Operations for the RTO, Mid-Atlantic Dominion or Mid-Atlantic regions is in effect for the hour.
- PJM dispatch has called on firm resources whose minimum operating criteria must be honored for the hour (e.g., dispatched demand response resources or combustion turbines).
- The level of interchange anticipated by PJM dispatch at the time the firm resource commitments are made, coupled with the firm resource commitments, are sufficient to meet the projected load pickup for the hour.

When implemented, the interchange cap will apply for the entire hour. PJM dispatch may subsequently elect to adjust the interchange cap intra-hour in response to reliability concerns. The interchange cap value will be set equal to the interchange MW anticipated by PJM dispatch at the time the cap is implemented plus a 700 MW margin to allow additional interchange to be

scheduled following the implementation of the cap in accordance with interchange scheduling rules.

Market participants will be notified of the potential for the implementation of the interchange cap Day-ahead when a Hot Weather Alert or Cold Weather Alert has been issued for the operating day. Notification of the actual implementation of the cap will occur as soon as the cap is implemented. The interchange cap will typically be implemented one to two hours in advance of the hour to which it is applied, coincident with the scheduling of additional firm resources. The implementation notification will include the hour(s) to which the cap applies and the MW value at which the net interchange cap has been set. Notifications will occur via the Emergency Procedures Posting Application.

7.2 Overview of the PJM-MISO Coordinated Transaction Scheduling

PJM-MISO Coordinated Transaction Scheduling (PJM-MISO CTS) is an optional product available for scheduling Real-time Energy Market transactions between PJM and MISO. PJM-MISO CTS facilitates the efficient scheduling of interchange between the two regional transmission organizations (RTO) by utilizing forecasted LMPs, from the pricing run and participant-provided interface bids to clear only those transactions deemed economically consistent with projected interface price spreads.

Market Participants submit PJM-MISO CTS bids in PJM's ExSchedule system. Validated bids are then passed to both PJM and MISO's look-ahead commitment engines. In Real-time, PJM sends MISO the forecasted LMPs from the pricing run, calculated for PJM's MISO interface, while MISO sends PJM the forecasted LMPs calculated for MISO's PJM interface to use as inputs to the CTS clearing process. Every 15 minutes in Real-time, each RTO uses its look-ahead commitment engine to clear only those CTS bids that have an interface bid price that is less than or equal to the projected interface price positive spread and which is scheduled in the direction that is consistent with that price positive spread.

The look-ahead commitment engine clearing of CTS bids is based on the pricing run. PJM and MISO then exchange the CTS clearing results. A common clearing process then reconciles the CTS bids independently cleared by PJM and MISO. For each CTS bid, only those transaction megawatts (MW) that were cleared by both PJM and MISO are scheduled to flow.

7.3 PJM-MISO Coordinated Transaction Scheduling Business Rules

Please refer to the PJM Regional Transmission and Energy Scheduling Practices for rules governing the submission of PJM-MISO CTS transactions.

7.3.1 CTS Bid Clearing

The Intermediate Term Security Constrained Economic Dispatch (IT SCED) engine clears CTS bids in PJM. A similar engine clears CTS bids for MISO. Only the CTS bids commonly cleared

between PJM and MISO are scheduled to flow. The reconciliation of commonly cleared CTS bids is discussed in Section 7.3.2.

In preparation for CTS clearing, IT SCED receives CTS bids plus the forecasted interface LMP for MISO’s PJM interface. Using these inputs plus the forecasted LMP for PJM’s MISO interface which is calculated within the IT SCED case. IT SCED clears a CTS bid segment if one of the following conditions is satisfied:

- For a bid scheduled from PJM to MISO:

$$\text{If CTS bid segment price (\$)} < = \$MISO_interface - \$PJM_interface$$

- For a bid scheduled from MISO to PJM:

$$\text{If CTS bid segment price (\$)} < = \$PJM_interface - \$MISO_interface$$

Where:	
\$PJM_interface:	LMP for the MISO interface as calculated by PJM
\$MISO_interface:	LMP for the PJM interface as calculated by MISO

In the event that only a portion of the CTS MW offered are needed in order to satisfy power balance in the IT SCED case, CTS MW bid segments may be partially cleared. In the case of a tie among multiple bids, cleared MWs are prorated across tying bids based on the size of the marginal MW segment for each tying bid. The proration of cleared MW across tying bids is calculated based on the following formula:

$$MW_{transaction} = MW_{needed\ for\ power\ balance} * (MW_{from\ transaction's\ marginal\ segment} / total\ MW\ available\ at\ tying\ CTS\ Bid\ Price)$$

7.3.2 CTS Common Clearing

Common Clearing is a process that reconciles the results of CTS clearing from the MISO CTS and PJM IT SCED solutions. For each CTS bid, only those transaction MW that are cleared by both PJM and MISO are scheduled to flow. Therefore:

$$Commonly\ Cleared\ CTS\ Transaction\ MW = minimum$$

$$\left(ClearedMW_{PJM_CTS_x}, ClearedMW_{MISO_CTS_x} \right)$$

The Common Clearing process executes for each 15 minute scheduling interval (HH:00, HH:15, HH:30, HH:45) at approximately 25 minutes before the start of the CTS transaction. For

example, the common clearing process for 12:00 runs at approximately 11:35. The RT SCED application treats all cleared CTS transactions as a fixed interchange value.

The commonly cleared CTS results are posted in the ExSchedule portal immediately following the execution of the common clearing process. Please see the PJM Regional Transmission and Energy Scheduling Practices for additional details regarding the communication of CTS clearing results.

7.3.3 CTS Clearing Suspension

For reliability or system maintenance reasons, either PJM or MISO may suspend the evaluation and clearing of CTS transactions temporarily. During the affected time, all CTS transaction are cleared to 0 MW. Possible reasons for CTS suspension include but are not limited to:

- Emergency operational conditions where all export transactions with non-firm transmission service are being curtailed;
- Initiation of Maximum Emergency Generation Action procedures;
- Scheduled system outage / maintenance;
- Inability to send/receive accurate forecast LMP data to/from partner RTO;

A message will be displayed in the ExSchedule system whenever CTS suspension is in effect.

7.3.4 CTS Settlement

PJM-MISO CTS transactions are settled in the same manner as typical Real-time interchange transactions. The projected IT SCED interface LMPs, from the pricing run, are used for clearing purposes only. CTS transactions are settled at the Real-time interface LMPs, from the pricing run as finalized via the LMP verification process as described in Section 2.10. CTS transactions are not eligible for make whole payments if the Real-time PJM-MISO interface price spread does not cover the CTS bid price.

Section 8: Posting OASIS Information

Section Removed: Information regarding Posting OASIS Information is contained in the online OASIS User Guide, which is available at: <https://www.pjm.com/-/media/etools/oasis/oasis-user-guide.ashx>.

Section 9: Hourly Scheduling

Welcome to the Hourly Scheduling section of the PJM Manual for Energy & Ancillary Services Market Operations. In this section, you will find the following information:

- How schedules may be adjusted on an hourly basis (see “Hourly Scheduling Adjustments”).
- How pre-planned operating schedules may be changed by PJM or PJM Members to reflect new conditions (see “Self-Schedule Adjustments”).

9.1 Hourly Schedule Adjustments

At times Market Sellers may benefit from having the ability to differentiate and update their offers and other associated parameters, on an hourly basis to more accurately reflect their true cost of generation or account for other operating conditions. This section discusses the timing, parameters, and process for updating schedules for use in the Real-time Energy Market.

Generation and Demand Resources may alter their offers for use in the Real-time Energy Market during the following periods (Real-time update periods):

- During the Generation Rebidding Period which is defined from the time PJM posts the results of the Day-ahead Energy Market until 14:15.
- Starting at 18:30 (typically after the Reliability Assessment and Commitment (RAC) Run is completed) and up to 65 minutes prior to the start of the operating hour (T-65 min).

The following generation offer parameters may be updated during the Real-time update periods, with exceptions as noted below:

- Incremental Offer Price
 - For Price-based offers, the Incremental Offer Price may be increased or decreased for uncommitted hours, but may only be decreased for committed hours. When determining whether an update constitutes an increase or decrease, each segment of the updated offer curve will be compared to each segment of the incremental offer curve that existed for the schedule and hour at the time the resource most recently received a commitment for that hour.
 - For Cost-based offers, the Incremental Offer Price may be increased or decreased for both committed and uncommitted hours.
- Incremental Offer MW
 - During the Generation Rebidding Period, Offer MW may only be updated for hours that did not receive a commitment in the Day-ahead Market.
 - Following the close of the Generation Rebidding Period, no updates to the Offer MW may be made, regardless of resource commitment status.

- Emergency Minimum and Maximum MW Limits
 - These parameters are not subject to the T-65 min update deadline and may be updated through the end of the operating hour to which the updates apply.
- Economic Minimum and Maximum Limits
 - These parameters are not subject to the T-65 min update deadline and may be updated through the end of the operating hour to which the updates apply.
- Startup Cost (Cold, Intermediate, Hot) and No-Load Cost
 - Cost-based Startup and No-Load values (on either a Price-based or Cost-based schedule) may be increased or decreased for both committed and uncommitted hours.
 - Price-based Startup and No-Load values may not be updated outside of the open enrollment periods as specified in Section 2.3.3 of this Manual.
- Minimum Run Time
 - Hourly differentiated Minimum Run Time values are only considered for use during Real-time commitment and dispatch.
 - Minimum Run Time may not be updated for any hour that has received a commitment in the Day-ahead or Real-time Market.
- Notification Time
 - Hourly differentiated Notification Time values are only considered for use during Real-time commitment and dispatch.
- Ramp Rate
 - MW Limits
 - Following the close of the Day-ahead bidding window, no updates to the Ramp Rate MW Limits are permitted.
 - Ramp Rates
 - Hourly differentiated Ramp Rates may be updated for both committed and uncommitted hours.
- Schedule Availability
 - During the Generation Rebidding Period, Schedule Availability may only be updated for schedules that did not receive a commitment in the Day-ahead Market.
 - No updates to Schedule Availability may be made following the close of the Generation Rebidding Period, regardless of schedule commitment status, except for dual fuel resources.
 - Resources designated as “Dual Fuel Capable” in Markets Gateway may submit hourly differentiated schedule availability for Cost-based schedules following the close of the Generation Rebidding Period, for uncommitted hours only, in order to communicate fuel availability.
- Switch to Cost Schedule Flag

- May not be updated during the Generation Rebidding Period.
- Any hourly updates made to the Offer Updates or Detail Updates pages of Markets Gateway supersede the daily values on the Offer and/or Detail pages. Hourly updates made on the Offer Updates or Detail Updates pages are not automatically carried over into the next operating day.

The following Demand Resource offer parameters may be updated during the Real-time update periods, with exceptions as noted below:

- Incremental Offer Price
 - Offer Price may not be updated for any hour that has received a commitment in the Day-ahead or Real-time Market.
- Incremental Offer MW
 - During the Generation Rebidding Period, Offer MW may only be updated for hours that did not receive a commitment in the Day-ahead Market.
 - No updates to Offer MW may be made following the close of the Generation Rebidding Period, regardless of resource commitment status.
- Economic Minimum and Maximum MW Limits
- Shutdown Cost
 - Shutdown Cost may not be updated for any hour that has received a commitment in the Day-ahead or Real-time Market.
- Minimum Down Time Limit
 - Hourly differentiated Minimum Down Time is only considered for use during real-time commitment and dispatch.
 - Minimum Down Time may not be updated for any hour that has received a commitment in the Day-ahead or Real-time Market.
- Notification Time
 - Hourly differentiated Notification Time is only considered for use during Real-time commitment and dispatch.
- Any hourly changes made on the Offer Updates or Hourly Updates screens in Markets Gateway supersede the values on the Offers and Parameter pages.

The following Hybrid Resource and ESR participation model offer parameters may be updated during the Real-time update periods, with exceptions as noted below:

- Mode selection (charge, discharge, continuous, unavailable, intermittent)
- Economic Minimum and Maximum Charge Limits
 - These parameters are not subject to the T-65 min update deadline and may be updated through the end of the operating hour to which the updates apply.
- Economic Minimum and Maximum Discharge Limits

- These parameters are not subject to the T-65 min update deadline and may be updated through the end of the operating hour to which the updates apply.
- Emergency Minimum and Maximum Charge Limits
 - These parameters are not subject to the T-65 min update deadline and may be updated through the end of the operating hour to which the updates apply.
- Emergency Minimum and Maximum Discharge Limits
 - These parameters are not subject to the T-65 min update deadline and may be updated through the end of the operating hour to which the updates apply.
- Hourly state of charge (for informational purposes only)
 - This parameter, in megawatts (MW), is managed by the participant and manually entered to reflect the state of charge for an ESR. This data is optional and will only be used for PJM research purposes.

9.1.1 Intraday Offers Optionality

The ability to submit intraday offers in Markets Gateway is an optional feature. Market Sellers who wish to submit updates to their generation resource's cost-based offer after the close of the Generation Rebidding Period have to formally opt in to intraday updates in Markets Gateway and describe the intraday update process in the resource's Fuel Cost Policy. By default, generation resources are designated as opted out of intraday offers.

Market Sellers may still submit hourly offers for a generation resource that has been opted out of intraday offers into the Day-ahead Market and update those offers during the Generation Rebidding Period for any hours not committed in the Day-ahead Market. However, the Market Seller cannot submit any offer parameter updates following the close of the Generation Rebidding Period, except as follows:

- Economic Minimum and Maximum Operating Limits, Emergency Minimum and Maximum Operating Limits and other information on the Unit Hourly Updates screen in Markets Gateway may still be updated through the end of the operating hour. Hourly differentiated Notification Time and Ramp Rate may be updated through T-65 minutes.
- Market Sellers that opt-out of Intraday Updates may not specify hourly differentiated Minimum Run Time values.
- Certain Regulation Offer parameters may be updated in Real-time as specified in Section 3.2.2 of this Manual.
- Certain Synchronized Reserve Offer parameters may be updated in Real-time as specified in Section 4.2.4 of this Manual.

For Market Sellers that have opted in, any intraday updates to Cost-based offers must comply with the criteria defined in the resource's approved Fuel Cost Policy.

Market Sellers must specify the opt-in/opt-out election for each generation resource individually. The election to opt in to intraday cost-based offer updates must be specified in the generation

resource's Fuel Cost Policy. Market Sellers should opt the resource out of intraday cost-based offer updates in Markets Gateway if the resource's Fuel Cost Policy does not specify methods for intraday offer updates.

Opt-in/opt-out elections apply, at a minimum, on a monthly basis. Market Sellers must designate their election by midnight of the 15th day of the month prior to the month the election will begin. The election will continue until the user cancels. An exception to this deadline will apply to election changes that are driven by a change to the frequency of cost determination in the resource's approved Fuel Cost Policy. In this case, the election may be changed upon approval of the revised Fuel Cost Policy.

9.2 Self-Schedule Adjustments

During the course of Bulk Electric System operations, planned and unplanned events may continually occur. This section discusses the process by which pre-planned operating schedules may be changed by PJM or PJM Members to reflect new conditions.

A PJM Member may adjust the schedule of a resource under its dispatch control (Self-Scheduled Resource) on an hour-to-hour basis beginning at 22:00 of the day before the Operating Day under the following conditions:

- Subject to the right of PJM to schedule and dispatch Self-Scheduled Resources in an Emergency.
- Provided that PJM is notified no later than 65 minutes prior to the hour in which the adjustment is to take effect.

The following adjustments may be made:

- A PJM Member may self-schedule any of its resource increments, including hydropower resources not previously designated as Self-Scheduled Resources and not selected as a PJM RTO – Scheduled Resource.
- A PJM Member may request the scheduling of a new Bilateral Transaction that uses non-firm transmission service.
- A PJM Member may remove from service a resource increment, including a hydropower resource that it had previously designated as a Self-Scheduled Resource, provided that PJM has the option to schedule energy from such resource increment at the price offered in the scheduling process, with no obligation to pay any start-up fee.

An External Market Buyer may refuse delivery of some or all of the energy it requested to purchase by notifying PJM Dispatch of the adjustment in deliveries no later than 20 minutes prior to the hour in which the adjustment is to take effect. Any such refusal of delivery shall be subject to non-delivery charges as described in the PJM Manual 28: [Operating Agreement Accounting](#).

Section 10: Overview of the Demand Resource Participation

Welcome to the Overview of the Demand Resource Participation section of the PJM Manual Energy & Ancillary Services Market Operations. In this section you will find the following information:

- An overview description of the Demand Resource Participation in the PJM Energy Market (see “Overview of the Demand Resource Participation”).
- A list of the Demand Resource Registration Requirements (see “Demand Resource Registration Requirements”).
- A list of the Demand Resource Economic Energy Market Participation (see “Demand Resource Economic Energy Market Participation”).
- A list of the Demand Resource Metering and Settlement Data Requirements (see “Demand Resource Metering and Settlement Data Requirements”).
- A list of the aggregation rules for Economic and Pre-Emergency/Emergency Demand Resources (see “Aggregation for Economic and Pre-Emergency/Emergency Demand Resources”).
- A list of the interval meter equipment and load data requirements (see “Interval Meter Equipment and Load Data Requirements”).
- A list of the rules regarding the use of Sub-meter load data (see “Use of Sub-meter Load Data to Support Demand Response Regulation Compliance”).

10.1 Overview of Demand Resource Participation

The integration of Demand Response (DR) into the PJM Markets recognizes the importance of Load Response to a fully functioning market as well as the effect of Load Response on the reliability of the grid. The purpose of these rules is to enable Demand Resources under the direction and control of Curtailment Service Providers (CSPs) to participate in the various PJM markets. CSPs are Members or Special Members of PJM that participate in the PJM Markets by causing Demand Resources to reduce demand.

PJM Emergency or Pre-Emergency Load Response enables Demand Resources that reduce load during emergency or pre-emergency conditions to receive payment for those reductions.

- Demand Resources in the Energy Only Option of Emergency Load Response are defined as Demand Resources that receive only an energy payment for reductions.
- Demand Resources in Full Emergency or Pre-Emergency Load Response are defined as Demand Resources that receive both an energy payment for reductions and a capacity payment.

- Demand Resources in Capacity Only Option of Emergency or Pre-Emergency Load Response are defined as Demand Resources that receive only a capacity payment for reduction.

PJM Economic Load Response enables Demand Resources to respond to PJM Energy, Synchronized Reserve, and/or Secondary Reserve prices by reducing consumption and receiving a payment for the reduction or following PJM signal to reduce or increase load if providing regulation services.

- The Day-ahead Option provides a mechanism by which any qualified Market Participant may offer Demand Resources the opportunity to reduce the load they draw from the PJM system in advance of Real-time operations and receive payments based on Day-ahead LMP for the reductions.
- The Real-time Option provides a mechanism by which any qualified Market Participant may offer Demand Resources the opportunity to commit to a reduction and receive payments based on Real-time LMP for the reductions.

Energy Settlements shall be limited to demand reductions that are executed in response to the Real-time and/or Day-ahead LMP or as dispatched by PJM and that are not implemented as part of normal operations. Reductions that do not meet these requirements are not eligible for settlement. Examples of ineligible settlements include, but are not limited to the following:

- Settlements based on variable demand where the timing of the demand reduction supporting the settlement did not change in direct response to the Real-time and/or Day-ahead LMP.
- Consecutive daily settlements that are the result of a change in normal demand patterns that are submitted to maintain a Customer Baseline Load (“CBL”) that no longer reflects the relevant end-use customer’s demand.
- Settlements based on On-Site Generator data if the On-Site Generation is not supporting demand reductions executed in response to the Real-time and/or Day-ahead LMP.
- Settlements based on demand reductions that are the result of operational changes between multiple end-use customer sites in the PJM footprint except that settlements based on such demand reduction shall be allowed if the demand reduction alleviates congestion.
- Settlements based on load reductions from normal operations that would have occurred without PJM dispatch, or that would have occurred absent PJM energy market compensation as approved under Order 745.

PJM shall disallow settlements for demand reductions that do not meet the requirements set forth above. If the CSP continues to submit settlements for demand reductions that do not meet the requirements set forth above then PJM shall suspend the CSP’s Energy Market activity and refer the matter to the FERC Office of Enforcement.

10.1.1 Economic Load Response Participant Review Process

PJM shall review the participation of a CSP, EDC and/or LSE in the Energy Market under the following circumstances:

- The CSPs registrations are disputed more than 10% of the time by the relevant EDC or LSE.
- The CSP's settlements are disputed more than 10% of the time by the relevant EDC or LSE.
- The CSP's settlements are denied by PJM more than 10% of the time.

PJM shall have thirty (30) days to conduct the required review. PJM may refer the matter to the PJM MMU and/or the FERC Office of Enforcement if the review indicates the relevant CSP and/or EDC or LSE is engaging in activity that is inconsistent with the Economic Load Response rules.

10.2 Demand Resource Registration Requirements

CSPs shall register Demand Resources that choose to participate in the PJM Energy, Capacity, Synchronized Reserve, Day-ahead Scheduling Reserve or Regulation Market according to the rules and requirements set forth below. A CSP is required to have effective agreement with a customer to register a location.

10.2.1 Registration combinations

One or more CSPs may register the same location (EDC account number) to one or more registrations based on the following conditions:

Scenario	Economic (Energy, SR, SecR, Reg)	Economic (Energy Only)	Economic Regulation Only	Emergency or Pre-Emergency Capacity Only	Emergency or Pre-Emergency Full (Capacity and Energy)	Emergency Energy Only
CSP1	Yes	No	No	No	Yes	No
CSP1	Yes	No	No	Yes	No	Yes
CSP1 CSP2	Yes No	No No	No No	No Yes	No No	Yes No
CSP1 CSP2	No No	No Yes	Yes No	No No	No Yes	No No
CSP1	No	Yes	Yes	No	No	Yes

Scenario	Economic (Energy, SR, SecR, Reg)	Economic (Energy Only)	Economic Regulation Only	Emergency or Pre-Emergency Capacity Only	Emergency or Pre-Emergency Full (Capacity and Energy)	Emergency Energy Only
CSP2	No	No	No	Yes	No	No
CSP1	No	No	Yes	No	No	No
CSP2	No	Yes	No	No	No	Yes
CSP3	No	No	No	Yes	No	No

Economic (Energy, SR, SecR, Reg) – a registration that allows participation in the energy market and ancillary service market(s) if certified and approved by PJM.

Economic (Energy Only) – an economic registration that only allows participation in the Energy market. This is normally used when one economic CSP has an Economic Regulation Only registration and the second economic CSP has the Economic (Energy Only) registration.

Economic Regulation Only – a registration that only allows participation in the Regulation market.

Emergency Capacity Only – a registration that only allows participation in the Capacity market as an RPM or FRR capacity resource. If the registration is dispatched for emergency conditions the resource does not receive an energy payment. Only resources that rely on On-Site Generation to fulfill its load reduction obligations and have environmental restrictions as defined and required by applicable local, state or federal law, ordinances and regulations, on when it can operate such that it is only permitted to operate if PJM is in emergency conditions may register as an Emergency Capacity Only resource.

Pre-Emergency Capacity Only – a registration that only allows participation in the Capacity market as an RPM or FRR capacity resource. If the registration is dispatched for Pre-Emergency conditions the resource does not receive an energy payment.

Emergency Full (Capacity and Energy) – same as Emergency Capacity Only registration but receives emergency energy compensation when dispatched for emergency conditions. Only resources that rely on On-Site Generation to fulfill its load reduction obligations and have environmental restrictions on when it can operate such that it is only permitted to operate if PJM is in emergency conditions may register as an Emergency Full resource.

Pre-Emergency Full (Capacity and Energy) – same as Pre-Emergency Capacity Only registration but receives emergency energy compensation when dispatched for Pre-Emergency or emergency conditions.

Locations that register with one CSP for Emergency Full or Pre-Emergency Full can register with a second CSP only for Economic Regulation-Only.

Locations that register with one CSP for Emergency Capacity Only or Pre-Emergency Capacity Only can register with a second CSP for:

- Economic (Energy, SR, SecR, Reg) or;
- Economic (Energy Only) and/or;
- Economic Regulation Only.

Locations that register with one CSP for Emergency Capacity Only or Pre-Emergency Capacity Only, and with a second CSP for Economic Regulation Only, can also register with a third CSP for Economic (Energy Only).

A single location may only register as either a Pre-Emergency or an Emergency resource for the Delivery Year.

10.2.2 Curtailment Service Providers

The following business rules apply to CSPs:

- Prior to participating in the PJM Markets, CSPs must complete a registration in the appropriate PJM Tool which identifies the specific location(s) based on the unique EDC account number that will participate and their associated load reduction capability. CSPs shall maintain the accuracy of the registration information provided to PJM for each demand resource and each time the CSP registers the location or extends the registration, the CSP will review all information to ensure it is reasonably accurate and update as necessary. CSPs shall not include Critical Natural Gas Infrastructure locations in the registration. On a periodic basis, PJM may request supporting information from the CSP to verify that the information provided by the CSP is reasonably accurate.
- In order to register demand resources all specific information as defined in the DR Hub User Guide shall be provided including the following:
 - Business Segment - CSPs shall classify locations according to the location's primary purpose or business use. CSPs should first determine if the location's business use falls under one of the following primary categories: Hospitals, Industrial / Manufacturing, Multiple Dwelling Unit, Office Building, Residential, Retail Service, Correctional Facilities or Schools. In cases where the location does not fit into one of the primary categories the CSP shall select from one of the following categories: Agriculture, Forestry and Fishing, Mining, Transportation, Communications, Electric, Gas and Sanitary Services or Services. A description of each category is included in the DR Hub user guide.

- Max Load – CSPs best estimate of annual peak load.
- Load Reduction Method and associated Capability - The CSPs shall provide for each location the load reduction method and the associated load reduction kilowatt capability. Load reduction methods indicate the type of electrical equipment that is controlled to provide the demand response activity and include: Heating, Ventilation and Air Conditioning (HVAC), Lighting, Refrigeration, Manufacturing, Water Heaters, Batteries, Plug Load and Generation.
 - A Plug Load represents an electronic device that is plugged into a socket, which is not already represented by the methods described above. Examples of Plug Load include IT Peripherals, such as large computers, monitors, printers, routers, copiers and scanners or appliances such as washers, dryers or dishwashers.
- The CSP shall provide the load reduction kilowatt capability for each method which represents a reasonable estimate of the location's expected hourly energy load reduction (at the retail meter) that will be performed during a system emergency when wholesale energy prices are high and the resource participates in the wholesale market. The load reduction kilowatt capability may be significantly different than the capacity commitment or the economic energy offered into the wholesale market on a daily basis. The load reduction capability should not reflect the entire load for the location unless the location expects to reduce all load during a PJM emergency when participating in the wholesale capacity and/or energy market. If Generation will be used to reduce all of the load at the location and the location will reduce load with other load reduction methods then the Generation load reduction capability should reflect the expected load after the other load reduction methods have been deployed. This allows the sum of each load reduction method capability (Max Output) to reflect the total load reduction capability for the location.
- The CSP shall report the following generation attributes for each generation unit at the location. Only locations with On-Site Generation that are used to provide the load reduction and have environmental restrictions as defined and required by applicable local, state or federal law, ordinances and regulations that require emergency conditions to operate may qualify as an Emergency Demand Resource. Multiple generators may be listed.
 - Non-Retail BTMG – CSPs shall indicate if the generator is used to serve multiple retail electricity customers with use of a distribution system. This would typically be located in a municipal electric system or electric cooperative.
 - Max Output – CSPs shall provide PJM with the kW output that the generator will use for PJM Demand Response load reduction.
 - Backup Generator Only – CSPs shall indicate if the generator is used exclusively to maintain electricity during an unexpected or unplanned disconnection from the grid or for PJM Demand Response load reduction. CSPs should select “No”, if a generator typically operates to reduce load (peak shaving, combined heat and power/cogen, etc.).

- On-Site Generator Type - CSPs shall provide PJM with the type of On-Site Generation used for load reduction. On-Site Generator types are: Internal Combustion Engine, Combustion Turbines, Steam Engines and Cogeneration units (this also includes Central Heat and Power units).
- Generator Fuel Type - Locations that use generators, in whole or in part as a load reduction method, shall provide PJM with the primary fuel type used for each generator which includes: Coal, Diesel, Natural Gas, Oil, Gasoline, Kerosene, Propane, Wood, Landfill Gases and Waste products. In cases where the On-Site Generator has a mixed fuel type, CSPs should report on the primary fuel source as the On-Site Generator fuel type.
- Generator Vintage - The year the generator was built (included on nameplate). If the exact year is unknown, the CSPs should use a reasonable estimate.
- Generator Retrofit Year - If the generator was retrofitted for pollution control equipment please include the year of the retrofit or a reasonable estimate of the year if the specific year is not available.
- Nameplate Capacity - MW rated capacity for the generator.
- Permit Status - The current status of environmental permits for the generator where:
 - "Available" - indicates that the CSP represents to PJM that the end-use customer generator has all the Local, State and Federal permits required to operate in the PJM Market as a demand response resource. Unless notified otherwise, PJM shall deem such representation applies to each time the On-Site Generator is used to reduce demand to participate in the PJM markets and that the On-Site Generator is being operated consistent with all applicable permits.
 - "Permit Application in Progress" - indicates that the CSP represents to PJM that one or more of the required Local, State and/or Federal permits for the end-use customer generator are pending and are expected to be received prior to the effective date of registration. The CSP will terminate the registration, if the On-Site Generator is the only source for the demand response activity, and update the status if necessary permits are not received prior to such end-use customer generator's registration effective date.
 - "Not Applicable" – indicates that the CSP represents to PJM that one or more of the Local, State and/or Federal permits for the end-use customer generator are not required for the generator to participate as a Demand Resource and all other necessary permission from appropriate Local, State and Federal environmental agencies has been received.
 - Permit Type – The permit type indicates whether On-Site Generators can run during emergency or non-emergency conditions:
 - "Emergency Only" – An "Emergency Only" permit type indicates that the On-Site Generator has the Local, State and Federal permits required to operate in the PJM Market as a demand response resource during grid emergency conditions. This also

indicates that such locations may qualify as an Emergency resource instead of being a Pre-Emergency resource.

- “Non-Emergency” – A “Non-Emergency” permit type indicates that the On-Site Generator has the Local, State and Federal permits required to operate in the PJM Market as a demand response resource during emergency and non-emergency grid conditions.
- Interconnection Type – The CSP will indicate if the generator is interconnected to allow injections onto the transmission and distribution system. The CSP will designate as: “none”, “ISA”, “WMPA”, “NEM”, “PURPA QF” or other category as necessary. If ISA, WMPA, or PURPA QF then the CSP will also provide the appropriate PJM reference to the generator and the associated amount of injection rights.
- The CSP shall report the following battery attributes used as an On-Site Generator at the location
 - Max Output – CSPs shall provide PJM with the kilowatt output that the battery will use for PJM Demand Response load reduction.
 - Battery Capacity (kW 1C) – CSPs shall provide PJM with the maximum kilowatt discharge capability in one hour.
 - Vintage – CSPs shall provide PJM with the year the battery was manufactured.
 - Chemistry – CSPs shall indicate the type of battery technology. Chemistry types are: Lithium-Ion, Lithium-Air, Lithium-Metal, Lithium-Sulfur, Lead Acid, Zinc-Ion, Sodium-Ion, Sodium-Metal Halide, Magnesium-Ion, Magnesium-Lithium Hybrid, Zinc-Manganese Oxide, Vanadium-Redox Flow, Zinc-Polyiodide Flow and, Organic Aqueous Flow.
 - Type – CSPs shall indicate the installation setup for the battery. Types are: Electric Vehicle, PV system and, Stand alone.
- Economic registrations must have the same EDC, LSE, Transmission zone and Pricing point where each location is defined as a unique EDC account number and may be included on the registration subject to aggregation rules in this Manual. Emergency registrations, Economic Regulation Only registrations, and Economic registrations for Residential customers that do not participate in the Day-ahead Market must have the same EDC and Transmission zone.
- If the CSP has an Economic Regulation Only registration then the Economic registration will only allow same location(s) to participate in the Energy Market (“Economic (Energy Only)” in chart above) and they will not be permitted to participate in the SR or SecR market.
- If the CSP has an Economic registration with any certified Ancillary Service (SR, SecR or Reg) then the Economic Regulation Only registration may not be submitted.
- Economic Regulation Only CSPs must be able to manage regulation for the location whether or not the location has been called to provide capacity during an emergency or

pre-emergency situation or is providing a load reduction as an economic resource in the energy market.

- Demand Resources may be registered simultaneously as Economic Load Response Resources and Emergency or Pre-Emergency Load Response Resources.
- Demand Resources may switch CSPs. The CSP registering the switching Demand Resource shall provide PJM with the registration information of the resource. Registrations may only be submitted when there is an effective contract with the customer for the term and product on the registration. CSPs shall check their records to ensure they have an effective contract to support the registration and contact the customer as appropriate before they submit the registration. PJM treats the switching as a new registration. If the current registration is a full Emergency or full Pre-Emergency registration and the Delivery Year has begun, the new registration is denied. Both new and current CSPs are notified by PJM of the switch and are given 5 business days to affirm they have a valid contract with the end-use customer for the term and product as included on their registration and notify PJM through the appropriate system that the customer has affirmed the contract. After 5 business days, if only one CSP has affirmed their registration in the appropriate PJM system, that CSP's registration continues and the other registration is terminated as soon as possible. If both CSPs have affirmed their registration, both registrations are terminated as soon as possible. In order to accommodate Day-ahead Load Response the switch or termination becomes effective at 00:01 of the third business day after the previous registration is terminated or deemed terminated by PJM. The previous registration will remain active for the sole purpose of settlement of load reductions that occurred before the switch became effective.
- Demand Resources intending to run an On-Site Generator in support of local load represents to PJM that it holds all applicable environmental and use permits for running those generators by submitting a registration. Continuing participation is deemed as a continuing representation by the owner that each time its On-Site Generator is run it complies with all applicable permits, including any emissions, run-time limit or other constraint on plant operations that may be imposed by such permits.
- CSPs with an On-Site Generator with interconnection rights to participate in the wholesale markets with injections onto the grid through an ISA or WMPA shall:
 - Inform PJM that the On-Site Generator will participate as DR to offset load through existing DR market rules and participate as a generation resource with injections as defined by generation market rules.
 - Install and maintain telemetry at the point of interconnection and the On-Site Generator, as outlined in PJM Manual 14D: Generator Operational Requirements.
 - Request CBL review if the generator will participate as an Economic DR resource in the energy market. This is to ensure the load reductions from the On-Site Generator can be quantified separately from generator injections onto the grid. Load reductions done in order to inject power onto the grid are considered part of normal operations and therefore not eligible for Economic DR settlements.

- Manage the DR offers to reduce load and/or Generation offers to inject power in the wholesale markets based on the actual generator capability. CSPs will make sure that the total offer amount for the modelled resources will not exceed the capability for the generator. All regulation offers will be made through the DR modelled resource or as otherwise approved by PJM.
- A CSP shall not submit a request to be an Emergency resource (instead of Pre-Emergency) unless it has done its due diligence to confirm that the Demand Resource meets the requirements and has obtained from the end-use customer documentation supporting the exception request. The CSP shall provide PJM with a copy of such supporting documentation within three (3) business days of a request therefor. Failure to provide such supporting documentation by the deadline shall result in the Demand Resource being classified as a Pre-Emergency resource.
- Emergency and Pre-Emergency resource offer price may not exceed the following:
 - 30 minute lead time: \$1,000/MWh, plus the applicable Primary Reserve Penalty Factor from the first step of the demand curve, minus \$1.00.
 - Approved 60 minute lead time: \$1,000/MWh, plus the applicable Primary Reserve Penalty Factor from the first step of the demand curve divided by 2.
 - Approved 120 minute lead time: \$1,100/MWh.
 - Please refer to Section 2.8 of this Manual for the business rules regarding when Emergency or Pre-Emergency resources are eligible to set LMP.

10.2.2.1 Dispatch Groups

- Economic Demand Resource registrations may be associated with a dispatch group. The dispatch group will allow the CSP to have one Real-time or Day-ahead Energy Market bid for the entire dispatch group.
- The dispatch group must have registrations with the same Transmission Zone and energy market pricing point.
- Registrations that participate in ancillary service markets will not be permitted to use a dispatch group unless approved by PJM.
- Registrations cannot be in a dispatch group and as a standalone registration. This will ensure that each registration is only available to bid once in the market and avoid duplications.
- Registrations must be confirmed before they may be added to a dispatch group.
- Registrations that clear in the Day-ahead Market are not allowed to be assigned to a dispatch group on same day it cleared in Day-ahead Market. If the CSP does try to assign the registration to a dispatch group on such day then PJM will remove the registration from the dispatch group because this may create a conflict between the single registration that cleared in the Day-ahead Market and the dispatch group that may be dispatched in the Real-time Market for same Operating Day.

- The CSP is responsible for ensuring that at least one registration is in a dispatch group when bid in the Day-ahead or Real-time Energy Market through the appropriate PJM system.

10.2.2.2 Customer Usage Information Authorization

To assist CSPs in obtaining the electric usage information of the end-use customer the following Customer Usage Information Authorization form has been developed.



Customer Usage Information Authorization

for PJM Load Response Programs (“Authorization”)

_____, the end-use customer, (“Customer”) hereby authorizes _____, and _____, its electric distribution company(ies) (“EDCs”), to release its electric usage information, including hourly or sub-hourly usage history (kWh/kW), EDC loss factors, and peak load contribution assignments for the current delivery year and the upcoming delivery year, if known, to _____, the curtail service provider (“CSP”), which has been or may be retained by Customer to act on its behalf in the PJM Load Response Programs. Customer’s EDCs and end-use sites are identified on Attachment A-1 and A-2 hereto, which are incorporated herein by reference.

1. Customer’s contact information for purposes of its participation in the PJM Load Response Programs is as follows:

Customer Name: _____

Contact Person: _____

Mailing Address: _____

City State Zip Code

Telephone Number: _____

Fax Number: _____

Contact Person’s Email Address: _____



2. Customer hereby advises CSP that it deems the information obtained pursuant to this Authorization to be confidential and therefore requests that such information not be divulged to any third party, except as required to participate in the PJM Load Response Programs.

3. This Authorization shall terminate as follows (mark ONE of the options below):

____ This Authorization shall be perpetual and shall not terminate unless written notice is provided to CSP at least ____ days in advance.

____ This Authorization shall automatically terminate on _____, with no further notice to CSP being required.

4. I understand that termination of this Authorization will not affect any action that CSP took in reliance on this Authorization before it automatically terminated or before CSP received Customer's written notice of termination.

5. The undersigned affirms that they have authority to execute this Authorization on behalf of Customer.

IN WITNESS WHEREOF, Customer executes this Authorization to be effective as of the date written below.

Customer: _____

By: _____

Print Name

Title

Signature

Date

ATTACHMENT A-1

LIST OF SITES FOR WHICH EDC, _____, HAS AUTHORIZATION TO PROVIDE ELECTRIC USAGE INFORMATION TO CSP

Account Number(s):

Service Address:

Account Number(s):

Service Address:

Account Number(s):

Service Address:

Account Number(s):

Service Address:

10.2.3 PJM Activities

The following business rules apply to PJM activities:

- PJM will, as necessary, propose or determine an alternative CBL calculation together with supporting analysis. The process for determining an alternative CBL is set forth below.
- PJM will confirm with the appropriate LSE and EDC whether the load reduction is under other contractual obligations. The EDC and LSE have ten (10) business days to respond or PJM assumes acceptance.
- Other contractual obligations may not preclude participation, but may require special consideration by PJM such that appropriate settlements are made within the confines of the existing contract.
- PJM will inform the CSP, EDC and LSE of the demand resource's acceptance into the program as appropriate.
- PJM will create LSE negative DEC bids for DR that clears in the Day-ahead Market for dispatch group based on the registration DR load reduction capability. PJM will create LSE negative DEC bids for a DR that clears in Day-ahead Market for registrations based on the amount that cleared in Day-ahead Market. A negative DEC bid is the same as an offer to sell which is done to minimize the impact of the load reduction on the LSE's Day-ahead Energy Market position.

10.2.4 Electric Distribution Company (“EDC”) and Load Serving Entity (“LSE”) Activities

EDCs have ten (10) business days to review all registrations and verify the EDC account number, Zone, Pricing point, Line losses, existence of EDC interval meter if applicable, accuracy of Peak Load Contribution (PLC), and whether or not the customer may or may not participate based on the Relevant Electric Retail Regulatory Authority orders, ordinances or resolutions. If the information provided by the CSP is incorrect the EDC may deny the registration. Once the registration is denied, the CSP may correct the inaccurate information and resubmit the registration only to the EDC, as appropriate.

LSEs have ten (10) business days to review registrations, except Pre-Emergency and Emergency registrations and Economic Regulation Only registrations, and verify whether or not the customer may or may not participate based on the Relevant Electric Retail Regulatory Authority orders, ordinances or resolutions. LSEs will also review the registration to determine if the load reductions for the location(s) are subject to an LSE contractual obligation. If the information provided by the CSP is incorrect the LSE may deny the registration. Once the registration is denied, the CSP may correct the inaccurate information and resubmit the registration only to the LSE, as appropriate.

10.2.5 CBL Certification Process

All Economic registrations, except Economic Regulation Only registrations, should go through the CBL certification process to ensure that the CBL used to predict the customer load and therefore, determine the quantity of each hourly load reduction, is reasonably accurate and non-biased. All registrations should use a CBL with a Relative Root Mean Square Error (RRMSE) no greater than 20% unless otherwise approved by PJM. Registrations with a RRMSE greater than 20% based on hourly load data provided in the registration process are considered variable load customers.

CBL certification is performed by the CSP prior to registration submission. CSPs should always calculate an RRMSE for the standard CBL defined in the Tariff. An alternative CBL may be requested if the alternative CBL is more accurate than the standard CBL and has an RRMSE less than or equal to 20%.

The RRMSE is based on sixty (60) most recent days of continuous hourly load data where the most current load data should be sixty (60) days or less than the date the RRMSE is calculated unless otherwise approved by PJM.

PJM and the CSP shall have thirty (30) days from the day the alternative CBL proposal is received by the other party to agree on a proposed alternative CBL calculation. If the parties agree on an alternative CBL calculation, then the agreed upon CBL calculation shall be effective from the date of the registration.

If PJM and the CSP do not agree on an alternative CBL calculation within thirty (30) days, then PJM shall determine the CBL calculation within twenty (20) days of the expiration of the prior thirty (30) day period. The CBL established by PJM shall be binding on the parties unless agreement on an alternative CBL is reached before the end of the twenty (20) day period.

The process for determining the appropriate CBL shall not delay the registration, provided that the alternative CBL established shall be used for all applicable energy settlements.

PJM shall periodically publish herein alternative CBL calculations established through this process.

The RRMSE calculation is performed as follows unless otherwise approved by PJM:

- To perform the RRMSE calculation, daily CBL calculations are first performed for the CBL method using hours ending 14 through hours ending 19 unless otherwise approved by PJM as the simulated event hours for each of the sixty (60) non-event days according to the CBL method rules.
- Actual Hourly errors are calculated by subtracting the CBL hourly load from the actual hourly load for each of the simulated event hours of the non-event day.
- The Mean Squared Error (MSE) is calculated by summing the squared actual hourly errors and dividing by the number of simulated event hours.
- The Average Actual Hourly Load (AAHL) is the average of the actual hourly load for each of the simulated event hours.
- The RRMSE is calculated by taking the square root of the MSE then divide that quantity by the AAHL.

10.3 Economic DR Energy Market Participation

Qualified CSPs may offer the load reductions of demand resources into the Day-ahead and/or Real-time Energy Market pursuant to the PJM Manuals, Markets Gateway User Guide, and the following rules and requirements.

CSPs that would like to participate in the Energy Market shall submit a bid for each Demand Resource (registration or dispatch group) which includes:

- Transmission zone and pricing point based on where the Demand Resource is located and the associated pricing point used to settle the load in the retail market and/or as defined by PJM.
- Demand Resource market type which determines how the bid is utilized by the Energy Market:
 - Day-ahead Market – If an hour clears in the Day-ahead Market then the Demand Resource should respond with associated MW. PJM does not dispatch in Real-time for hours that clear in Day-ahead Market.
 - Real-time Market (Balancing) – The Demand Resource should follow the Real-time dispatch signal for the MW that have been dispatched.
 - Both:
 - If specific hour clears in Day-ahead Market then the Demand Resource should respond with associated MW. PJM does not dispatch in the Real-time market for hours that clear in the Day-ahead Market.
 - If an hour does not clear in Day-ahead Market then the hour is eligible to be dispatched in the Real-time Market.
- Hourly Incremental Offer curve (minimum increments of 0.1MW) may represent up to ten (10) combinations of MW load reduction and offer price. This determines the price offered

into the Day-ahead Market for respective MW amount in each hour and the price offered for dispatch in the Real-time Market.

- CSPs may only submit an energy offer greater than \$1,000/MWh for an Economic DR resource if the CSP has verified that the end use customer's incremental cost for each offer is greater than \$1,000/MWh pursuant to the DR Validation Process.
 - The offer must be equal to or less than the end use customer(s)' incremental cost.
 - CSP verified energy offers greater than \$1,000/MWh and less than or equal to \$2,000/MWh are eligible to be used in the calculation of the applicable LMP as defined in the Tariff.
 - Energy offers with CSP verified incremental costs greater than \$2,000/MWh are compensated through Operating Reserves.
- Any hourly changes made on the Offer Updates or Hourly Updates screens in Markets Gateway supersede the values on the Offers and Parameters pages.
- Changes made on the DR Updates pages of Markets Gateway are not carried over into the next day.
- The hourly availability which determines the specific hours when the Demand Resource may be cleared in the Day-ahead Market and the associated MW volume that is available to clear for each hour. This also determines the specific hours when the Demand Resource may be dispatched in the Real-time Market and the associated MW volume that may be dispatched for each hour.
- Economic Minimum and Maximum MW used to determine the dispatch of Demand Resources in the Real-time Energy Market can be changed up to 65 minutes before the operating hour by the CSP. For example, hourly updates for hour ending 15:00 which starts at 14:00 can be changed up to 12:55 during the same day.
- Shut down costs, for each period are defaulted to zero if not submitted. Shutdown costs are expressed in dollars, and represent the fixed cost associated with committing a Load Response resource. Shutdown costs may not be updated for any hours in which the resource received a commitment in the Day-ahead or Real-time Market.
- Minimum down times for which the load reduction must be committed are defaulted to zero if not submitted. Minimum down time is expressed as a number of hours, and represents the minimum number of continuous hours for which a Load Response bid must be committed in the Day-ahead Market or dispatched in the Real-time Market. Hourly differentiated minimum down times can be specified but are only for use during Real-time commitment and dispatch.
- Load Response bids in the Day-ahead Market or hourly MW availability in the Real-time Market should exclude losses (transmission zone losses and share of 500 kV losses). This means bids should be based on expected retail metered load reductions grossed up for line losses.
- Day-ahead Energy Market bids and associated information must be submitted based on overall Energy Market rules and associated time line as described in this Manual.

- Demand Resources are eligible to set Day-ahead and Real-time Energy market prices if selected as the marginal resource.

Demand Response Validation Process

CSPs must validate the end use customer(s) incremental costs for Economic DR energy offers in accordance with the following provisions before it can be used for dispatch and in the calculation of LMP:

- The CSP must provide a summary of the incremental cost on a \$/MWh for each cost category in the appropriate PJM system. Supporting documentation that explains and quantifies the end-use customer's incremental costs included in the summary must also be submitted.
 - The end-use customer's incremental costs shall include the quantifiable cost incurred for not consuming electricity when dispatched by PJM, such as wages paid without production, lost sales, damaged products that cannot be sold, or other incremental costs as approved by PJM.
 - Incremental costs may not include shutdown costs.
 - Incremental costs should reflect those incurred during the energy offer period. The CSP shall review and update the incremental cost on a daily basis when energy offers submitted are greater than or equal to \$1,000/MWh.

10.3.1 Economic Load Response Resource Composite Energy Offer Screening Process for Composite Offers more than \$1,000/MWh

Before the components of a Fast-Start Capable Economic Load Response resource are considered in the calculation of LMPs, PJM uses a screening process to verify the reasonableness of each Composite Energy Offer in excess of \$1,000/MWh calculated at the submitted applicable Economic Maximum. In the event an hourly Economic Maximum has been submitted, this will be used as the applicable Economic Maximum; otherwise, the submitted Daily Offer will be used.

In order for that Composite Energy Offer to be eligible to set the applicable Locational Marginal Price the Economic Load Response Participant must validate such costs with the end use customer(s), notify PJM of verified Shutdown Cost, and upon request, submit to PJM supporting documentation demonstrating that the end-use customer's costs in providing such demand reduction are greater than \$1,000/megawatt-hour in accordance with the following provisions:

1. The supporting documentation must explain and support the quantification of the end-use customer's incremental costs and shutdown costs; and
2. The end use customer's incremental and shutdown costs shall include quantifiable cost incurred for not consuming electricity when dispatched by PJM, such as wages paid without production, lost sales, damaged products that cannot be sold, or other incremental costs as defined in the PJM Manuals or as approved by PJM.

If upon review of the supporting documentation for the Economic Load Response Participant's, PJM determines that the offer was not reasonably supported by incremental and shutdown costs greater than or equal to \$1,000/MWh, PJM may refer the matter to the MMU and/or FERC Office of Enforcement for investigation.

10.3.2 Determination of LMPs for Economic Load Response Resources with Composite Energy Offers greater than 1,000/ MWh and equal to or below \$2,000/MWh

If the shutdown cost is deemed not reasonable, adjustments are made to ensure the resulting Composite Energy Offer is no less than \$1,000/MWh or the verified offer components as described in the Operating Agreement, Schedule 1, Section 2.4 for Real-time and Section 2.4A for Day-ahead Markets.

The chart below describes how the Composite Energy Offer may be adjusted in the event the shutdown cost exceed (fail) or do not exceed (pass) the reasonably expected cost for the determination of LMPs.

Scenario	Submitted Composite Energy Offer at EcoMax (\$/MWh)	Submitted Incremental Energy Offer ("IEO")	Reasonability Test Results	Composition of Composite Energy Offer*	Adjustment and/or Offer Capping
			Submitted Shutdown Cost		
1	≤ \$1,000	≤ \$1,000	N/A	IEO + ASD	No Offer Verification Trigger
2	\$1,000 < Offer ≤ \$2,000	≤ \$1,000	Pass	IEO + ASD	None
3	\$1,000 < Offer ≤ \$2,000	≤ \$1,000	Fail	IEO + Adjustment (If needed)	Cap offer at \$1000; ASD may be included to cap offer at \$1,000
4	\$1,000 < Offer ≤ \$2,000	> \$1,000	Pass	IEO + ASD	None
5	\$1,000 < Offer ≤ \$2,000	> \$1,000	Fail	IEO	Incremental is verified above \$1000, no additional cost are added

*The Shutdown Cost included in a Composite Energy Offer will be at their amortized value and ASD represents amortized Shutdown Cost.

10.3.3 Determination of LMPs for Composite Energy Offers Greater than \$2,000/MWh

If an economic load response submits a Composite Energy Offer with a maximum segment that exceeds \$2,000/MWh, the components that make up the offer are verified for reasonableness as described in Operating Agreement, Schedule 1, Section 6.4.3A and Section 10.3.1 of this manual. Based on the results of the reasonableness verification, adjustments are made to ensure the resulting Composite Energy Offer is no greater than \$2,000/MWh as described in the Operating Agreement, Schedule 1, Section 2.4 for Real-time and 2.4A for Day-ahead Markets.

The chart below describes scenarios of submitted composite energy offers and how they will be adjusted should shutdown cost exceed (fail) or not exceed (pass) the reasonably expected cost for the determination of LMPs.

Scenario	Submitted Composite Energy Offer at EcoMax (\$/MWh)	Submitted Incremental Energy Offer ("IEO")	Reasonability Test Results	Composition of Composite Energy Offer*	Adjustment and/or Offer Capping
			Submitted Shutdown Cost		
1	> \$2,000	≤ \$1,000	Pass	IEO + ASD	Cap Composite Energy Offer at \$2,000, adjust ASD down, until the Composite Energy Offer equals \$2,000.
2	> \$2,000	≤ \$1,000	Fail	IEO + adjustment (If needed)	Cap Composite Energy Offer at \$1,000; include ASD up to submitted Shutdown Cost, until Composite Energy Offer equals \$1,000
3	> \$2,000	\$1,000 < Offer ≤ \$2,000	Pass	IEO + ASD	Cap Composite Energy Offer at \$2,000, adjust ASD down, until the Composite Energy Offer equals \$2,000.
4	> \$2,000	\$1,000 < Offer ≤ \$2,000	Fail	IEO	None

*The Shutdown Cost included in a Composite Energy Offer will be at their amortized value and ASD represents amortized Shutdown Cost.

10.3.4 Net Benefits Test to determine Net Benefits Threshold

The Net Benefits Threshold (NBT) is the point on the aggregate supply curve at which the participation of DR resources results in a greater overall savings to the load on the system compared to the DR resources remaining on the system as load. PJM shall compute the NBT monthly as described below. PJM shall post the NBT and associated supporting information for each month by the 15th of the prior month on pjm.com. CSPs only receive compensation for Demand Resources cleared in Day-ahead Market or dispatched by PJM in the Real-time Market if the applicable LMP is greater than or equal to the monthly NBT.

The Net Benefits Test is executed using the following steps:

- Step 1: Retrieve generation offers from the same calendar month of the prior calendar year for which the calculation is being performed. These generation offers use market-based price offers to the extent available, and cost-based offers to the extent market-based price offers are not available.

Note:

To the extent that generation offers are unavailable from historical data due to the addition of a Zone to the PJM Region, PJM shall use the most recent generation offers that best correspond to the characteristics of the calendar month for which the calculation is being performed, provided that at least thirty (30) days of such data is available. If less than thirty (30) days of data is available for a resource or group of resources, such resource[s] shall not be considered in the Net Benefits Test calculation.

- Step 2: Adjust a portion of each prior-year offer representing the typical share of fuel costs in energy offers in the PJM Region for changes in fuel prices based on the ratio of the reference month spot price to the study month forward price. To accomplish this adjustment, spot fuel prices for the reference month are compared to forward prices for the study month. First, the spot prices for representative PJM fuels are averaged together for the reference month.
 - For natural gas, the Henry Hub price is used, since natural gas prices tend to move in concert with Henry Hub. For oil, the New York Harbor price for No. 2 fuel oil is used. For coal adjustments, PJM has determined a mix of 20% Powder River Basin, 50% Northern Appalachia, and 30% Central Appalachia coal to be representative of the fuel used by PJM resources. Representative coal prices are combined in a weighted average to form a representative RTO coal price for the reference month.
 - Forward prices are used to determine a similar representative price for the study month. These two values are used as a ratio. If the representative price from June 2010 was \$4.10, and the forward price for June 2011 was \$4.51, then the ratio is 1.1 (prices were up 10%, or June 2011's price is 110% of June 2010's price.)
 - The offers of generation units are then be adjusted by this scaling factor. The price of fuel typically represents 80 to 90 percent of a generator's offer with the remainder being variable operations and maintenance costs and other uncertainties. As such, 85 percent of each generator's offer is scaled by the fuel scalar.
 - Where generators offer multiple points on a curve, each point on the curve is adjusted in this manner.
- Step 3: Combine the offers to create daily supply curves for each day in the period.
- Step 4: Average the daily curves for each day in the month to form an average supply curve for the study month.
- Step 5: Use a non-linear least squares estimation technique to determine an equation that reasonably approximates and smooths the average supply curve. PJM shall publish the details of the equation and parameters each month along with the NBT results.

- Step 6: Determine the net benefit level as the point at which the price elasticity of supply is equal to 1 for the estimated supply curve equation established in Step 5.

10.4 Demand Resource Metering and Settlement Data Requirements

The settlements submitted to PJM by CSPs must conform to the following requirements for data, including metered data, and CBL calculations. All settlement related calculations for Economic and Emergency Demand Resources are provided in PJM Manual 28: Operating Agreement Accounting.

10.4.1 Metered Data

Demand Resources must be equipped with interval meters recording electrical usage at the EDC account level. The interval of data collection must be sufficient to provide PJM with hourly, one minute or real time load data as applicable for the wholesale market. Residential Direct Load Control (RDLC) aggregates may have interval meters installed on a statistical sample of EDC accounts per PJM Manual 19: Load Forecasting and Analysis, Attachment C and subject to PJM approval.

Any CPS submitting a settlement for load reduction made in the Energy Market that is not metered directly by PJM is responsible for uploading the appropriate meter data (as defined in this Manual) into PJM's DR Hub system within sixty (60) days of the reduction.

If the meter data files are not received within sixty (60) days, no payment for participation is provided.

Load data must be provided for all hours of the day and for all days necessary for PJM to calculate the CBL for settlements or to measure compliance as necessary.

When On-Site Generation is used solely to enable the Participant to provide demand reductions then the CSP may provide qualified meter generation output data, upon approval by PJM, from the On-Site Generator for each hour of the event day instead of actual load metered data. Provision of hourly meter data from the On-Site Generator is deemed a certification by the CSP that the On-Site Generator was not used for any purpose other than to support the load reduction during the event day.

If the On-Site Generator is used on a regular basis for normal operations then the CSP may provide qualified meter data from the On-Site Generator for each hour of the event provided the amount of generation run to provide Economic Load Response can be quantified in a manner that is acceptable to PJM. For example, if a five (5) MW On-Site Generator that normally provides three (3) MW boosts its output to five (5) MW in response to LMPs the CSP is eligible to receive a demand response energy settlement for the additional two (2) MW of output.

Meter data is forwarded to the EDC upon receipt, and these parties have ten (10) business days to review accuracy and provide feedback to PJM.

Objection by the EDC to the Meter Data shall be clearly set forth in the Comments related to the Settlement Data. The CSP shall correct and re-submit the Settlement Data within two (2) business days. The objecting EDC shall have five (5) business days to review the re-submitted Settlement Data or PJM assumes acceptance.

All load reduction data is subject to PJM Market Monitoring Unit audit.

10.4.2 Customer Baseline Load (CBL)

The following tables list all available CBLs and represent the different parameters used for each calculation. The 3 Day Type with Symmetric Additive Adjustment (SAA) represents the standard, Tariff defined CBL which is utilized for most non-variable economic demand resources and is set forth in section 3.3A.2 of the PJM Tariff. The alternative CBLs on the list have been created over time to provide options, especially for variable load customers that have an RRMSE above 20%.

PJM makes available the CBL calculations to the appropriate EDC and LSE for optional review.

The CSP shall inform PJM, of any significant change to the Demand Resource's operations that increases or decreases the Demand Resource's CBL. A significant incremental change is defined as any operational or physical change to the Demand Resource's facilities that adjusts more than half the hours in the Demand Resource's CBL by at least 20% for more than twenty (20) consecutive days. PJM may require and approve such adjustments to the CBL as are necessary to reflect the significant incremental change.

Parameter/CBLs	3 DayTypes		3 Day Types with SAA (Tariff Default)		3 Day Types with WSA	
	Weekdays,	Sat ,Sun/Hol	Weekdays	Sat,Sun/Hol	Weekdays	Sat, Sun/Hol
DayType	Average	Average	Average	Average	Average	Average
Calculation¹	Average	Average	Average	Average	Average	Average
CBL Basis Window²	5	3	5	3	5	3
CBL Basis Window Limit³	45	45	45	45	45	45
Start Selection From Days Prior to Event⁴	1	1	1	1	1	1
Exclude Previous Curtailment Days⁵	Y	Y	Y	Y	Y	Y
Exclude Long/Short DST Days⁶	N/A	Y	N/A	Y	N/A	Y
Exclude Avg. Event Period Usage Less than Threshold⁷	25%	25%	25%	25%	25%	25%
Exclude # of Low Usage Days⁸	1	1	1	1	1	1
Use Previous Curtailment if CBL Basis Window incomplete⁹	Yes	Yes	Yes	Yes	Yes	Yes
Use Highest or Recent Previous Curtailment Day¹⁰	Highest	Highest	Highest	Highest	Highest	Highest
Adjustments¹¹	None	None	Symmetric Additive	Symmetric Additive	Weather Sensitive	Weather Sensitive
Allow Negative Adjustments¹²	N/A	N/A	Yes	Yes	Yes	Yes
Adjustments Start (HE0-x)¹³	N/A	N/A	4	4	0	0
Adjustment Basis Hours¹⁴	N/A	N/A	3	3	Event Hours	Event Hours

Parameter/CBLs	7 DayTypes	7 Day Types with SAA	MBL(Max Base Load) ^A		Metered Generation ^B
			Weekdays	Sat,Sun/Hol	
DayType	Mon,Tue,Wed,Thu,Fri,Sat,Sun/Hol	Mon,Tue,Wed,Thu,Fri,Sat,Sun/Hol	Weekdays	Sat,Sun/Hol	N/A
Calculation ¹	Average	Average	Average	Average	N/A
CBL Basis Window ²	3	3	5	3	N/A
CBL Basis Window Limit ³	60	60	45	45	N/A
Start Selection From Days Prior to Event ⁴	1	1	1	1	N/A
Exclude Previous Curtailment Days ⁵	Y	Y	Y	Y	N/A
Exclude Long/Short DST Days ⁶	Y	Y	N/A	Y	N/A
Exclude Avg. Event Period Usage Less than Threshold ⁷	25%	25%	25%	25%	N/A
Exclude # of Low Usage Days ⁸	0	0	0	0	N/A
Use Previous Curtailment if CBL Basis Window incomplete ⁹	Yes	Yes	Yes	Yes	N/A
Use Highest or Recent Previous Curtailment Day ¹⁰	Highest	Highest	Recent	Recent	N/A
Adjustments ¹¹	None	Symmetric Additive	None	None	N/A
Allow Negative Adjustments ¹²	N/A	Yes	N/A	N/A	N/A
Adjustments Start (HE0-x) ¹³	N/A	4	N/A	N/A	N/A
Adjustment Basis Hours ¹⁴	N/A	3	N/A	N/A	N/A

Parameter/CBLs	Same Day (3+2) ^D	Match Day (3 Day Average) ^E
DayType	N/A	N/A
Calculation ¹	Average	Average
CBL Basis Days ²	N/A	3
CBL Basis Day Limit ³	N/A	45
Start Selection From Days Prior to Event ⁴	N/A	1
Exclude Previous Curtailment Days ⁵	N/A	Y
Exclude Long/Short DST Days ⁶	N/A	Y
Exclude Avg. Event Period Usage Less than Threshold ⁷	N/A	N
Exclude # of Low Usage Days ⁸	N/A	0
Use Previous Curtailment if CBL Basis Window incomplete ⁹	N/A	Y
Use Highest or Recent Previous Curtailment Day ¹⁰	N/A	Recent
Adjustments ¹¹	None	None
Allow Negative Adjustments ¹²	N/A	N/A
Adjustments Start (HE0-x) ¹³	N/A	N/A
Adjustment Basis Hours ¹⁴	N/A	N/A

Notes:

A) Max Base Load (MBL) - The MBL CBL for weekdays shall be the average of the daily minimum hourly loads during the event hours over the five (5) most recent weekdays preceding the load reduction event within the forty-five (45) calendar day period preceding the load reduction event. The daily minimum load calculation must be based on a minimum of three (3) hours. If the number of event hours is less than three (3), then the daily minimum load calculation uses the following hours of the same calendar day: hour prior to event, event hour(s), hour after event, in that order until three (3) hours are attained. Exceptions: use only

event hours in the same calendar day if the start of the event is sometime between 21:00 and midnight OR if the end of event is sometime before 03:00.

B) Metered Generation - The use of this methodology must be approved by PJM. Historical data is required showing that the unit does not normally run or is not normally active. If the data indicates that the unit runs normally, is active, or if the unit is a Cogen operation then another CBL methodology may be required to ensure economic dispatch activity is isolated from normal operations.

C) Same Day (3+2) - The Average of three (3) hours prior to the event (after skipping the first hour before the event) and two (2) hours after the event (after skipping the first hour after the event) to determine the CBL that is used for all event hours. If there are multiple non-continuous events during the same day PJM uses the earliest three (3) hours and last two (2) hours from the same day. PJM uses hours available on the Operating Day to calculate the CBL, where at least three (3) hours are used. A resource may not participate in Hour Ending (HE) 1, 2, 3, 23, 24 to ensure there are enough hours to calculate the CBL. The CSP ensures there is no significant pre-event or post-event change in operations during the operating day that will increase the load in the hours selected for the CBL beyond what would have normally occurred. If the load is shifted to one of the 3 + 2 hours and therefore significantly increases the CBL, the CSP may not use this CBL for such resource.

D) Match Day (3 Day Average) - Determines the event day non-event hours or “comparison hours”. Comparison hours are all hours in the Operating Day except for the hour before the earliest event hour through the hour after the last event hour. For example, if an economic DR resource is dispatched HE12 – HE14 and then re-dispatched in HE17-HE20 the comparison hours are HE1- HE10 and HE22-HE24 (13 comparison hours in total). For each non-event day within the CBL Basis Day limit:

(1) Take the difference between each comparison hour from the event day and the same hour in each day in the CBL Basis Day Limit to determine the hourly difference for each comparison hour for each day.

(2) Square all the hourly differences for each day and then sum the squared differences to determine the daily differences.

(3) Select the three (3) days from the CBL Basis Day Limit with the smallest daily differences to determine the CBL Days. Average each of the event hours across the three (3) CBL Days to determine the CBL.

Additional Notes:

1. Calculation - Defines whether to use median or average to calculate the CBL after the CBL Basis Window has been defined and high and low usage days are excluded.

2. CBL Basis Days - The set of days that serve as representative of end-use customer's typical usage. If the number of days specified is five (5), then after all exclusions (e.g.: before excluding event days and Low Usage Days), the set contains five (5) days.
3. CBL Basis Day Limit - Defines the limit on the number of historical calendar days used to select the CBL Basis Days (e.g.: If forty-five (45) this means that the CBL days must be selected from the prior forty-five (45) calendar days). This ensures recent information is used to predict future consumption.
4. Start Selection from Days before Event Day - Determines the most recent historic CBL day to select (e.g. if one (1) then select the most recent day with same daytype, if two (2) then skip the most recent day with same daytype and select the next day with same daytype).
5. Exclude Previous Curtailment Days. If this is set to "Y", exclude all previous curtailment days. Previous Curtailment Days are previous economic settlement days that include at least one (1) hour in pending or confirmed status.
6. Exclude Long/Short DST Days - If this is set to "Y", then any long/short DST day is excluded from the CBL Basis Window.
7. Exclude Avg. Daily Event Period Usage Less than Threshold - If the Average Daily Event Period Usage for the CBL day selected is less than the threshold indicated, then that day is excluded from the CBL Basis Window.
8. Exclude # of Low Usage Days - If the CBL Basis Days is set to five (5) and this switch is set to one (1), then the one (1) day with the lowest Average Daily Event Period Usage is excluded from the CBL calculation.
9. Use Previous Curtailment Day if CBL Incomplete - If this is set to "Y", and if the CBL is unable to attain the minimum number of days required to calculate the CBL, then Previous Curtailment Days are used as CBL Basis Days until such minimum is attained. If this is set to "Y", then Exclude Previous Curtailment Days must also be set to "Y".
10. Use Highest or Recent Previous Curtailment Day - This is required if the Use Previous Curtailment Day if CBL Incomplete is set to "Y". "Highest" means that the model ranks Previous Curtailment Days based on event period usage within the CBL Basis Day Limit and add them to the CBL Basis Days in descending order until the CBL Basis Days contains the minimum number of days required to calculate CBL. "Recent" means that the model starts adding days to the CBL Basis Days starting with the Most Recent Curtailment Day that was excluded until the CBL Basis Days contains the minimum number of days required to calculate CBL.
11. Symmetric Additive Adjustment – This is CBL average usage for Event Day divided by Adjustment Basis Hours for same hours.
12. Allow Negative Adjustments - If this is set to "Y", then adjustments may be positive or negative. Otherwise, adjustments are always greater than zero.
13. Adjustment Start (HE0-x) - This defines the starting point for the hour(s) to be used in calculating the adjustments. If the event starts with HE13 and the Adjustment Start is four (4), then HE9 is the first hour used to calculate adjustments.

14. Adjustment Basis Hours. - This determines the total number of hours to use in the adjustment from the Adjustment Start. If the event is on HE13, Adjustment Start is four (4), and Adjustment Basis Hours is three (3), then the adjustment is based on the load from HE9-HE11.

Weather Sensitive Adjustment (WSA)

The WSA Factor Method adjusts the hourly CBL (up or down) to compensate for the average hourly temperature differences between the CBL Basis Days and the temperature of the event hour.

The WSA Factor represents the kW change in load for each degree of temperature change within a specified temperature range. The WSA Factor is the slope of the line that describes the load and temperature relationship at the customer site between two temperature set points. The WSA Factor or slope of the line is obtained by performing a linear or piecewise linear regression analysis on the load and temperature data from the customer site. There should be at least two (2) years of data used in the linear regression analysis to indicate the normal operation of the facility.

Exceptions may be granted by PJM to use less data in cases where the normal operations have changed significantly between years. The analysis data should only include the day types and hours where load reductions are expected. For example, if the customer is only expected to respond during the hours of 08:00 to 18:00 from Monday through Friday during non-holidays, then such historic hours should be used in the regression model.

The hourly CBL Adjustment is obtained by multiplying the WSA Factor by the temperature of the event hour minus the hourly average temperature of the CBL. The hourly average temperature of the CBL is the hourly average of the CBL Basis Days.

Example 1:

- Hourly average temperature of the CBL for Hour Ending 12 = 86°
- Event temperature for Hour Ending 12 = 81°
- WSA Factor = 688 kW/°F
- CBL Adjustment for Hour Ending 12 = Temperature Delta * WSA Factor = (81° - 86°) * 688 kW/°F = -3440 kW

The CBL is adjusted down because the temperature of the event day is lower than the average hourly temperature of the CBL Basis Days

A simple linear regression analysis fits a straight line through the set of points (load and temperature data) in such a way that makes the sum of squared residuals as small as possible. The first and last points of the estimated line are known as the Temperature Set Points. The slope of the line between the two Temperature Set Points is the WSA factor.

A piecewise linear regression analysis fits multiple continuous straight lines through the set of data points (load and temperature data) in such a way that makes each of the sums of squared residuals as small as possible. The piecewise linear regression analysis results in multiple lines with multiple slopes that estimate the load and temperature relationship of the customer site data. The end points of each of the estimated lines are known as the Temperature Set Points. Determining the number of Temperature Set Points can be accomplished by using a Piecewise Linear Regression Break Point algorithm or by data observation at points where the slope of the data appears to change significantly. Either methodology should result in minimizing the sum of squared residuals for each of the estimated lines.

The following table represents the weather station used for each Transmission Zone

Zone	Weather Station Short Name	Weather Station
AECO	ACY	Atlantic City International
AEP	CMH	Port Columbus International
APS	PIT	Pittsburgh International
ATSI	CAK	Akron Canton International
BGE	BWI	Baltimore Washington International
COMED	ORD	Chicago O'Hare International
DAY	DAY	Cox-Dayton International
DEOK	CVG	Cincinnati/Northern Kentucky International
DOM	RIC	Richmond International
DPL	PHL	Philadelphia International
DUQ	PIT	Pittsburgh International
EKPC	SDF	Louisville International-Standiford
JCPL	EWR	Newark International
METED	PHL	Philadelphia International
PECO	PHL	Philadelphia International
PENELEC	JST	Johnstown Airport
PEPCO	DCA	Washington Reagan National

Zone	Weather Station Short Name	Weather Station
PPL	ABE	Allentown Lehigh Valley International
PSEG	EWR	Newark International
RECO	EWR	Newark International

10.4.3 Economic Energy Settlements

The CSP is responsible for providing all necessary information for each EDC account number unless otherwise approved by PJM for settlement and compliance calculations. CSPs are eligible to be paid full LMP for the Registration's or Dispatch Group's reductions, provided that the LMP at the pricing point is at or above the Net Benefits Price and in accordance with PJM Manual 28: Operating Agreement Accounting.

All Registrations or Dispatch Groups must either clear in the Day-ahead Market or be dispatched by PJM in order to be eligible for settlement revenue.

All Registrations or Dispatch Groups are eligible for Make Whole Payments subject to performance. The Make Whole Calculation is detailed in PJM Manual 28: Operating Agreement Accounting, Section 11.2.

All Registrations or Dispatch Groups are subject to Balancing Operating Reserve (BOR) charges for deviations greater than 20% from the PJM Day-ahead or Real-time dispatch instructions.

DR resources may submit bids that are less than the Net Benefits Price but are only paid if appropriate LMP is greater than or equal to NBT.

All settlements that are not submitted within sixty (60) days of the economic event are settled by PJM with 0 kW hourly reductions. BOR is assessed based on the deviations of the stand-alone settlement or Dispatch Group settlement.

All settlements that are still pending, denied or withdrawn after seventy-five (75) days from the economic event are settled by PJM with 0 kW hourly reductions. BOR is assessed based on the deviations of the Registration settlement or Dispatch Group settlement, as appropriate.

Dispatch Group Settlements

To calculate the reductions achieved by the Dispatch Group after an economic event, individual settlements need to be created in DR Hub.

- The CBL needs to be calculated in order to calculate the reductions for the individual Registrations.

- The Dispatch Group economic events are de-aggregated to the Registration level settlement based on the Registrations in the Dispatch Group early in the morning the day after the Operating Day. The individual settlements are submitted by the CSP based on the normal Registration level settlement process.
- The total reduction for the Dispatch Group is calculated once a day as the sum of all the reductions of the settlements. Once all of the settlements in the Dispatch Group reach their final state, the Dispatch Group load reduction is settled.
- The final state for a Dispatch Group economic settlement is achieved when all of the individual settlements within the Dispatch Group achieve the following status:
 - All settlements in Dispatch Group are confirmed.
 - Prior to the 60th day after the event, the CSP may mark the Dispatch Group ready for settlement. Once this has occurred, no further updates to any settlements may be done in the Dispatch Group.
 - On the 61st day after the event and all settlements are either confirmed, withdrawn or expired.
 - Once the 75th day after the event has been reached, the Dispatch Group settlement is sent to settlements regardless of the individual status of any settlements in the group.
- Dispatch Groups that are cleared or dispatched are evaluated at the Dispatch Group level when evaluating BOR. Deviations and BOR are assessed based on the reduction of the Dispatch Group.
- Market Settlements provides a settlement report based on Dispatch Group(s) and not by Registrations.

10.4.4 Economic Energy Settlements Cost Allocation

The cost of Economic Demand Response settlements is allocated to all of the Market Participants with Real-time exports from PJM and LSE's within a zone where zonal LMP is greater or equal to the appropriate Net Benefits Price and as described in PJM Manual 28: Operating Agreement Accounting.

10.4.5 Emergency and Pre-Emergency Energy Settlements

The CSP is responsible for providing all necessary information for each EDC account number unless otherwise approved by PJM for energy settlement. Locations with approved Economic Registrations prior to a Load Management Event that have an economic CBL different than the maximum base load as defined in Section 10 of this Manual will use the associated economic CBL to determine the energy load reduction subject to the following:

- A registration that is already responding to a PJM economic event, where the economic CBL is based on SAA, will use a SAA period prior to an Economic and Emergency or Pre-Emergency event.

- Locations that do not have an approved Economic Registration prior to a Load Management Event and have an economic CBL different than the maximum base load will use the CBL as defined in Section 3.3A.2 of the Tariff and associated SAA as defined in Section 3.3A.2 of the Tariff, unless an alternative CBL is approved pursuant to Section 3.3A.2.01 of the Tariff to determine the energy load reduction.
- Locations on Economic Registrations dispatched in the Real-time Energy Market or cleared in Day-ahead Energy Market that are also included on an Emergency or Pre-Emergency full registration and have been dispatched as part of an emergency event for the same hour (“overlapping dispatch hour”) are compensated for energy based on intra-hour dispatch time for both events. If there is an overlap of intra-hour dispatch intervals then the overlapping intervals are based on emergency energy settlement and cost allocation rules as outlined in this section, and PJM Manuals. Overlapping dispatch intervals use shutdown cost based on what was considered for the economic event and no BOR charges are assessed for deviations from the Real-time dispatch amount or from cleared the Day-ahead amount. Overlapping dispatch intervals for aggregate registrations (multiple locations on the same registration) or Dispatch Groups where locations on Emergency or Pre-Emergency Registrations are not the same as locations on the Economic Registration will have interval economic energy load reduction with associated cleared Day-ahead or Real-time dispatch amounts and/or interval emergency energy load reduction prorated based on load reduction capability provided by the CSP for the location to avoid duplicative energy payment and appropriate BOR charges, as applicable.
- Emergency and Pre-Emergency Registrations dispatched by PJM for less than one (1) hour are eligible for compensation for one (1) hour (i.e.: minimum run time is one (1) hour)
- The CSP may only submit energy settlements for Load Management Events that occur outside of the product specific availability period as defined for each product in the RAA for each Demand Resource type if the CSP confirmed that the customers on the registration did take action to reduce load or the registration reflects the entire group of mass market customers for which an energy settlement is submitted either for all or none of the mass market customers, as approved by PJM. CSP confirmation may include email, voicemail, letter or other form of confirmation that indicates the registration took actions to reduce load in response to PJM dispatch. The CSP may only submit energy settlements for each registration for Load Management Events that occur during the product specific availability period as defined for each product in the RAA if the CSP also provides associated load data for each registration in order to calculate that registration’s capacity compliance.

10.4.6 Emergency and Pre-Emergency Energy Settlements Cost Allocation

See PJM Manual 28: Operating Agreement Accounting, Section 10.2 for cost allocation rules.

10.5 Aggregation for Economic, Pre-Emergency and Emergency Demand Resources

The purpose for aggregation is to allow the participation of end-use customers in the Energy Market that can provide less than 100 kW of DR when they currently have no alternative opportunity to participate on an individual basis or can provide less than 100 kW of DR in the Secondary Reserve (SecR), Synchronized Reserve (SR) or Regulation (REG) markets when they currently have no alternative opportunity to participate on an individual basis. An aggregation shall meet the following requirements:

- If the aggregation only provides energy to the market then only one end use customer within the aggregation shall have the ability to reduce more than 99 kW of load unless the CSP, LSE and PJM approve. If the aggregation provides SecR or SR to the market then only one end use customer within the aggregation shall have the ability to reduce more than 99kW of load unless the CSP, LSE and PJM approve. If the aggregation provides Regulation Only through and Economic Regulation Only Registration to the market then only one end use customer within the aggregation shall have the ability to reduce more than 99 kW of load unless the CSP and PJM approve.
- All end-use customers in an Economic Registration shall be served by the same EDC LSE and have the same energy pricing point. All end-use customers in an Emergency and Pre-Emergency Registration, Economic Registration of residential customers not participating in the Day-ahead Market, and Economic Regulation Only Registration shall be served by the same EDC and located in the same Transmission Zone. If the aggregation provides SR, all customers in the aggregation must also be part of the same Synchronized Reserve sub-zone.
- All end-use customers in an aggregation and on the same registration shall be located in the same Transmission Zone, existing load Aggregate, or at the same node except for an Economic Regulation Only Registration. All end-use customers in an aggregation and on the same Economic Regulation Only Registration shall be located in the same Transmission Zone.
- Each end-use customer site must meet the requirements for market participation by a Demand Resource except for the 100 kW minimum load reduction requirement for Energy and Ancillary Services.
- An end-use customer's participation in the Energy and Ancillary Service Markets shall be administered either under one Economic Registration or if only providing Regulation service then with an Economic Regulation Only Registration and an Economic (Energy Only Registration) as outlined in this Manual.

10.5.1 Calculations for the Weighted Average Line Loss Factor

When all end-use customers in a registration are not subject to the same Line Loss Factor, the factor for the registration shall be the registration load reduction weighted average of the factors for end-use customers in an aggregation.

PJM shall calculate the Ratio Share for each end-use customer as the percentage share of the summation of the individual anticipated load reduction capabilities (total kW).

PJM shall calculate the Weighted Average Line Loss Factor (WA LF) by multiplying the Ratio Share times the Loss Factor (LF) for each end-use customer and totalizing the results. The WA LF shall represent the LF of the registration.

PJM shall provide the calculation of all load weighted values and their supporting data to the LSE and CSP at the time of registration.

The following table illustrates an example of the calculation of the WA LF.

Customer	1	2	3	Total
kW	32.02	22.46	50.91	105.38
Ratio Share	30.38%	21.31%	48.31%	100.00%
G&T	\$0.0500	\$0.0660	\$0.0890	
LF	1.0680	1.0790	1.0900	
WA G&T	\$0.0152	\$0.0141	\$0.0430	\$0.0722
WA LF	0.32448	0.22995	0.52654	1.08097

10.5.2 Settlement for Aggregation

All end-use customers in the registration are considered to have individually participated in each curtailment event if cleared in the Day-ahead Market or was dispatched by PJM in Real-time Market. All supporting details as outlined below will be available to the LSE after the settlement is submitted by the CSP, except where the end-use customers in the registration are not required to have the same LSE.

- Registration CBL is based on the sum of each end use customer's meter data where each end use customer is defined as a unique EDC account number.
- Meter data for each end use customer in the aggregation, except for non-interval metered residential Direct Load Control Registrations, where a statistical sample of end use customers may be used for meter data, in accordance with PJM Manual 19: Load Forecasting and Analysis, Attachment D.
- Metered Load - Each individual end-use customer in the aggregation will have its own metered load and the summation of the individual metered loads will represent the registration metered load. Non-interval metered residential Direct Load Control Registrations may use a statistical sample of end-use customers' meter data to represent the registration metered load in accordance with PJM Manual 19: Load Forecasting and Analysis, Attachment D.

- Weighted Average Loss Factor (WA LF) - The load reduction WA LF shall be the value calculated for the registration.

10.6 Interval Meter Equipment and Load Data Requirements

A CSP, LSE, EDC or agent designated by the CSP may fulfill the interval metering equipment and load data responsibilities that are required by PJM of the CSP for Economic, Pre-Emergency and Emergency DR resources including Ancillary Services. Interval metering equipment and load data used for retail electricity service are deemed to meet PJM requirements for energy settlement and capacity compliance.

The following documentation shall be provided by the CSP to PJM when non-retail electric service metering equipment and load data will be utilized for settlements or compliance. The CSP shall verify that all documentation is accurate and maintain compliance to PJM metering equipment and load data requirements.

- The date the metering equipment was installed, tested and ready to record, store and communicate interval load data for DSR activity.
- The person that installed the metering equipment.
- The make and model of the meter.
- Metering equipment accuracy (meter, CT and PT).
- CT & PT type designation.
- CT ratio.
- All metering equipment shall, at a minimum, meet appropriate ANSI c12.1 and c57.13 standards to ensure the metering equipment is within the Tariff defined accuracy standards.
- Metering equipment used for Ancillary Services shall meet additional requirements as defined in the PJM Tariff and/or Manuals.
- If equipment does not meet these standards, then on an exception basis, a field test may be conducted to validate the accuracy as long as the electricity service is less than 600 volts. PJM will review the field test results and associated metering equipment configuration to determine whether or not the use of metering equipment will be permitted.
- Metering equipment may include a pulse data recorder used in conjunction with a meter.

The CSP or designated agent shall maintain the relationship between the load data, metering equipment, EDC account number and other Customer Identifiers as defined. Further, the CSP or designated agent shall submit to PJM the quality assurance protocol used to ensure metering equipment accuracy over time. All interval load data, except where also used for retail electric service, shall at a minimum comply with the NAESB VEE (Validate, Edit & Estimate) standards, where applicable, for retail electric service to ensure the quality of the information. If a pulse data recorder is utilized then time shall be managed on a daily basis or per communication whichever is least frequent. Time may be checked and reconciled through the network time

protocol. Load data, including both pre and post VEE data shall be maintained for thirty-six (36) months by the CSP or designated agent. The CSP and/or designated agent will comply with requests for metering equipment and load data audit as necessary that may include but not be limited to the following:

- Be available for on-site verification of metering equipment.
- Provide load data history for Pre and Post VEE load data.
- Provide work order, cut sheet or other documentation to validate the installation of the metering equipment.
- Load data reconciliation where there are two metering systems present.

A CSP or their designated agent that violate these standards is not allowed to manage the installation/maintenance of metering equipment and associated load data for PJM settlements or compliance.

Non-retail electric service load data used for settlements or compliance is not reconciled by PJM to the retail electric service load data unless, to troubleshoot an issue or as part of an audit.

If the CSP elects to utilize non-retail electric service load data for settlements then the CSP will provide ninety (90) consecutive days of load data on an annual basis near the effective date of the registration to PJM and PJM will make this load data available to the appropriate LSE. In addition, the CSP or PJM shall provide load data to the EDC, as appropriate, for the peak load contribution add back process.

10.7 Use of Sub-meter Load Data to Support Demand Response Regulation Compliance

“Sub-meter” shall mean a metering point for electricity consumption that does not include all electricity consumption for the end-use customer as defined by the EDC account number. PJM shall only accept sub-meter load data from end-use customers for measurement and verification of Regulation service as set forth in the Economic Load Response rules and PJM Manuals.

“Location” as used in the Economic Load Response rules shall mean an end-use customer site as defined by the relevant EDC account number.

CSPs that have end-use customers that participate in the Regulation market may be permitted to use Sub-metered load data instead of load data at the EDC account number level for Regulation measurement and verification as set forth in the PJM Manuals and subject to the following:

- CSPs, must clearly identify for PJM all electrical devices that provide Regulation and identify all other devices used for similar processes within the same Location that do not provide Regulation. The Location must contribute to management of frequency control on the PJM electric grid or PJM shall deny use of Sub-metered load data for the Location.

- The CSP shall submit single line diagrams to PJM unless otherwise approved by PJM with Sub-metered device(s) clearly specified at the Location. PJM verifies that all similar devices at the Location are Sub-metered and if the similar devices are not Sub-metered, PJM will deny the use of Sub-meter load data unless the CSP can demonstrate that the electricity usage of such similar devices that are not Sub-metered do not offset the change in electricity usage of the electrical device that provides the Regulation service.
- If the registration to participate in the Regulation Market contains an aggregation of Locations, the relevant CSP will provide PJM with load data for each Location's Sub-meter through an after-the-fact load data submission process upon request by PJM.
- All telemetry load data to PJM is to be based on device electricity consumption for each registration. The registration load data must include load data from all Locations and from all devices approved at each Location on the registration. For example, if the registration has 3 Locations and each Location has one (1) pump that regulates then the telemetry load data will include the aggregate load data for all three (3) pumps.
- If the registration is an aggregation of Locations, the CSP will provide PJM with load data for each Location's Sub-meter through an after the fact load data submission process as determined by PJM. This allows PJM to confirm that the aggregate load data sent through telemetry consists of all Locations on such registration.

PJM may conduct random, unannounced audits of all Locations that are registered to participate in the Regulation market to ensure that devices that are registered by the CSPs as providing Regulation service are not otherwise being offset by a change in usage of other devices within the same Location.

Auditing includes a method of sampling Location level load data without CSP's prior knowledge of sites sampled. CSP will provide Location level load data (which represents load data for the EDC account number) to PJM upon request through after the fact meter data submission process as determined by PJM.

All CSP meter equipment will conform to meter data standards set forth in the PJM Tariff and the PJM Operating Agreement and as defined in Section 10 of this Manual and all CSP telemetry will comply with the standards set forth in the PJM Tariff, PJM Operating Agreement and PJM Manual 12: Balancing Operations, Section 4.

PJM may suspend the Regulation market activity of Economic Load Response Participants, including CSPs, that do not comply with the Economic Load Response and Regulation Market requirements as set forth in Schedule 1 of the Tariff and the PJM Manuals, and may refer the matter to the Independent Market Monitor and/or the Federal Energy Regulatory Commission Office of Enforcement.

Section 11: Section Retired

11.1 Section Retired

11.2 Section Retired

Section 12: Overview of the Price Responsive Demand

Welcome to the Overview of the Price Responsive Demand section of the PJM Manual for Energy & Ancillary Services Market Operations. In this section you will find the following information:

- An overview description of the Price Responsive Demand (see “Overview of PJM Price Responsive Demand”).
- A list of the Price Responsive Demand Business Rules (see “PJM Price Responsive Demand Business Rules”).

12.1 Overview of Price Responsive Demand

The development and implementation of dynamic and time-differentiated retail rates, together with utility investment in Advanced Metering Infrastructure (AMI) led to an increasing quantity of load in PJM to be responsive to changing wholesale prices. Through enabling technology and behavioral changes, consumers modify their demand as prices change without being centrally dispatched by PJM or bidding demand reductions into the PJM markets. Given the linkage between dynamic retail rate structures and wholesale prices, this price responsiveness is predictable and needs to be accounted for in the wholesale market design and operations.

This predictable reduction in consumption in response to changing wholesale prices is known as Price Responsive Demand (PRD). The continued development of PRD requires coordination between the wholesale market and the retail rate design to maximize its benefit to consumers. The deployment of AMI for small commercial and residential customers enables dynamic and time-differentiated retail rate structures linked to wholesale prices. AMI supports dynamic retail rate structures and these types of retail rates provide the exposure to market prices necessary to provide the incentive for retail customers to reduce or shift consumption in response to price.

Although PRD is not directly dispatchable by PJM, automated retail customer response to Real-time Energy price signals can produce a predictable demand curve as a function of price. Prices typically increase during capacity emergencies and as a consequence demand drops. PRD will therefore be able to reduce the installed capacity required to meet Loss of Load Expectation (LOLE) based reliability standards.

PRD is provided by a PJM Member that represents retail customers that have the capability to reduce load in response to price. The PJM Member acting on behalf of such retail customers for the purpose of providing PRD is referred to as the PRD Provider. A PRD Provider for a given retail customer must meet all of the eligibility requirements for providing PRD.

12.2 Price Responsive Demand Business Rules

12.2.1 Price-Demand Curves in the Energy Market

PRD committed in RPM for the current Delivery Year bids in the PJM Energy Market per the business rules below. For details about PRD participation in the PJM Capacity Market, refer to PJM Manual 18: PJM Capacity Market.

PRD that is not committed in RPM for the current Delivery Year has the option to bid in the Energy Market as an “Energy Only” bid. If PRD is bid into the market as “Energy Only”, the Maximum Emergency segments that are not committed MW of capacity may submit a bid price up to the Energy Market offer cap.

End-use customer loads identified as PRD may not, (i) be registered as Economic Load Response or Emergency Load Response; (ii) be used as the basis of any Demand Resource Sell Offer or Energy Efficiency Resource Sell Offer in any RPM Auction; or (iii) be identified in a PRD Plan or PRD registration of any other PRD Provider.

12.2.2 Characteristics of Price-Demand Curves in the PJM Energy Market

The Price-Demand Curves (PRD Curves) for PRD committed in RPM for a Delivery Year will have the following characteristics and can be submitted in the PJM Energy Market on a daily basis:

- PRD Curves accepted at the time of PRD registration, are used as default PRD bids in the Day-ahead Market clearing process. Updates to the default curves may be submitted into the Day-ahead Market on a daily basis by 11:00 at the closing of the Day-ahead bid period.
- PRD Curves in the Energy Market are modeled in the Real-time dispatch algorithms and can set Real-time LMP. PRD will set Real-time LMP based on offer price on the PRD curve, as described in Section 12.2.3 of this Manual. If a PRD Curve is marked as “unavailable”, the PRD Curve is ineligible to set Real-time LMP. PRD Curves in the Energy Market must be submitted locationally; identified at the substation location within a transmission zone as electrically close as practical to the applicable load (i.e., PNODE). PJM will provide assistance to EDCs to post mapping files that map PNODES to geographic locations such as zip codes.
- PRD curves include the following parameters:
 - Availability flag
 - Response rate
 - Minimum quantity of PRD
 - Maximum quantity of PRD
- PRD Curves in the Energy Market must be non-increasing and can have up to 10 price-quantity segments for each hour.

- PRD Providers with committed PRD are required to have automation of PRD that is needed to respond to Real-time LMPs for the PRD Curves that are submitted.
- The maximum bid price of the PRD Curve is the applicable energy market offer cap.

12.2.3 Section Retired

12.2.4 Price-Demand Curves in Real-time Energy Market Operations

During normal Economic conditions:

- PRD Curves are included in Security Constrained Energy Dispatch (SCED).
- PRD can set Real-time LMPs up to the Energy Market offer cap.

During Emergency conditions:

- PRD must be curtailed once PJM has;
 - Declared a Performance Assessment Interval; and
 - The Real-time LMP at the applicable location meets or exceeds the price on the submitted PRD curve at which the load has committed to curtail.
- Effective with the 2022/2023 Delivery Year and thereafter, PJM will issue an Emergency procedures notification to indicate when there is a Performance Assessment Interval so PRD providers know when they are required to reduce load.
- During Emergency conditions, PJM will use Real-time data submitted by PRD Providers to determine the availability and actual response of PRD, per the rules for Load Management Operational Reporting.

12.2.5 Section Deleted

No longer relevant.

12.2.6 PRD Curves Submitted by PRD Providers

PRD Curves may be submitted by PRD Providers in the PJM Energy Market by 11:00 at the closing of the Day-ahead bid period.

PRD Curves submitted by PRD Providers are identified in the Day-ahead Market software and user interface.

PRD bids are modeled in the Real-time Energy Market only, and are modeled in the Real-time dispatch algorithms. PRD curves are not modeled in the Day-ahead Market clearing process.

PRD curves do not result in any Energy Market charges to the PRD Provider.

Attachment A: Interchange Energy Schedule Curtailment Order

Interchange Energy Schedule Curtailment Orders are detailed in Section 2.6 of PJM's Regional Transmission and Energy Scheduling Practices.

Attachment B: Pumped Storage Modeling

This Attachment describes the pumped storage model developed by PJM that can be used by participants to schedule their pumped storage plants optimally.

Description of Model

The model treats the pumped storage plant as a megawatt-hour (MWh) reservoir. When the plant generates, MW are removed from the reservoir. When the plant pumps, MW are added. A pumping efficiency factor is used to translate the pump load to energy transferred into the reservoir. The following figure illustrates the model for a single time period.

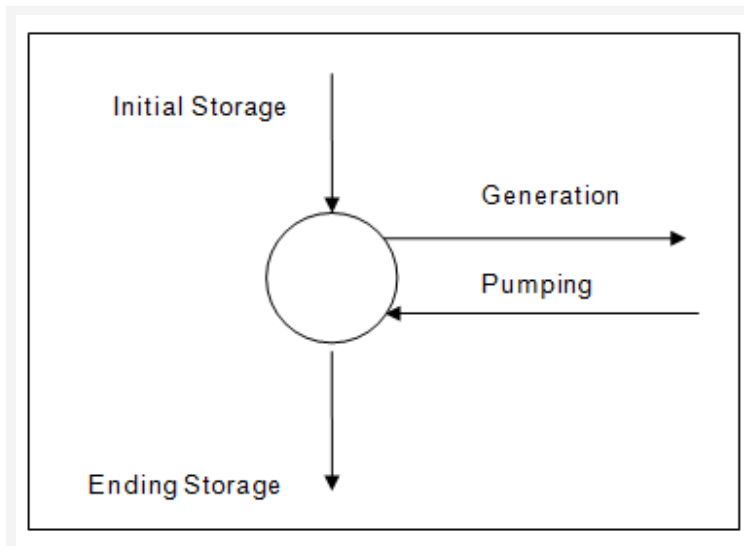

This model enforces the classical “Conservation of Flow” constraint for each hour. Hourly Plant Storage may also be constrained by MaxStorage and MinStorage values. The Beginning and Ending Storage for the day can then be constrained by setting the MaxStorage and MinStorage values.

Since the objective of the unit commitment software is to minimize total cost over the study period, the resulting generation and pumping schedule will be maximized so as to produce the lowest possible system cost (maximum benefit). The conservation of flow constraint assures us that pumping will only occur if the cost of pumping can be offset by an associated benefit of generating.

The inputs to the model include:

- **Plant Data:**

- Initial Storage Level,
- Final Storage Level,
- Maximum Storage Level,
- Minimum Storage Level, and
- Pumping efficiency factor.
- **Unit Data:**
 - Minimum and Maximum generating and pumping limits

Note:

Note that pumping increases the storage by: $\text{Pumping Efficiency} * \text{Pumping MWh}$ and generation decreases the storage by the MWh the plant is generating.

Attachment C: Deleted

Attachment D: Verification of Offers greater than \$1,000/MWh that were not eligible to set LMP

This Attachment addresses the procedures by which Market Sellers that incur incremental operating costs for a generation resource greater than \$1,000/MWh can receive credit for Operating Reserves. The aim of the procedure is to:

- Enable generation resources with cost-based offers greater than \$1,000/MWh, and less than \$2,000/MWh, which did not pass the offer screening process, as described in Section 2.3.6.2 of this Manual, in time to set LMP for all or a portion of the operating day, and which are scheduled or requested to operate by PJM System Operations to be paid Operating Reserve credits under certain conditions:
 - A generation resource may be eligible for Day-ahead Operating Reserve credit if it was scheduled by PJM and the submitted offer is accepted into Markets Gateway and verified after the Day-ahead Market closes.
 - A generation resource may be eligible for Balancing Operating Reserve (BOR) credit if that resource is dispatched and the resource's submitted offer is accepted into Markets Gateway and verified following the operating interval.
- Enable generation resources with validated cost-based offers greater than \$2,000/MWh that are scheduled or requested to operate by PJM System Operations to be made whole under certain conditions:
 - A generation resource may be eligible for Day-ahead Operating Reserve credit if it was scheduled by PJM and the submitted offer is accepted into Markets Gateway and verified.
 - A generation resource may be eligible for BOR credit if that resource is dispatched and the resource's submitted offer is accepted into Markets Gateway and verified.
- Enable generation resources with price-based offers greater than \$1,000/MWh and less than or equal to their cost-based offer to be made whole if the reference cost-based offer did not pass the offer screening process, as described in Section 2.3.6.2 of this Manual, in time to allow the price-based offer to be greater than \$1,000/MWh for all or a portion of the operating day to be paid Operating Reserve credits under certain conditions:
 - A generation resource may be eligible for Day-ahead Operating Reserve credit if it was scheduled by PJM and the submitted offer's reference cost-based offer is accepted into Markets Gateway and verified after the Day-ahead Market closes.
 - A generation resource may be eligible for BOR credit if that resource is dispatched by PJM and the submitted offer's reference cost-based offer is accepted into Markets Gateway and verified following the operating interval.
- Explain the process Market Sellers can request to be paid Operating Reserve credits based on the resource's cost-based offer, which did not pass the offer screening process, as described in Section 2.3.6.2 of this Manual. Market Sellers can submit relevant

documentation to PJM and the MMU to verify the cost-based offer via the Markets Gateway "Fuel Price Exceptions" tab. The cost-based offer must be consistent with the PJM approved Fuel Cost Policy. This procedure does not guarantee cost recovery. PJM must review and approve the Market Seller's costs before any Operating Reserve credits are paid to a Market Seller under this Attachment D.

Eligibility

A generation resource with a cost-based offer greater than \$1,000/MWh developed in accordance with PJM Manual 15: Cost Development Guidelines and the Market Seller's PJM-approved Fuel Cost Policy is eligible when:

- A generation resource's cost-based offer did not pass the offer screen or a generation resource has a cost-based offer greater than \$2,000/MWh.
- PJM and the MMU have received the Market Seller's submitted documentation that supports the payment of Operating Reserve credits.
- PJM, with timely input and advice from the MMU, has verified all costs, including start-up, no-load, and incremental energy, used to calculate the Operating Reserve credits using the exception process described in Section 2.3.6.2 of this Manual, and PJM has approved the credits.

Settlements

Generation owners of resources committed by PJM that meet the eligibility criteria to be compensated using this procedure have until 11:00 EPT on the business day following the operating day to submit an e-mail to EnergyOfferVerification@pjm.com and MMU_Energy_Offers_Review@monitoringanalytics.com with the following information:

- Unit Name,
- Date of operation,
- Applicable time of operation,
- Contact information (name of sender, phone, e-mail),
- Date and time of PJM Dispatch contact to generator, and
- Documentation of the Market Seller's calculation of the cost-based offer in accordance with PJM Manual 15: Cost Development Guidelines and applicable Fuel Cost Policy.

Revision History

Revision 130 (03/20/2024):

- [Addition of Interface Prices section \(2.20\)](#)

Revision 129 (02/22/2024):

- Retirement of Real Time Values section (2.3.4.4) and additions to Parameter Limited Schedule Exceptions section (2.3.4.3)

Revision 128 (12/14/2023):

- Zonal Factors Updates (2.3.2.4)

Revision 127 (11/15/2023):

- Offer Verification Updates (2.3.6.2, Attachment D, Attachment C Retired)
- Hybrids Phase 2 Conforming Language (2.3.3, 2.3.4C.1)
- PAI Triggers Conforming Language (New Section 2.19)
- Renewable Dispatch Conforming Language (2.3.3.1)
- Regulation Reference Update (3.2.8)
- Reserves Reference Update (4.3)
- NSRMCP Formula Clarification (4.4.1)

Revision 126 (05/31/2023):

- Real Time Values Updates (2.3.4.4)
- Transmission Constraint Penalty Factor Conforming Language (2.17)
- Hybrids Phase 1 Conforming Language (2.1.1, 2.3.3, 2.3.4C, 2.3.4C.1, 4.2.1, 4.2.2, 4.2.3, 9.1)

Revision 125 (05/18/2023):

- Section 4.3 – Added clarification for establishing Reliability Reserve Requirement

Revision 124 (04/26/2023):

Cover to Cover Periodic Review

Changes made throughout:

- Grammar, Punctuation, Typo, Syntax Consistency, Reference Updates
- Updated Outdated Hyperlinks
- Addition of clarifying words and phrases

- Deletion of duplicate material
- Paragraph Spacing
- Change all references of “Office of the Interconnection” to “PJM”
- Remove outdated references to DASR
- Add references to SecR

Section 2

- Added descriptor for Stability Limits at top of section.
- Section 2.1.2 Reword of Fast-Start Capable Adjustment Process section
- Section 2.3.3.1: Clarification that run times consider notification or startup times
- Section 2.3.3.1: Additional detail about the maximum number of MW/Price segments allowed
- Section 2.3.4.2: Updated method to communicate Unit Specific Parameter Adjustments
- Section 2.3.6.2: Updated method to submit exception requests from the previously used template to Markets Gateway form and PJM Connect website.
- Section 2.3.8: Clarification that Up-To Congestion Transactions are modeled in the RSC
- Section 2.5.2: Clarification that IT SCED has two hour look ahead period
- Section 2.14: Removed opening paragraph that is redundant from M28

Section 4

- Section 4.7: Clarify submission time of Bilateral Reserve Transactions from 14:15 to 13:30

Section 5

- Section 5.2: Remove outdated reference to “Transmission Outage Data System”
- Section 5.2.3: Rewrite of Load Forecasting Procedure to replace outdated information and detail updated processes
- Section 5.2.6: Addition of paragraphs to detail the objective of the SPD and RSC software packages
- Section 5.2.7.3: Additional language to clarify Composite Energy Offer adjustments and their relation to the OA

Section 7

- Section 7.3.2: Additional detail about how RT SCED treats CTS transactions.

Section 9

- Section 9.1: Additional detail about Hourly State of Charge of an ESR

Section 10

- Section 10.3: Updated language to “and/or” as defined by PJM for how location of a DSR is determined.
- Section 10.4.2: Removal of Weather Sensitivity Adjustment from bulleted list detailing CBL notes.

Section 12

- Section 12.2.4: Deleted references to detail about Price-Demand curves in prior delivery years

Attachments C and D

- Updated email alias used to submit supporting documentation

Revision 123 (02/09/2023):

- Updated section 10.2.2 to prohibit Critical Natural Gas Infrastructure locations in the registration.

Administrative Change (Approved by Brian Chmielewski and Joe Ciabattoni 01/06/2023):

- Section 10.2.2.2: Updated binary pronoun usage (e.g., “he or she” to a gender-neutral equivalent (e.g., “they,” etc.) in order to support PJM’s diversity, equity and inclusion efforts.

Revision 122 (10/01/2022):

- Conforming changes to account for Reserve Price Formation implementation to take effect 10/1/2022 (FERC Dockets: EL19-58-000 and ER19-1486-000).
 - Merged existing Reserve Sections listed below into one complete Section 4: PJM Reserve Markets
 - 4: Overview of the PJM Synchronized Reserve Market
 - 4b: Overview of the PJM Non-Synchronized Reserve Market
 - 11: Overview of the Day-ahead Scheduling Reserve Market
 - Added new subsections in Section 4: PJM Reserve Market to describe Day-ahead and Real-time Reserve Market structure
 - 4.1 Overview of the PJM Reserve Markets
 - 4.2 PJM Reserve Markets Offer Business Rules
 - 4.3 Reserve Requirement Determination
 - 4.4 Reserve Market Clearing
 - 4.5 Event Performance
 - 4.6 Reserve Obligations
 - 4.7 Bilateral Transactions
 - 4.8 Settlements

- Edited the following sections:
 - 1 – Overview
 - 1.1 – PJM Responsibilities
 - 2.3.3.2 – Generation Schedules
 - 2.3.7 - Mechanical/Technical Rules
 - 2.7 – Locational Pricing Calculator (LPC)
 - 2.8 – The Calculation of Locational Marginal Prices (LMPs) During Emergency Procedures
 - 2.9 – Shortage Pricing
 - 2.14 – Balancing Operating Reserve Cost Analysis
 - 3.1 – Overview of the PJM Regulation Market
 - 3.2 – PJM Regulation Market Business Rules
 - 5.2.4 – Markets Database System
 - 10.1 – Overview of Demand Resource Participation
 - 10.2 – Demand Resource Registration Requirements
 - 10.4.1 – Metered Data
 - 10.5 – Aggregation for Economic, Pre-Emergency and Emergency Demand Resources
- In addition to the conforming changes for Reserve Price Formation, the following changes are also included:
 - Section 2.5.3.3 - Real-time Security Constrained Economic Dispatch Methodology
 - Updated Achievable Target MW calculation
 - Updated definition of up/down ramp rate used o Updated diagram to reflect these changes
 - Updated DA Market Ops Manual owner from Mike Ward to Joe Ciabattoni

Revision 121 (7/7/2022):

- Updated Section 2.7.2 to reflect new logic for determining LMPs for De-Energized Busses

Revision 120 (5/25/2022):

- Added Section 2.18 to describe the modeling, clearing and reporting rules regarding stability limits
- Added Section 2.18.1 to include station stability limit units which are also not eligible for LOC credits for the MW reduction due to stability limits

Revision 119 (3/23/2022):

- Updated Section 2.3.3.2 to add language to support Pseudo Modeled Combined Cycle Units
- Added Section 2.3.4.6 to address minimum run time for Pseudo Modeled Combined Cycle Units
- Updated the approver from Phil D'Antonio to Brian Chmielewski due to a management change
- Section 2.3.4.3 updated for grammar, punctuation and additional minor clean-up

Revision 118 (03/01/2022):

- Updated Section 4b.1 to remove inaccurate language
- Updated Section 10.4.1 to indicate correct reference attachment
- Updated Section 9.1.1 to clarify that the generation resource's fuel cost policy only needs to be updated when opting in to intraday for the cost-based schedule.

Revision 117 (11/01/2021):

- New Sections
 - Section 2.5.1 Ancillary Service Optimizer (ASO)
 - Section 2.5.2 Intermediate Term Security Constrained Economic Dispatch (IT SCED)
 - Section 2.5.3 Real-time Security Constrained Economic Dispatch
 - Section 2.5.3.1 Real-time Security Constrained Economic Dispatch Optimization
 - Section 2.5.3.2 Real-time Security Constrained Economic Dispatch Marginal Resource Identification
 - Section 2.5.3.3 Real-time Security Constrained Economic Dispatch Methodology
 - Section 2.5.3.4 Real-time Security Constrained Economic Dispatch Timeline and Instruction Set
 - Section 2.5.3.5 Real-time Security Constrained Economic Dispatch Inputs
 - Section 3.2.8.1 Hydropower Operation
- Updated to provide clarity on how Five (5) Minute Dispatch & Pricing will impact the current business rules
 - Section 2.3.3.1
 - Section 2.5
 - Section 2.6
 - Section 2.7
 - Section 3.2.2
 - Section 3.2.7.4
 - Section 3.2.7.5
 - Section 3.2.7.6

- Section 3.2.7.7
- Section 3.2.8
- Section 4.2.4
- Section 4b.2.3
- Terminology Changes
 - Market Applications updated to Market Clearing Engines
 - Hydro updated to Hydropower

Revision 116 (09/01/2021):

- New Sections
 - Section 2.1 Overview of PJM Energy Markets
 - Section 2.1.1 Fast-Start Capable Resources
 - Section 2.1.2 Fast-Start Capable Adjustment Process
 - Section 2.1.3 Eligible Fast-Start Resources
 - Section 2.1.4 Day-ahead Energy Market
 - Contains existing language with minor modifications
 - Section 2.1.5 Real-time Energy Market
 - Contains existing language with minor modifications
 - Section 2.3.6.3 Generation Resource Composite Energy Offer Screening Process for Composite Offers more than \$1,000/MWh
 - Section 2.7.1 Energy Offers used in Real-time Price Calculation
 - Section 2.7.3 Determination of LMPs for Generation Resources with Composite Energy Offers greater than 1,000/ MWh and equal to or below \$2,000/MWh
 - Section 2.7.5 Determination of LMPs for Composite Energy Offers Greater than \$2,000/MWh
 - Section 5.2.7.1 Day-ahead Integer Relaxation
 - Section 5.2.7.2 Energy Offers used in Day-ahead Price Calculation
 - Section 5.2.7.3 Determination of LMPs for Generation Resources with Composite Energy Offers Greater Than \$1,000/MWh and equal to or below \$2,000/MWh
 - Section 5.2.7.4 Determination of LMPs for Generation Resources with Offers Greater than \$2,000/MWh
 - Section 5.2.7.5 Determination of LMPs for Composite Energy Offers Greater than \$2,000/MWh
 - Section 10.3.1 Economic Load Response Resource Composite Energy Offer Screening Process for Composite Offers more than \$1,000/MWh

- Section 10.3.2 Determination of LMPs for Economic Load Response Resources with Composite Energy Offers greater than 1,000/ MWh and equal to or below \$2,000/ MWh
- Section 10.3.3 Determination of LMPs for Composite Energy Offers Greater than \$2,000/MWh
- Updated to provide clarity on how Fast-Start Pricing will impact the current business rule(s)
 - Section 2.2
 - Section 2.3.2.3
 - Section 2.3.6.1
 - Section 2.5
 - Section 2.7
 - Section 2.8
 - Section 2.9
 - Section 2.9.1
 - Section 2.17
 - Section 3.1
 - Section 3.2.7.4
 - Section 3.2.7.5
 - Section 4.1
 - Section 4.2.6
 - Section 4b.1
 - Section 4b.2.4
 - Section 7.2
 - Section 7.3.4
 - Section 11.2.3
 - Section 11.2.5
 - Attachment D
- Retired
 - Section 2.13
- Renumbered
 - Section 2.7.2
 - Previously 2.7.1
 - Section 2.7.4
 - Previously 2.7.2
 - Section 5.2.6.1

- Renamed to Section 5.2.7
- Section 10.3.4
 - Previously 10.3.1
- Title and language updated to use proper terminology
 - Section 2.4

Revision 115 (06/01/2021):

PRD Changes due to Docket ER21-1243

- Removed specific wording for LSE, EDC and CSP from PRD Provider description (Section 12.1)
- Removed section for the calculation of LSE's BOR deviations from PRD (Section 12.2.5)
- Removed reference to direct load responsibility (Section 12.2.6)

Revision 114 (05/26/2021):

- New Section 2.3.3.5 for business rules for Public Distribution Microgrid Generators.

Revision 113 (03/29/2021):

- Cover to cover periodic review.
 - Updated grammar, spelling, terminology and hyperlinks throughout.
 - Sections 2.3.3A.2, 2.3.3A.3, 2.3.4, 2.3.4.1, 2.3.4.2, 2.3.4.4, 2.3.4.5: Removed all language related to Base Capacity Resources
 - Section 2.3.4B: Removed language related to the first day of the ESR Participation Model
 - Section 2.12: Update all UDS terms to Dispatch Signal
 - Section 5.2.3.1: Removed
 - Section 3.2.10: Removed most of section, information contained in other parts of the Manual

Revision 112 (01/05/2021):

Revision includes:

- Updates to Section 9.1 and 9.1.1 for changes from the Modeling Generation Senior Task Force related to Hourly Differential Segmented Ramp Rates

Revision 111 (11/19/2020):

- Updates for increased transparency stemming from work at Five Minute Dispatch and Pricing MIC Special Session
- Changed LMP Verification to Price Verification to incorporate verification of Market Clearing Prices (MCPs) in addition to LMPs.

- Updates to Sections 2.2, 2.10, 2.11, 5.2.6

Revision 110 (10/28/2020):

- Section 12.2.4: Update PRD business rules for performance assessment trigger based on FERC Order ER20-271-00

Revision 109 (10/15/2020):

Revision includes:

- Updates for Five Minute Dispatch and Pricing Short Term implementation that aligns dispatch and pricing intervals
- Updates for increased transparency stemming from work at Five Minute Dispatch and Pricing MIC Special Session
- Updates to Sections 2.1, 2.2, 2.4, 2.5, 2.6, 2.7, 2.9.1, 3.1, 4.1, 4b.1

Revision 108 (12/03/2019):

- Updates for FERC Order 814 Electric Storage Resource Participation Model
- Added Section 2.3.4B Energy Storage Resource (ESR) Participation Model and updated Sections 2.3, 3.2, 4.2, 4b.2, 9.1, 11.2 where appropriate

Revision 107 (09/26/2019):

- Document ownership updated from Lisa Morelli to Philip D'Antonio
- Section 3.2.9: Inclusion of process for addressing regulation historic performance scores for an operating day that fail to bridge over into the market clearing system
- Section 4.2.2: Clarifying language on reserve requirement determination for market clearing purposes

Revision 106 (05/30/2019):

Language to address a credible gas contingency(s) in the calculation for increasing the Day-Ahead Scheduling Reserve Requirement:

- Section 11.2.1 Day-Ahead Scheduling Reserve Market Reserve Requirement

Language added to clarify the reserve market eligibility of resources impacted by a credible gas pipeline contingency(s):

- Section 4.2.1 Synchronized Reserve Market Eligibility
- Section 4b.2.1 Non-Synchronized Reserve Resource Eligibility
- Section 11.2.2 Day-Ahead Scheduling Reserve Market Eligibility

Revision 105 (04/25/2019):

- Cover to cover periodic review.

- Updated grammar throughout
- Updated “About this Manual” section to account for Additional Manual References
- Reorganized Sections 2.3.2, 2.3.3, 2.3.4, 2.3.6 and 10.2.2 for readability
- Removed irrelevant data in:
 - Section 1 (Figure 1)
 - Section 1.2.2: Reference to Member Administrative Committee
- Clarified commitment requirements for Capacity Resource Energy Market Offer rules to align with Tariff (Sections 1, 2.3)
- Section 2.3.4: Removed CP Transition Year language
- Section 2.3.4A: Relocated UTC business rules to Section 2.3.2 Market Buyers
- Section 2.3.10: Clarified process for addressing data input/system failures when calculating LMPs under 5-minute Settlements
- Section 2.14: Clarified cap to resource offers includes the lesser of a 10% adder or \$100. Added missing Delmarva and OVEC zones to Region lists.
- Section 3.2.7: Clarified use of LOC in Regulation clearing and pricing
- Section 6: Removed most of section, relocated language to existing sections as appropriate.
- Section 11.2.1: Incorporated previously approved language that was lost due to versioning issue
- Attachment A: Removed detailed language and provided a reference to OASIS Business Practices Section 2.6
- Updates to Location Fields in DR hub
 - Updates to Section 10.2.2 to add new fields for Location Generators and Batteries and minor formatting for clarity

Revision 104 (02/07/2019):

- Updated NSR Eligibility Requirements to require real-time telemetry.

Revision 103 (2/01/2019):

- Added Section 2.17 to describe the use of transmission constraint penalty factors in the Day-ahead and Real-time Market Clearing Engines per FERC Order (Docket: ER19-323-000)

Revision 102 (1/22/2019):

- Conforming change in Section 3.2.7 to specify only resources with a benefits factor of 0.1 or greater may clear in the Regulation Market per FERC Order (Docket: ER19-383-000)

Revision 101 (01/09/2019):

- Updates to Sections 2.7, 2.8, 2.9.1 to clarify the use of approved RT SCED solution in determination of Shortage Pricing in Locational Pricing Calculator (LPC).

Revision 100 (12/20/2018):

- Distributed Energy Resources (DERS)
 - Section 10.2 – clarified requirements for On-Site Generator used as demand response resource to reduce load and to inject power with appropriate interconnection agreement.

Revision 99 (12/06/2018):

- Conforming changes throughout to reflect Day-Ahead Market Closing change from 1030 to 1100.

Revision 98 (10/25/2018):

- Section 2.3.3: define business rules to allow Price-based offers to exceed \$1,000/MWh • Section 2.3.4A: define business rules for Day-ahead Pseudo-Tie Transactions

Revision 97: (07/26/2018):

- Updates to Section 2.3.3 and Attachment D to align price-based offer cap with Tariff/OA language.

Revision 96 (07/01/2018):

- Updates to Section 4.2.1 to add language to address the synchronized reserve maximum in order to increase the accuracy of Tier 1 estimation

Revision 95: (06/01/2018):

- Conforming change in Section 2.3.2 and Section 2.3.3 regarding Virtual Bidding Locations as per FERC order (Docket Nos. ER18-88-000, ER18-88-001).
- Updates to sections 2.3.7, 9.1, 9.1.1, 10.3 to increase flexibility for resource offer submission to PJM systems.
- Renamed Section 9.1 – Hourly Scheduling Adjustments to Section 9.2 – Self-Schedule Adjustments

Revision 94 (04/12/2018):

- Updates to sections 2.3.2, 2.3.3, 2.3.6.2, and Attachment D associated with FERC Order No. 831 to implement Offer Verification for Offers > \$1,000 effective April 12, 2018.

Revision 93 (04/01/2018):

- Conforming revisions throughout to reflect change in Real-time Settlement Interval (5 minute settlements)

Revision 92 (11/01/2017):

- Revisions throughout to implement hourly differentiated offers and the ability to update offers intraday

Revision 91 (10/03/2017):

- Revised Section 7 to include PJM-MISO Coordinated Transaction Scheduling
 - Added Sections 7.2 and 7.3 to support the Coordinated Transaction Scheduling implementation

Revision 90 (07/27/2017):

- Section 2.3.7 – describe the items needed in each energy offer that is needed to qualify for exempt or bonus MW during a Performance Assessment Hour

Revision 89 (07/12/2017):

- Section 2.3.2 and 2.3.3 – added clarity to which step in the demand curve is used
- Section 2.5 – removed wording describing the demand curve and penalty factors and reworded within, Section 4.2
- Section 2.9 and 2.9.1 – capitalization and removal of requirement to report false positives to FERC
- Section 4.2.2, 4.2.2.1, 4.2.9 and Section 4b.2.2 – incorporated language from Section 2.5 and clarified how the demand curves, penalties factors and requirements are structured
- Section 4.2.2.1 is a new section defining the shape of the demand curve and adding the additional permanent 190 MWs associated with Step 2

Revision 88 (5/11/2017):

- Sections 2.5; 2.9 and 2.9.1 Edits associated with FERC Order No. 825 to implement the transient shortage rule changes effective May 11, 2017

Revision 87 (3/23/2017):

- Section 4.2.2; 4b.1 and 6.2 – Providing one location on where to find the Primary Reserve and Synchronized Requirements (Manual 13, Section 2.2)
- Section 4.2.2 – provided updated explanation of what resources and the associated MWs are used for “double spin?; removed on peak / off peak requirement differentiation during “double spin?”
- Section 4b.2.3 – added clarity that the NSRMW should not go negative

Revision 86 (02/01/2017):

- Revision to sections 3.2.4 and 6.1.1: updated the regulation requirement period and the regulation requirement effective MW to defer to Manual 12 Section 4.4.3 – Determining Regulation Assignment.
- Removed references to Manual 35 as this manual was retired on November 17, 2016.

Revision 85 (11/01/2016):

- Revisions to 10.4.5 Emergency and Pre-Emergency Settlements to use Economic CBL for energy settlements instead of “hour before? CBL method. Corresponding tariff provisions approved by FERC under ER16-2460.

Revision 84 (08/25/2016):

- Cover to Cover Periodic Review

Revision 83 (07/28/2016):

- Revisions to section 11.2.2 regarding the default non-eligibility in Day-Ahead Scheduling Reserve process for certain unit types.

Revision 82 (07/01/2016):

- Revisions to section 11.2.2 regarding Day-Ahead Scheduling Reserve eligibility for Dynamic Transfer resources.

Revision 81 (06/01/2016):

- Revisions to section 2.3.4 for ‘Real Time Values’.

Revision 80 (03/31/2016):

- Revisions to various sections regarding effective operating day of 04/01/2016 for Day-Ahead Market timeline changes related to dockets No. ER14-24-000 & ER15-2260-001
- Changed all timings to 24 hour format
- References to eMKT application were updated to Markets Gateway
- Revisions to sections 2.3.3 and 2.3.4 for Parameter Limited Schedule changes related to the implementation of Capacity Performance effective from 06/01/2016 (dockets No.ER15-623 and EL15-29).
- New section 2.3.10 for operating parameter definitions
- Revisions to section 6.3.5 for cancellation fee of pool-scheduled resources

Revision 79 (12/17/2015):

- Revisions to section 2.3.2 Market Buyers, 2.3.3 Market Sellers, 2.3.9 Day-ahead Locational Marginal Price (LMP) Calculations, 2.7.2 Determination of LMPs for Generation Resources with offers greater than \$2,000/MWh, 2.9 The calculation of Locational Marginal Prices (LMPs) During Reserve Shortages, 2.14 Balancing Operating Reserve Cost Analysis, 2.15 Maximum Emergency Energy in the Day-Ahead Market, and Attachment D: Verification of Cost Offers greater than \$2,000/MWh effective 12/14/2015 offer cap language conforming change related to Docket No. ER16-76-000.

Revision 78 (12/14/2015):

- 3.1 – Revisions for clarity and to clean up formatting

- 3.2.4 – Minor revision for clarity
- 3.2.7 – Revised the Benefits Factor Curve to a more steeper slope intersecting x-axis at 40 (from 62)
- 3.2.7 – Updated business rules to recognize hours of the day with need for more sustaining regulation (RegA) and where RegD with benefits factor less than 1 will not be considered in the regulation clearing because of its reduced benefits
- 3.2.7 – Added frequency of benefits factor calculation
- 3.2.7 – Added benefits factor calculation steps
- 3.2.9 – Removed a bullet about operating bandwidth around the RTO regulation requirement. A new requirement had been defined during the Performance Based Regulation implementation in section 4.4.3 of Manual 12 – Balancing Operations

Revision 77 (08/27/2015):

- Added language in Section 1.1 to clarify the stakeholder notification process related to the creation of new closed loop pricing interfaces and the timing of their use to set Local Marginal Prices.
- Administrative Change: Updated references from edata to Data Viewer.

Revision 76 (08/03/2015):

- Conforming revisions for FERC Order ER15-1849, accepted on 7/23/15 and effective 8/3/15, to improve measurement and verification procedures for CSPs with Residential Demand Response Customers. Residential customers without interval metering may participate in the DA, RT, and SR market using the statistical sampling method detailed in Manual 19 Attachment D and subject to PJM approval (sections 4.2.8, 10.4.1, 10.5.2). Residential customers that do not participate in the Day Ahead market do not need to have the same LSE on economic registrations (sections 10.2.2, 10.5)
- Cleanup from a previous change in section 10.4.1: LSEs do not review meter data for DR.

Revision 75 (04/09/2015):

- Added second step on the reserve demand curves in section 2.5.5
- Added language in sections 4.2.2 to address the extension of the synchronized reserve requirement under certain emergency conditions
- Added language in sections 11.2.1 and 11.2.8 detailing the increase in the day-ahead scheduling reserve requirement under certain emergency conditions to account for the difference between fixed demand and forecasted load in the day-ahead market

Revision 74 (04/09/2015):

- Added language in section 2.3.2 and 2.3.7 for Demand Bid Screening Process that was implemented in Day-Ahead market.

Revision 73 (04/01/2015):

- Removal of revisions to section 2.3.2 Market Buyers, 2.3.3 Market Sellers, 2.9 The Calculation of Locational Marginal Prices (LMP) during Reserve Shortages and 2.15 Maximum Emergency Energy in the Day-Ahead Market effective 01/16/2015 – 03/31/2015 offer cap language conforming change related to Docket No. EL15-31-000.
- Administrative changes to Exhibit numbering.

Revision 72 (01/16/2015):

- Revisions to section 2.32 Market Buyers, 2.3.3 Market Sellers, 2.9 The Calculation of Locational Marginal Prices (LMP) during Reserve Shortages and 2.15 Maximum Emergency Energy in the Day-Ahead Market effective 01/16/2015 – 03/31/2015 offer cap language conforming change related to Docket No. EL15-31-000.

Revision 71 (01/01/2015):

- Section 2.3.3 and Attachment C– Added business rule regarding Intraday Cost Schedule updating. The effective date of the business rule is February, 2015
- Intermediate business rules for Manual Intraday Cost Schedule updating can be referenced at <http://www.pjm.com/markets-and-operations/etools/markets-gateway.aspx>

Revision 70 (01/01/2015):

- Section 2.3.6 – Added business rule regarding the commitment of long lead resources in the day-ahead market
- Section 4.2.2 – Added business rules surrounding the increase to the Primary Reserve Requirements under emergency procedures
- Section 11.2.3 – Updated the calculation of the DASR Offer quantity
- Other minor revisions to clean up formatting and references to retired applications

Revision 69 (10/30/2014):

- Sections 3.2.1 and 3.2.7 – Corrected typographical errors of mileage ratio to mileage, and multiply by to divide by
- Section 3.2.1 – Added business rules regarding Demand Resources that have overlapping commitments in Regulation and Load Management
- Section 4.2.1 – Added business rules around resources Tier 1 MW estimation in the clearing process, and Tier 1 MW credit when Non-Sync Reserve MCP is above zero
- Section 4.2.8 – Added business rules regarding Demand Resources that have overlapping commitments in Synchronized Reserves and Load Management

Revision 68 (08/21/2014):

- Updated section 2.8 to include new Pre-Emergency Load Management resource types that was accidentally not included in revision 67. Changes were approved at 8/21/14 MRC.

Revision 67 (06/01/2014):

- Section 2.3.2 added language detailing that PJM may require a specific bid limit volume on virtual bid/offer segments in the Day-ahead market.
- Section 2.3.4 added language detailing that PJM may require a specific bid limit volume on 'up to' congestion transactions in the Day-ahead market.
- Section 2.3.3 added requirement for units with notification and startup exceeding 24 hours to modify notification and startup time to allow unit to be committed in the Day-ahead Market if the unit was scheduled by PJM dispatch in advance of the close of the Day-ahead Market bidding period
- Section 4.2.2 added language detailing the increase of Synchronized Reserve and Primary Reserve requirements following Hot or Cold Weather Alerts or Maximum Generation Emergency Alerts to reflect additional reserves being carried to cover operational uncertainty.
- Section 11.2.1 added language detailing the increase of the Day-ahead Scheduling Reserve requirement following Hot or Cold Weather Alerts or Maximum Generation Emergency Alerts.
- Effective date 6/1/14 unless otherwise approved by FERC based on PJM compliance filing regarding the conforming manual changes for tariff changes approved in ER14-822-proceeding (improve DR resource operational flexibility). The DR operational changes for this manual include: (i) Section 10, requiring all Demand Resources participating in PJM's capacity market to serve as Pre-Emergency Load Response, unless the resource utilizes behind-the-meter generation that is subject to an environmental restriction; (ii) Section 10.4.5, limiting the duration of the required minimum load response reduction period from two hours to one; (iv) Section 2.3.3, establishing revised Demand Resource offer price caps which vary based on the registrations lead time.

Revision 66 (03/07/2014):

- Section 10.1 - included conforming language to tariff provisions approved under order 745 that customer baseline should represent what the load would have otherwise been and therefore settlements are not permitted for load reductions that would have otherwise occurred as part of normal operations.

Revision 65 (01/21/2014):

- Conforming changes to Docket No Docket No. ER14-373-000 approved on December 11, 2013 and approved by the PJM Markets and Reliability Committee on August 1, 2013. The changes are in section 2.3.4 and change the periods and requirements for parameter limited schedule exceptions.

Revision 64 (01/06/2014):

- Conforming changes to Docket No14-277 tariff changes approved on 12/17/13 by FERC and approved at 9/26/2013 by PJM Markets and Reliability Committee. The changes are in Section 10 and remove the requirement to include the LSE on PJM Emergency DR registrations.

Revision 63 (01/01/2014):

- Section 2.7 – Removing Regulation Marginal Benefits Factor from 5 minute LPC posting as directed by the FERC in ER12-1204.
- Section 3.2.7- Removing Regulation Marginal Benefits Factor from market settlements as directed by the FERC in ER12-1204.
- Section 3.2.10- Removing Regulation Marginal Benefits Factor and inserting Regulation Mileage Ratio into market settlements as directed by the FERC in ER12-1204 and consistent with Manual 28, Section 4.2.
- Section 4.2.1 – clarifying updates for the Tier 2 Synchronized Reserve must offer requirement.
- Section 4.2.4 – Rewording of Synchronized Reserve offer period.
- Section 4.2.12 – Augment language for Tier 2 Synchronized Reserve non-performance to a Synchronized Reserve Event.
- Section 7 – Updated link to retired Manual 41.

Revision 62 (8/30/2013):

- Section 10.4.2 updated to include 2 additional alternative CBLs: Same Day (3+2) and Match Day (3 day average).

Revision 61 (06/27/2013):

- Clarifying updates throughout sections 1, 2, 4 and 6 for shortage pricing.
- Section 3.2.9 documents that intra hour commitment or re-commitment for dual qualified regulation resources will continue to use the signal type (RegA or RegD) the resource cleared for the hour.
- Corrections to section 4
 - Rewording of section 4.2.7 for hydro synchronized reserve events.
 - Conforming change to section 4.2.12 from to Manual 12, Section 4.5.8 regulating resources responding to a synchronized reserve event should return to their regulating band within 10 minutes of the end of the event.
- Clarification added to Attachment C to address the number of cost schedules, add clarity to units that change fuels after their DA commitment or minimum runtime has been met and unforeseeable manning cost recovery.

Revision 60 (06/01/2013):

- Conforming changes to incorporate rules for Residual Zone Pricing as approved by FERC in Docket (s) ER13-347. Residual metered load pricing is effective 6/1/2015. Conforming revisions made to section 2.
- Updates for EKPC Market Integration:
 - Section 2.13: Added EKPC to Western Region BOR.

- Section 10.4.2: Added EKPC and DEOK to the weather station used for each Transmission Zone.

Revision 59 (04/01/2013):

The following changes were approved at the 3/28/13 MRC

- Changes to Section 2 outlining the allocation of Day-ahead Operating Reserve Credits for resources scheduled to provide Reactive Services or transfer interface control per Docket #ER13-418.
- Updated section 3.2.7 to provide refinement to the reduced energy ramp rate logic with the reduced ramp rate floor percent.

Revision 58 (3/1/2013):

- The following changes were approved at the 2/28/13 MRC.
 - Update section 10.2 to provide additional clarification on load reduction capability, business segment and generation attributes provided by CSPs.
 - Update section 10.2 to clarify and change the CSP duplicate registration resolution process.
 - Update section 10.4 to clarify how load reductions for emergency energy settlements are calculated and to determine rules for energy settlements when hourly emergency and economic event overlap. Update to section 10.4.5 are subject to FERC approval of corresponding tariff changes (expect to file in April and receive FERC decision by June 1, 2013).

Revision 57 (12/01/2012):

- Changes to Section 2.13 outlining the allocation of Operating Reserve Credits for the scheduling of units for Black Start service and testing of Black Start units.
- References to the eSchedules application were updated to InSchedule to reflect the recent upgrade and renaming of this PJM application.

Revision 56 (11/29/2012):

Section 4.2.9 updated for the following:

- Change language to require load data to be provided by CSP for all SR events and for all DR resources with an SR commitment.
- Change CSP load data submission deadline from 1 business day to 2 business days after the SR event,
- Include clarification that CSPs that fail to provide complete, accurate and timely load data may be suspended from participating in the Synchronized Reserve Market until corrective measures are implemented and may be referred to the PJM Market Monitor and/or the FERC Office of Enforcement for further investigation as necessary,

- Increase limit on DR resources from 25% of hourly SR requirement to 33% of the hourly SR requirement.

Revision 55 (10/25/2012):

- Conforming changes to incorporate rules for Shortage Pricing as approved by FERC in Docket (s) ER09-1063 and ER12-2262, effective 10/01/2012.
- Conforming revisions made to sections 2, 4, 5, & 6.
- An additional section created, Section 4b – Non-Synchronized Reserve Market, to incorporate new rules.
- Revisions endorsed by Markets & Reliability Committee on 10/25/2012.

Revision 54 (10/01/2012):

- Conforming changes to section 10 (demand response participation) based on order 745 (ER11-4106-000). Changes include DR compensation, cost allocation, CBL and associated approval process, elimination of self scheduling, implementation of dispatch group. Conforming changes to section 10 based on elimination of compensation based on LMP-G&T under NBT (ER12-1705-000). Conforming changes to section 10 based regulation market changes (ER12-1430) for demand response (Economic Regulation Only registration and ability to use additional CSP, modified aggregation rules for Economic Regulation Only registration and use of submeter load data to determine regulation performance. This change also included miscellaneous clean up and reformatting for section 10.

Revision 53 (10/01/2012):

- Added Section 12: Overview of the Price Responsive Demand. Conforming revisions for FERC Order ER11-4628 accepted on 12/14/2011 and effective 05/15/2012 to integrate Price Responsive Demand (PRD) in PJM Capacity Market.

Revision 52 (10/01/2012):

Based on FERC Order 755 for Frequency Regulation Compensation in the Organized Wholesale Power Markets encompassed in FERC Docket Nos. ER12-1204 and ER12-2391, the following changes were made to these sections in this Manual:

- Section 1.1 – PJM Responsibilities added detail about two-part regulation offer.
- Section 2.5 – Unit Dispatch System added detail about Regulation A and Regulation D.
- Section 3.1 – Overview of the PJM Regulation Market added detail about two-part regulation offer for capability and performance.
- Section 3.2.1 – Regulation Market Eligibility added detail about cost and price offers under the new two-part offer for capability and performance.
- Section 3.2.1 – Regulation Market Data Timeline added detail about two part regulation offer.

- Section 3.2.4 – Regulation Requirement Determination edited section to refer back to Manual 12, Section 4.4.3 Determining Regulation Assignment.
- Section 3.2.6 – Regulation Offer Period added detail about cost and price offers under the new two-part offer for capability and performance.
- Section 3.2.7 – Regulation Market Clearing and Dispatch added detail about two-part regulation offer for capability and performance and their impact on offer adjustment, three pivotal supplier test, lost opportunity cost, benefits factor and market clearing.
- Section 3.2.8 – Hydro Units reorganized to mirror corresponding language in Manual 28, Section 4.2 Regulation Credit.
- Section 3.2.9 – Regulation Market Operations added detail about two-part regulation offer for capability and performance.
- Section 3.2.10 – Settlements added detail about two-part regulation settlement for capability and performance including the use of the marginal benefit factor, as well as, hourly performance threshold of 25%.
- Section 5.2.7 – ASO edited section to reflect the new Ancillary Service Optimizer engine, which replaces SPREGO.
- Section 6.1.1 – PJM Regulation Requirement edited section to refer back to Manual 12, Section 4.4.3 Determining Regulation Assignment.

Revision 51 (08/08/2012):

- Add bullet to 3.2.1 to clarify priority of the regulation signal and economic dispatch.
- Add subsection Dispatch to 3.2.7 for the reduced energy ramp rate check to prevent units from over ramping when following both regulation and economic dispatch. Also added a check on the set points based on the MW output of the resource.

Revision 50 (04/03/2012):

- Add bullet to Section 2.3.3 pointing to Manual M-28 regarding make whole provisions for generators committed in the Day-ahead Market and not run in real-time.
- Republished 04/12/2012 to remove an erroneous bullet point that had stated: “A Generator that has been notified of a restriction due to a projected reliability condition, should not submit an economic maximum or maximum emergency bid into the Day-Ahead market higher than the communicated restriction. A forced outage ticket should be entered into eDART (Outside Management Control) for the duration of the restriction.?”

Revision 49 (01/01/2012):

- Revisions made to reflect integration of the DEOK zone into the PJM footprint.

Revision 48 (10/20/2011):

- Revision made to change the Synchronized Reserve Market interface from APSOUTH to the most limiting monitored transfer interface

- Revision made to the Synchronized Reserve maximum such that it can be less than or equal to the economic maximum for qualified resources that are granted exception due to a physical limitation
- Revision made to include Tier2 Synchronized Reserve floor offer of 0.1 MW in section 4.2.1

Revision 47 (10/20/2011):

- Updated Section 3.2.1 to state that both Generation and Demand Resources must be able to provide 0.1 MW of Regulation Capability in order to participate in the Regulation Market.

Revision 46 (06/01/2011):

- Revisions made to reflect integration of the ATSI zone into the PJM footprint.

Revision 45 (06/23/2010):

- Revisions approved by stakeholders at MRC on June 23, 2010 to incorporate changes due to PJM markets manuals review.
- Revisions made to clarify that PJM will be the counterparty to all transactions, unless market participants expressly and mutually contract between themselves (or self schedule to themselves). Revisions have been approved at the Markets and Reliability Committee on April 21, 2010 and by FERC (Order ER10-1003 issued on May 5, 2010) (Reference: [FERC Order ER10-1003](#))

Revision 44 (01/01/2010):

- Revisions approved by stakeholders at MRC on November 11, 2009 to incorporate the following revision:
- One CSP rule (Section 10)

Revision 43 (9/24/2009):

- Revised Section 2: Overview of Two-Settlement System section to reflect revisions to rules for submitting PLS, as approved by, as approved by the Markets & Reliability Committee on September 23, 2009

Revision 42 (07/31/2009)

- Revised Section 2: Overview of Settlement System section to reflect Balancing Operating Reserve construct change as approved by FERC (ER08-1569).
- Revised Section 2: Overview of Settlement System to incorporate revisions to allow generators with negative offers to set price in the Day-ahead Market during a Minimum Generation event, as approved by the Markets & Reliability Committee on July 30, 2009
- Revised Section 10: Overview of Demand Response Participation to incorporate enhancement to DSR economic aggregation rules for resources providing Ancillary Services, as approved by the Markets & Reliability Committee on July 30, 2009

Revision 41 (06/18/2009)

- Revisions to Section 3 to incorporate rules as approved by FERC on March 29, 2009 (Docket No. ER09-789) to allow for the recovery of lost opportunity costs incurred by generating market buyers and market sellers during the hour preceding the initial regulating hour and the hour following the final regulation hour.
- Cleanup revision on page 121.

Revision 40 (03/18/2009):

- Revision to Section 10 to change the current rule requiring a participating end-use customer site have only one Curtailment Service Provider. Revision approved by Markets Reliability Committee on April 23, 2009.

Revision 39 (03/18/2009):

- Revisions to Section 10 for Interval Meter Equipment and Load Data Requirements for DSR resources, Revisions approved by the Markets and Reliability Committee on March 18, 2009. Interval Meter Equipment and Load Data Requirements become effective on **October 1, 2009**.

Revision 38 (01/15/2009):

- Revised Section 3 to incorporate rules to implement the Three Pivotal Supplier Test in the Regulation Market as approved by FERC (ER09-013) on November 26, 2008.
- Revisions to Section 10 to incorporate Customer Usage Information Form

Revision 37 (11/24/2008):

- Revised Synchronized Reserve Market rules to allow recalculation of Tier 1 Synchronized Reserve estimates 60 minutes prior to the market hour [as approved by MRC on June, 2008]

Revision 36 (08/06/2008):

- Revised offer capping rules to eliminate exemptions per FERC Order EL08-34 (Effective May 16, 2008). Revisions made to Section 2.
- Revised terminology for revised RFC Definition for Bulk Electric System (BES). Revisions made to Sections 1, 11 & 9.
- Created new Section 11: Overview of Day-ahead Scheduling Reserve Market to incorporate markets rules approved per FERC Order ER08-780 (Effective May 30, 2008). Additional revisions made to Sections 1, 2, 5 & 6 for consistency.
- Revised the Regulation Market Requirement to calculate on and off peak values. Revisions made to Sections 3 & 6.

Revision 35 (06/13/2008):

- Section 10: Demand Resources Participation

- Revised Demand Response Participation Rules effective June 13, 2008 for calculation of Customer Baseline (CBL) and associated rules per FERC Order ER08-824.

Revision 34 (2/29/2008):

- Corrected typographical error made in Revision 33 on page 23.

Revision 33 (02/21/2008):

- Section 2 – Revisions to reflect changes to the business rules for ‘up-to-congestion’ transactions.

Revision 32 (09/28/2007):

- Section 2 – Revisions to reflect changes to the Day-ahead modeling of external bilateral transactions to put the generator or load (for import or export respectively) at the interface point.

Revision 31 (06/01/2007):

- Revisions for the implementation of Marginal Losses
- Revisions for the implementation of the Reliability Pricing Model

Revision 30 (03/20/2007):

- Section 2: Clarifying changes for consistency
- Section 3: Clarifying changes to reflect the implementation of Mixed-Integer Programming (MIP) in SPREGO optimization. Clarifying changes to reflect posting of Regulation Market Results.
- Section 4: Clarifying changes to reflect the implementation of Mixed-Integer Programming (MIP) in SPREGO optimization. Clarifying changes to reflect posting of Synchronized Reserve Market Results.
- Section 4: Revised rules to reflect the requirements of Demand Resources that are considered “batch load?”
- Section 4: Revised rules to reflect Synchronized Reserve Market Consolidation for Reliability First Corporation.
- Section 5: Clarifying changes for terminology
- Section 6: Clarifying changes for consistency and terminology
- Section 6: Clarifying changes to reflect the scheduling process for External Market Sellers (XIC Units)
- Revision History permanently moved to the end of the manual.

Revision 29 (08/11/2006):

- Exhibit 1: Updated to include the new Manual 30: Alternative Collateral Program.

- Section 2: Revised rules to clarify the determination of a resource's hourly Desired MWh value and no-load compensation values.
- Section 7: Timing requirement updates made regarding ramp reservations that are not scheduled against and ramp reservations that are placed In-Queue.
- Added new section (Section 10) for Demand Response Participation

Revision 28 (06/13/06):

- Revised Ancillary Services Rules for DSR.
- Revised Ancillary Services Rules for RFC.
- Revised for Three Pivotal Supplier rules.

Revision 27 (05/12/06):

- Section 7: Overview of External Transaction Scheduling
- Removed exception for spot import service.
- Revisions were made to the following pages: 101 and 106.

Revision 26 (11/09/05):

- Section 7: Overview of External Transaction Scheduling
- Revised wording in paragraph 1 to reflect PJM's compliance with NERC Standard INT-001.

Revision 25 (08/19/05):

- Section 3: Overview of PJM Regulation Market
- Revised PJM Regulation Market Business Rules to create a single regulation market for the PJM RTO effective August 1, 2005.

Revision 24 (05/09/05):

- Section 3: Overview of PJM Regulation Market
- Revised PJM Regulation Market Business Rules to identify Ancillary Services Market Areas for Market Integration.
- Revised PJM Spinning Reserve Market Business Rules to define Southern Spinning Reserve Requirement.
- Section 4: Overview of the PJM Spinning Reserve Market
- Revised PJM Spinning Reserve Market Business Rules to identify Ancillary Services Market Areas for Market Integration.
- Revised PJM Spinning Reserve Market Business Rules to define Southern Spinning Reserve Requirement.
- Section 7: External Transaction Scheduling
- Revised expiration times for reservations that are not scheduled against that are made to start the following day.

Revision 23 (12/7/04):

- Section 2: Overview of PJM Settlement System
- Changed PJM Settlement Business Rules for to allow Unit Modeling Changes quarterly.

Revision 22 (10/01/04):

- Section 2: Overview of PJM Settlement System
- Changed PJM Settlement Business Rules for Virtual Bidding at External Interfaces
- Added PJM Settlement Business Rules for modeling multiple units for operating reserve calculations.
- Section 3: Overview of PJM Regulation Market
- Changed PJM Regulation Market Business Rules to identify Ancillary Services Market Areas
- Added/Changed PJM Regulation Market Business Rules for Market Integration
- Changed PJM Regulation Market Business Rules to define Main/ECAR regulation requirement
- Changed PJM Regulation Market Business Rules to define new information supplied through the Settlement Market User Interface
- Section 4: Overview of the PJM Spinning Reserve Market
- Changed PJM Spinning Reserve Market Business Rules to identify Ancillary Services Market Areas
- Added/Changed PJM Spinning Reserve Market Business Rules for Market Integration

Revision 21 (01/31/04):

- Created a new section (Section 7: External Energy Scheduling)
- Revised Exhibit 1: List of PJM Manuals to reflect additional manuals which have been created in 2003.

Revision 20 (09/01/03):

- Section 1: Overview of Scheduling Operation
- Revised exhibit 2.
- Section 2: Overview of PJM Settlement System
- Revised exhibit 2.
- Section 3: Overview of PJM Regulation Market
- Changed High Regulation Limit to Regulation Max
- Changed Low Regulation Limit to Regulation Min
- Section 4: Overview of the PJM Spinning Reserve Market

- Changed PJM Spinning Reserve Market Business Rules to define new information supplied through the Settlement Market User Interface: Condense Startup Cost, Condense Hourly Cost, Condense Notification Time, and Spin as Condenser.
- Added Spinning Reserve Market Business Rule regarding Balancing Operating Reserves for units that are pool-assigned Tier 2 spinning reserve.
- Section 5: Scheduling Philosophy and Tools
- Revised exhibit 4.
- Added exhibit 5.
- Revised exhibit 12.
- Revised exhibit 13.
- Removed all Attachments
- Attachment A: Markets Database Dictionary has been removed
- The Markets Database Dictionary provides PJM market participants with definitions for each of the data elements in the Markets Database. The Markets Database is an Oracle database that replaced the PJM unit commitment database. It is the repository of all generation offers, demand bid data and schedules for the Day-ahead Energy Market, Real-time Energy Market, Regulation Market, and Spinning Reserve Market. The Markets Database Dictionary can be found on the PJM Web site at <http://www.pjm.com/etools/downloads/emkt/market-database-data-dictionary.pdf>.
- Attachment B (Offer Forms) has been deleted since the forms are no longer used
- Attachment C (eMKT User's Guide) has been removed
- The PJM eMKT Users Guide provides market participants with the information needed to participate in the PJM settlement, regulation markets and spinning reserve markets. The user guide describes the settlement software, the spinning reserve and regulation software, and the tasks that market participants can perform, as well as the expected system responses. The eMKT Users Guide can be found on the PJM Web site at <http://www.pjm.com/documents/downloads/user-guides/ts-userguide.pdf>
- Attachment D (Source & Sink List) has been removed
- Instructions on how to download the valid sources and sinks for the Day-ahead Energy Market can be found in the PJM eMKT Users Guide. The eMKT Users Guide can be found on the PJM Web site at <http://www.pjm.com/documents/downloads/user-guides/ts-userguide.pdf>
- Participants can also download the PJM Network Model information from the PJM Web site at www.pjm.com/markets/energy-market/bus-price-model.html.
- Attachment E: Interchange Energy Schedule Curtailment Order
- This attachment has been renamed "Attachment A.?"
- Attachment F: External Interface Specification Guide has been removed

- The External Interface Specification Guide is intended to help market participants in the PJM settlement, regulation and spinning reserve markets who want to develop their own interfaces for exchanging market data with PJM instead of using the default Market User Interface provided in PJM. The External Interface Specification Guide can be found on the PJM Web site at <http://www.pjm.com/services/training/downloads/externalspecs1.pdf>.

Revision 19 (12/01/02):

- Revised Attachment E: Interchange Energy Schedule Curtailment Order.

Revision 18 (12/01/02):

- Revised Attachment E: Interchange Energy Schedule Curtailment Order.

Revision 17 (12/01/02):

- Added new Section 4: Overview of the PJM Spinning Reserve Market.
- All remaining sections re-numbered respectively.

Revision 16 (05/18/01):

- Revised Section 2: Overview of the PJM Settlement System. Updated 'Market Sellers' subsection to include rules involving the designation of Maximum Emergency and Maximum Economic generation, numbered items 22 and 23, respectively.

Revision 15 (02/01/01):

- Revised Section 5: Scheduling Strategy & Method. Under subsection 'External Transactions', updated 60/45/30 minute rule to the new 60/30/20 minute rule. Also added bullet: "Hourly transactions will only be accepted after 1600 EPT (1400 EPT on non-business days) of the day before the Operating Day. Lastly, listed under 'Validating and Confirming Transaction Requests', a bullet was added to read:
 - "Ensure a valid NERC Tag has been associated. A valid NERC Tag is one in which?:
 - The profile is entirely covered by the tag
 - The tag duration is not longer than the schedule
 - The tag does not overlap profiles within a schedule
 - The tag is not used for multiple schedules
- Removed Attachment A: Definitions and Abbreviations, and all references. Attachment A is being developed into a new PJM Manual for Definitions and Abbreviations (M-35). All remaining attachments have been renumbered and all references have been corrected.

Revision 14 (08/24/00):

- Revised Section 5: Scheduling Strategy & Method. In subsection "Processing Market Information?", added text pertaining to Deviations from Day-ahead Market for Pool Scheduled Resources, and Credits for Cancellation of Pool Scheduled Resources.

Revision 13 (08/15/00):

- Revised Section 5: Scheduling Strategy & Method. Added text pertaining to Ramp Violations.

Revision 12 (07/25/00):

- Revised Section 5: Scheduling Strategy & Method.

Revision 11 (06/16/00):

- Attachment F: Interchange Energy Schedule Curtailment Order
- Revised Curtailment of Capacity Backed Resources.
- Capacity Backed Exports are those transactions sourced from generators or portions of generators on the PJM system that are not designated as PJM installed capacity.
- At Maximum Emergency, PJM will not recall any energy from a resource that is not included in PJM Installed Capacity. If a resource has been de-rated from summer peak capacity, any export that exceeds the pro-rated capacity not attributed to PJM will be reduced to that pro-rated level.
- Example: Unit A has a summer rated capacity of 80 MW, where 60 MW is designated as installed capacity and 20 MW is not. A 20 MW export is scheduled from PJM. There is no outage on the unit. The full 20 MW export will be scheduled.
- Example: Unit A has a summer rated capacity of 80 MW, where 60 MW is designated as installed capacity and 20 MW is not. If there is a 40 MW partial outage of the unit, 3/4 (or 60/80) of the remaining capacity is considered installed. 1/4, or 20/80, of the remaining capacity is available as non-installed capacity and will not be curtailed during a PJM Maximum Emergency. In this example 30 MW remains as PJM installed capacity and 10 MW remains available for capacity backed exports. If the owner of Unit A scheduled a 20 MW export, 10 MW could be recalled during PJM Maximum Emergency. At the conclusion of Maximum Emergency or at the conclusion of the outage, the export would be restored to the full 20 MW.

Revision 10 (06/01/00):

- Attachment F: Interchange Energy Schedule Curtailment Order
- Removed Non-Firm over Secondary Points schedules requested after 2:00 p.m. of the day before operations and Non-Firm schedules requested after 2:00 p.m. of the day before operations from curtailment order.
- Added category: Curtailment of Capacity Backed Resources.

Revision 09 (06/01/00):

- Revised to reflect the Multi-Settlement Process implementation.

Revision 08 (04/01/00):

- Attachment B: Unit Commitment Database

- Removed reference to Maximum Scheduled Generation in section Unit Commitment – Scheduling Data (Cost Capped) for Steam Unit and Schedule Data #7 Schedule Operating Data.
- Removed reference to Maximum Scheduled Generation in section Unit Commitment – Scheduling Data (Cost Capped) CT Unit and Schedule Data #5 Unit & Schedule Operating Data.
- Removed reference to Maximum Scheduled Generation in section Unit Commitment – Scheduling Data (Cost Capped) Diesel Unit Data #5 Schedule Operating Data.

Revision 07 (06/01/99):

- Section 3: Scheduling Strategy & Method
- Revised to reflect the new addition of Attachment F (see below).
- Added 'new' Attachment F: Interchange Energy Schedule Curtailment Order.

Revision 06 (10/06/98):

- Section 3: Scheduling Strategy & Method
- Guidelines and requirements for the submission of Offer Data, and confirmation and PJM acceptance of schedules/transactions under "Spot Market Energy" and "Bilateral Transactions" of "Processing Market Information" were revised.

Revision 05 (04/01/98):

- Attachment C: Offer Forms
- Added "Exhibit C.7: Market Seller Aggregate Bid for Non-Designated Resource (E-Schedules Contracts)"
- Attachment E: Source & Sink List
- Added Attachment E: Source & Sink List
- Section 1: Overview of Scheduling Operations
- Revised exhibits and text.
- Section 2: Scheduling Philosophy & Tools
- Revised exhibits and text.
- Section 3: Scheduling Strategy & Method
- Added exhibits and text describing Locational Marginal Pricing application to the Scheduling process.
- Section 4: Posting OASIS Information
- Revised exhibits and text.
- Section 5: Hourly Scheduling
- Revised exhibits and text.

Revision 04 (01/30/98):

- Section 3: Scheduling Strategy & Method
- Changed PJM contact phone numbers for receipt of Offer Data to include 610.666.4532
- under “Spot Market Energy.” Added
- “A schedule is not accepted without confirmation of the schedule details with all parties.
- External offers are subject to the 500 MW ramp rule. The ramp rules outlined under “Bilaterals” in this section apply to offers.”
- under “Spot Market Energy.” Added
- “Offers Submitted More Than One Day in Advance
- Offers may be submitted up to seven (7) days in advance (e.g., a bid for the tenth of the month could be submitted as early as the third of the month).
- Offers submitted more than one day in advance received after 12:00 noon will not be processed until the following day.
- Spot Market offers submitted more than one day in advance are not considered binding until 12:00 noon of the day before operations.
- Ramp room will be held for the schedule, but neither PJM nor the market participant is bound to the schedule before 12:00 noon of the day before the operating day. Up to this time, either party may decline the offer without penalty.
- A change to one day of a multi-day offer nullifies the timestamp for the rest the offer. The offer will be given a new timestamp and scheduled as though the rest of the schedule was submitted at the time of the change (including ramp room).
- Transmission reservations that are not used due to cancelled spot market offers will be subject to transmission charges as appropriate.
- PJM will notify the submitter of the acceptance status of offers submitted more than one day in advance by 4:00 p.m. of the day before operations or earlier as specified by the submitter. No offer will be marked as accepted before 12:00 noon of the business day before the operating day.
- Offers may be withdrawn before PJM notifies the PJM Member of bid acceptance and before 4:00 p.m. of the business day before operations or 12:00 noon of the non-business day before operations.”
- under “Spot Market Energy.”
- Changed heading “Data Requirements” from “Aggregate Offer Data Requirements.” under “Spot Market Energy.”
- Changed
- “identity of all parties that are engaged in the schedule (e.g., buyers, sellers, marketers, transmitters, and brokers)?
- from

- “identity of all parties that are engaged in the Bilateral Transactions (e.g., buyers, sellers, marketers, transmitters, and brokers)?
- under “Data Requirements? in “Spot Market Energy.?
- Changed
- “Offers may be withdrawn before PJM notifies the External PJM Member of bid acceptance and before 4:00 p.m. of the business day before operations or 12:00 noon of the non-business day before operations. All offers for the same period from the same Market Seller of a higher price than the withdrawn offer are also considered withdrawn.?
- from
- Offers may be withdrawn before PJM notifies the External PJM Member of bid acceptance and before 4:00 p.m. A withdraw of a bid after either of the aforementioned result in a non-delivery charge, unless withdrawing a resource specific offer due to a forced outage demonstrated to the satisfaction of the PJM. All offers for the same period from the same Market Seller of a higher price than the withdrawn offer are also considered withdrawn.
- under “Data Requirements? in “Spot Market Energy.?
- Changed
- “If the discrepancies are resolved without change to the original Bilateral Transaction request by 4:00 p.m., the schedule status is marked as confirmed. If discrepancies are resolved with changes to original Bilateral Transaction request before the scheduling deadline, the time stamp is updated to the time at which the discrepancies are resolved with the PJM.?
- from
- “If the discrepancies are resolved without change to the original Bilateral Transaction request by 4:00 p.m., the schedule status is marked as confirmed. If discrepancies are resolved with changes to original Bilateral Transaction request before 2:00 p.m., the time stamp is updated to the time at which the discrepancies are resolved with the PJM.?
- under “Confirmation of Bilateral Transactions? in “Bilateral Transactions.?
- Attachment C: Offer Forms
- Changed PJM contact phone numbers for receipt of Offer Data to include 610.666.4532.

Revision 03 (01/01/98):

- Section 3: Scheduling Strategy & Method
- Changed “The Regulation Requirement for the PJM Control Area is defined as follows:
- PJM -specified percentage of the PJM Valley Load Forecast (currently 1.1%). This requirement is in effect during the Off-Peak Period (0000-0459 hours).
- PJM -specified percentage of the PJM Peak Load Forecast (currently 1.1%). This requirement is in effect during the On-Peak Period (0500-2359 hours).?
- from “The Regulation Requirement for the PJM Control Area is defined as follows:

- PJM -specified percentage of the PJM Valley Load Forecast (currently 1.1%). This requirement is in effect during the Off-Peak Period (2300-0659 hours).
- PJM -specified percentage of the PJM Peak Load Forecast (currently 1.1%). This requirement is in effect during the On-Peak Period (0700-2259 hours).?
- Changed Exhibit 3.2: Regulation Requirement Timeline.
- Attachment D: Process Diagrams
- Added “Attachment D: Process Diagrams.?”

Revision 02 (09/23/97):

- Changed selected references to PJM Member to market participant.
- Changed PJM phone number for receipt of Offer Data during business hours from “610-666-8947?” to “610-666-4548.?”
- Changed PJM phone number for checking Offer Data during non-business hours from “610-650-4307?” to “610-666-4510.?”
- Changed PJM phone number for receipt of Bilateral Transactions (North/West) during non-business hours from “610-666-8807” to “610-666-4510.?”
- Section 1: Overview of Scheduling Operations
- Revised “(2) Unmetered Market Buyer - An Unmetered Market Buyer is a Market Buyer that is making purchases of energy from the PJM Interchange Energy Market for consumption by metered end-users or end-users that are located outside the PJM Control Area.?” in “Market Buyers?” under “PJM Member Responsibilities.?”
- Revised “purchase transmission capacity reservation in order to receive generation from PJM Interchange Energy Market if the energy is being delivered to end-users that are located outside the PJM Control Area?” in “Market Buyers?” under “PJM Member Responsibilities.?”
- Section 2: Scheduling Philosophy & Tools
- Deleted “verifies that transmission service exists?” in “Transaction Management System?” under “Scheduling Tools.?”
- Revised “The deadline for both internal and external participants to submit information for the next day is 12:00 Noon of the previous PJM business day. After this deadline, no further offers are accepted for the next day and the UCDB is locked. The deadline is only extended when there is a computer problem at the PJM?” in “Marginal Scheduler?” under “Scheduling Tools.?”
- Section 3: Scheduling Strategy & Method
- Revised “(4) PJM notifies via ALL-CALL, of the PJM Regulation Requirement?” in “PJM Actions?” under “PJM Regulation Requirements.?”
- Revised “ (6) PJM notifies via ALL-CALL, in the event of a Regulation Requirement shortage?” in “PJM Actions?” under “PJM Regulation Requirements.?”

- Revised “Each PJM Member, that has a requirement to serve load within the PJM Control Area, provides the PJM with a forecast of its requirements by 1200 hours on the day before the Operating Day. Regardless of how the PJM Member’s load is supplied, the PJM Member submits the following Operating Day forecast information to the PJM: in “PJM Member Load Forecasts? under “Processing Market Information.?”
- Revised “Each PJM Member makes its own choice based on the information it possesses. Exhibit 3.5 illustrates the relationship between self- and PJM -scheduling for a particular resource? in “Self-Scheduled Resources? under “Processing Market Information.?”
- Revised heading “Buy/Sell Request for External Energy? to “Spot Market Energy? under “Processing Market Information.?”
- Revised “Spot Market requests are in the form of offers. There are general requirements for offer data, as well as specific requirements for internal and external participants? in “Spot Market Energy? under “Processing Market Information.?”
- Replaced “Internal offers must be resource specific unless a schedule with an internal (metered) participant is agreed to beforehand. This is because PJM must account for every MW of energy within the PJM Control Area? with “A PJM Member must be in possession of the power to sell it as Spot Market energy (i.e., no entity can be in the contract path between the PJM Member selling the energy and PJM)? in “Spot Market Energy? under “Processing Market Information.?”
- Added “PJM does not accept bids where the PJM Interchange Market is the source and sink (e.g., PJM-Market Participant-PJM)? in “Spot Market Energy? under “Processing Market Information.?”
- Added “PJM does not accept bids for less than one continuous hour? in “Spot Market Energy? under “Processing Market Information.?”
- Revised “PJM does not accept offers for resources committed to supply Operating Reserves to another Control Area. PJM will not double count units internal to PJM for Operating Reserves. If energy is being offered from a resource to PJM and is already included in the PJM Operating Reserve, the energy can be accepted but will not participate in PJM Operating Reserve accounting. Offers not properly submitted are rejected. The PJM Member is notified of the reason for rejection and the PJM Member may then take action to submit a new offer? in “Spot Market Energy? under “Processing Market Information.?”
- Revised heading “Internal PJM Member Requirements? to “Resource Specific Offer Data Requirements? in “Spot Market Energy? under “Processing Market Information.?”
- Deleted heading “External PJM Member Requirements? in “Spot Market Energy? under “Processing Market Information.?”
- Deleted “External PJM Members submit offer data via both telephone and facsimile; numbers are listed under General Requirements. External PJM Members use the forms found in Attachment C to submit offers? in “Spot Market Energy? under “Processing Market Information.?”

- Deleted “External Market Buyers submit the following data, for the next operating day only:
- specific amount of energy for each hour of the day
- dispatch rate above which it does not desire to purchase OASIS number (the “transaction? number from the “Buy/Sell ATC? page of the PJM OASIS. More details on procedures for making a transmission service request via the PJM OASIS can be found on the PJM OASIS Users Guide @ <http://oasis.pjm.com>) for the transmission service reservation(s) which will be used to deliver the energy for the desired point of receipt of the intention to purchase transmission if the offer is accepted?
- in “Spot Market Energy? under “Processing Market Information.?
- Deleted “Valid offers are entered into the Transaction Maintenance System (TMS) for analysis by the Marginal Scheduler? in “Spot Market Energy? under “Processing Market Information.?
- Deleted “complete energy path? in “Spot Market Energy? under “Processing Market Information.?
- Added heading “Aggregate offer Data Requirements? and the following text in “Spot Market Energy? under “Processing Market Information.?:
- “Aggregate offer data shall be submitted via both telephone and facsimile; phone numbers are listed under General Requirements. External PJM Members use the forms found in Attachment C of this manual to submit offers.
- A request to change offer data after an offer has been accepted (e.g., dispatch level, dispatch rate, path) will be rejected.
- PJM Members delivering Spot Market Energy to the PJM Interchange Energy Market submit the following data for the next operating day only:
- identity of all parties that are engaged in the Bilateral Transaction (e.g., buyers, sellers, marketers, transmitters, and brokers)
- minimum and maximum dispatch levels for each hour
- identity of any neighboring External Control Area identifiers and priorities, if applicable
- dispatch rate above which it does not desire to sell
- PJM Members requesting Spot Market Energy from the PJM Interchange Energy Market submit the following data for the next operating day only:
- identity of all parties that are engaged in the Bilateral Transaction (e.g., buyers, sellers, marketers, transmitters, and brokers)
- minimum and maximum dispatch levels for each hour
- dispatch rate above which it does not desire to purchase
- For Spot Market Energy to be delivered external to the PJM Control Area, OASIS number (the “transaction? number for the “Buy/Sell ATC? page of the PJM OASIS - More details on procedure for making a transmission service request via the PJM OASIS can be found on the PJM OASIS Users Guide @ <http://oasis.pjm.com>) for the transmission service

reservation(s) which will be used to deliver the energy for the desired point of receipt or the intention to purchase transmission if the offer is accepted.

- identity of any neighboring External Control Area identifiers and priorities, if applicable?
- Deleted “External Market Sellers reports the following data for aggregate offers, the next operating day, up to the next business day only:
 - complete energy pay
 - dispatch rate below which it does not desire to sell
 - hours of energy availability
 - minimum and maximum dispatch levels?
- in “Spot Market Energy? under “Processing Market Information.?”
- Deleted “This data constitutes a binding offer. Valid offers are entered into the Transaction Maintenance System (TMS) system for analysis by the Marginal Scheduler? in “Spot Market Energy? under “Processing Market Information.?”
- Revised “Aggregate Offer Data - PJM compares the offer characteristics to the forecasted system conditions and Marginal Scheduler output. See “Forecasting PJM Generation Requirement? in Section 3 of this manual for more information? in “Spot Market Energy? under “Processing Market Information.?”
- Revised “Resource Specific Offer Data Evaluation - Resource Specific Offer Data remains in Marginal Scheduler for evaluation. If the offer is not accepted before or during the operating day, the offer is considered rejected? in “Spot Market Energy? under “Processing Market Information.?”
- Revised “If an offer is accepted or rejected, the PJM Member is notified via phone and fax. A confirmation fax is sent to the PJM Member (see Attachment C). For any accepted offer the PJM Member is notified by telephone by PJM as soon as possible. For External PJM Members, the contact information requested on the fax form (Attachment C) must be listed on the offer facsimile? in “Spot Market Energy? under “Processing Market Information.?”
- Added heading “Non-Delivery of Spot Market Energy? and the following text in “Spot Market Energy? under “Processing Market Information:?”
- “A PJM External Market Seller will not be assessed a non-delivery charge if participants were not able to provide delivery for one or more of the following valid and documented reasons which physically prevented delivery and which was not reasonably anticipated at the time of scheduling:
 - transmission system constraints prevented delivery
 - generation outages of source generator(s) (resource must be specified in original Offer)
 - supplier or intervening power system emergencies prevent delivery
- A PJM External Market Buyer will not be assessed a non-delivery charge if the participant was prevented from delivery by one or more of the three conditions described above, the participant subsequently attempted to reschedule delivery, and PJM was unable to comply with the timing requirements for continuity of the transaction.

- Non-delivery charges described in Section 1.6.5 and 1.6.6 of Attachment K of the Tariff will continue to be assessed for all other non-delivery situations.
- The interface path of a Spot Market Energy schedule will not be changed on-shift (hourly).?
- Changed heading “Data Requirements Involving PJM Members External to PJM?” to “Data Requirements Involving Parties External to PJM?” in “Bilateral Transactions?” under “Processing Market Information.?”
- Revised “If a transaction is reported after 2:00 p.m. of the business day before the operating day, the transaction uses non-firm transmission, congestion is expected on the system, and the transaction might contribute to the congestion, the request for the transaction will not be accepted. These schedules are submitted to the non-business hours facsimile or telephone number provided above.” in “Bilateral Transactions?” under “Processing Market Information.?”
- Added “valid NERC TIS Tag?” in “Bilateral Transactions?” under “Processing Market Information.?”
- Deleted “identity of all PJM Members that are engaged in the Bilateral Transaction (e.g., buyers, sellers, marketers, transmitters, and brokers)?” in “Bilateral Transactions?” under “Processing Market Information.?”
- Deleted “type of transaction (wheel in, wheel out, losses, firm, non-firm)?” in “Bilateral Transactions?” under “Processing Market Information.?”
- Deleted “scheduled start/stop dates and time?” in “Bilateral Transactions?” under “Processing Market Information.?”
- Deleted “quantity of service by hour (maximum and minimum MW) in increments of 1 MW/hour (1,000 kW/hour)?” in “Bilateral Transactions?” under “Processing Market Information.?”
- Deleted “identity of any neighboring External Control Area identifiers and priorities?” in “Bilateral Transactions?” under “Processing Market Information.?”
- Revised “identity of associated transmission service reservation(s) for each hour of the Bilateral Transaction. This is the “transaction?” number on the “Buy/Sell ATC?” page of the PJM OASIS. Only one transmission service reservation may be applied to one energy schedule in any given hour. More details on procedures for making a transmission service request via the PJM OASIS can be found on the PJM OASIS Users Guide at <http://oasis.pjm.com>?” in “Bilateral Transactions?” under “Processing Market Information.?”
- Added “identity of any neighboring External Control Area identifiers and priorities?” in “Bilateral Transactions?” under “Processing Market Information.?”
- Revised “Bilateral Transactions scheduled for delivery to native load must be submitted by the Market Participant that reserved the Transmission Service or the LSE. The LSE ultimately receiving the energy and the Market Participant that reserved the Transmission Service must both confirm the Bilateral Transaction. All parties to the transaction must confirm the transaction?” in “Bilateral Transactions?” under “Processing Market Information.?”

- Added “valid NERC TIS Tag is received (see www.nerc.com)?” in “Bilateral Transactions?” under “Processing Market Information.?”
- Revised “valid energy transaction type (firm, non-firm, wheel in, wheel out, loses)?” in “Bilateral Transactions?” under “Processing Market Information.?”
- Revised “if using non-firm transmission, then transaction must be reported to PJM before 2:00 p.m. of the business day before the operating day?” in “Bilateral Transactions?” under “Processing Market Information.?”
- Added heading “Additional Validations for a Bilateral Transaction Schedule using On-Peak or Off-Peak Transmission Service Reservations?” in “Bilateral Transactions?” under “Processing Market Information.?”
- Added Exhibits 3.10, 3.11, 3.12 and 3.13 in “Bilateral Transactions?” under “Processing Market Information.?”
- Added heading “Frequently Asked Questions (regarding on-peak and off-peak energy scheduling)?” and the following text in “Bilateral Transactions?” under “Processing Market Information.?”
- “(Q1) A Market Participant has reserved off-peak daily transmission for Wednesday, but ramp room is not available at 0700 or 2300.
- (A1) Two possible solutions are 1) the energy may be scheduled from 0000 to 0800 or 2) the energy may be scheduled from 0000 to 0715 and from 2315 to 2400.
- (Q2) A Market Participant has reserved on-peak weekly transmission. Ramp room is available from 0700 to 2300 Tuesday through Friday, but ramp room is not available at 0700 or 2300 on Monday.
- (A2) The energy may be scheduled 0700 to 2300 Tuesday through Friday. One solution to the Monday ramp limit would be to schedule the energy from 0645 to 2245.?”
- Deleted “Because Internal Bilateral Transactions do not cross a PJM interface, the 500 MW ramp rule does not apply to these transactions. Internal Bilateral Transactions are entered before the energy is scheduled to start. If a participant does not have direct access to TMS, the PJM Member can request PJM to confirm the transaction in TMS?” in “Bilateral Transactions?” under “Processing Market Information.?”
- Revised “identity of all parties that are involved in the Bilateral Transaction (e.g., buyers, sellers, marketers, wheelers, and brokers)?” in “Bilateral Transactions?” under “Processing Market Information.?”
- Section 4: Posting OASIS Information
- Replaced “Bilateral Transactions?” with “transmission service reservations?” under “PJM OASIS.?”
- Revised “(1) Not later than 1600 hours of the day before each Operating Day, PJM posts the following information:?” in “PJM Actions?” under “PJM OASIS.?”
- Attachment C: Offer Forms
- Revised PJM phone numbers on all forms.

- Added “For Internal Use?” fields to Exhibits C.1, C.3 and C.4

Revision 01 (07/08/97):

- Section 2: Scheduling Philosophy & Tools
- Deleted “... (both those electing to curtail due to congestion and those electing to pay congestion charges) ...?” under “Transaction Management System.”
- Section 5: Hourly Scheduling
- Deleted “... (not paying congestion charges) ...?” under “Hourly Scheduling Adjustments.”

Revision 00 (05/01/97):

- Changed references to PJM Interconnection Association to PJM Interconnection, L.L.C.
- Changed references to PJM to PJM buses where appropriate.
- Changed references to PJM to PJM Control Area where appropriate.
- Changed references to PJM IA to PJM.
- Changed references to IA to PJM.
- Changed references to Mid-Atlantic Market to PJM Interchange Energy Market.
- Changed references to Mid-Atlantic Market Operations Agreement to Operating Agreement of PJM Interconnection, L.L.C.
- Changed references to pool to control area.
- Changed references to parties to PJM Members.
- Changed references to External Market Participant to Non-Metered PJM Member.
- Changed references to Internal Market Participant to Metered PJM Member.

Revision 00 (03/21/97):

- This revision is a draft of the PJM Manual for ***Scheduling Operations***.